



**Elesi Luce<sup>®</sup>**

# Materioteca

## Materials library

# Codici e simboli

## Code and symbols

### Finiture galvaniche / Galvanic finishes



**AC** Acciaio spazzolato  
Brushed steel

**OF** Oro francese  
French Gold

### Finiture materiche / Textured finishes

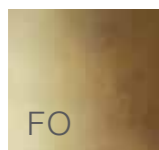

**FO** Foglia oro  
Gold foil

### Finiture verniciate / Painted finishes

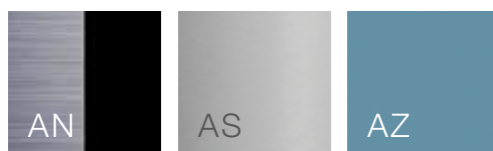

**AN** Alluminio spazzolato + nero  
Brushed Aluminium + black

**AS** Alluminio spazzolato  
Brushed aluminium

**AZ** Azzurro  
Azure

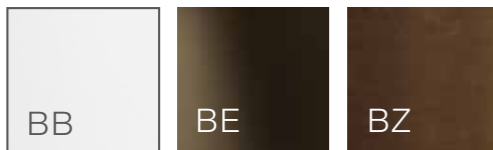

**BB** Bianco  
White

**BE** Bronzo opaco  
Matte bronze

**BZ** Bronzo spazzolato  
Brushed bronze

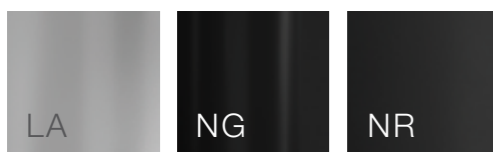

**LA** Alluminio liscio  
Smooth aluminium

**NG** Nero glossy  
Glossy Black

**NR** Nero  
Black



**OL** Ottone lucido  
Brass color

**ON** Ottone spazzolato + nero  
Brushed brass + black

**OS** Ottone spazzolato  
Brushed brass



**RF** Rosa metallizzato  
Metallic light pink

**TN** Titanio  
Titanium

**VS** Verde salvia  
Sage green

### Applicazione / Use pictograms



### Caratteristiche / Specific pictograms

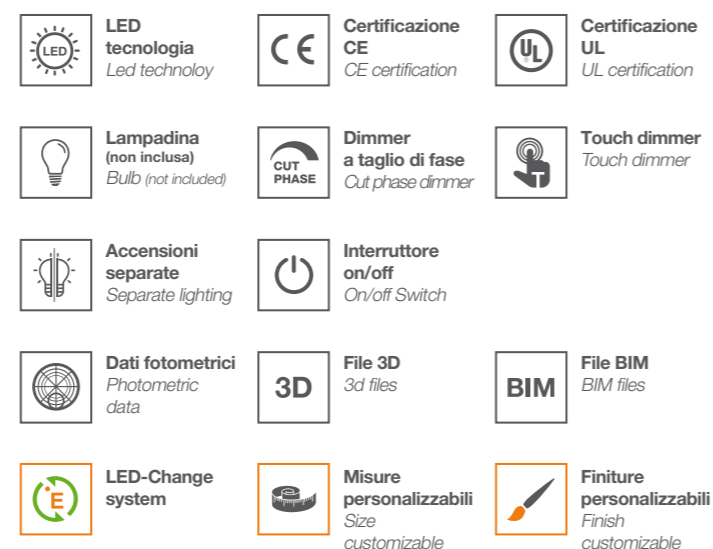

### Costruzione del codice / Code Construction

- Codice prodotto di 5 cifre**  
Product code **02009**
- Finitura della struttura**  
Structure finish **02009 OF**
- Sistema di dimmerazione**  
Kind of dimmer **02009 OF D**
- Colore luce LED**  
LED light color **02009 OF D W**
- Ottica della lente**  
Lens degree **02009 OF D W X**
- Grado di protezione IP**  
IP rate **02009 OF D W X X**
- Finitura del diffusore**  
Diffuser color **02009 OF D W X X NR**

# Our Nature is Light

# Elesi Luce®

## Catalogo / Catalog

*“Ci lasciamo ispirare dal mondo che ci circonda, dalla luce che crea atmosfere e suggestioni sempre nuove”*

Osserviamo la bellezza che ci circonda e la portiamo nel nostro studio creativo. Collaboriamo con designers per arricchirci di nuovi punti di vista e proporre soluzioni estetiche e tecniche di valore. Lampade che diano la giusta luce e forma al tuo ambiente e al tuo progetto.

*“We get inspired by the world around us, by the light creating ever-changing atmospheres and suggestions”*

We admire the beauty around us and we bring it in our creative lab. We collaborate with designers to be enriched by new points of view and to propose new valuable aesthetic and technical solutions. Lamps able to give the proper light and shape to your environment and your project.





*“Attraverso la qualità della luce ci prendiamo cura del benessere delle persone”*

*“We take care of people’s well-being through the quality of light”*

Maurizio Betteto



Tutte le lampade Elesi Luce sono disponibili in 3 colori di bianco per consentire di scegliere la luce migliore in base all’ambiente di utilizzo e alle preferenze personali.

*Every Elesi Luce’s light source is available in 3 colours of white to enable people to choose the most suitable light according to each environment and to individual preferences.*

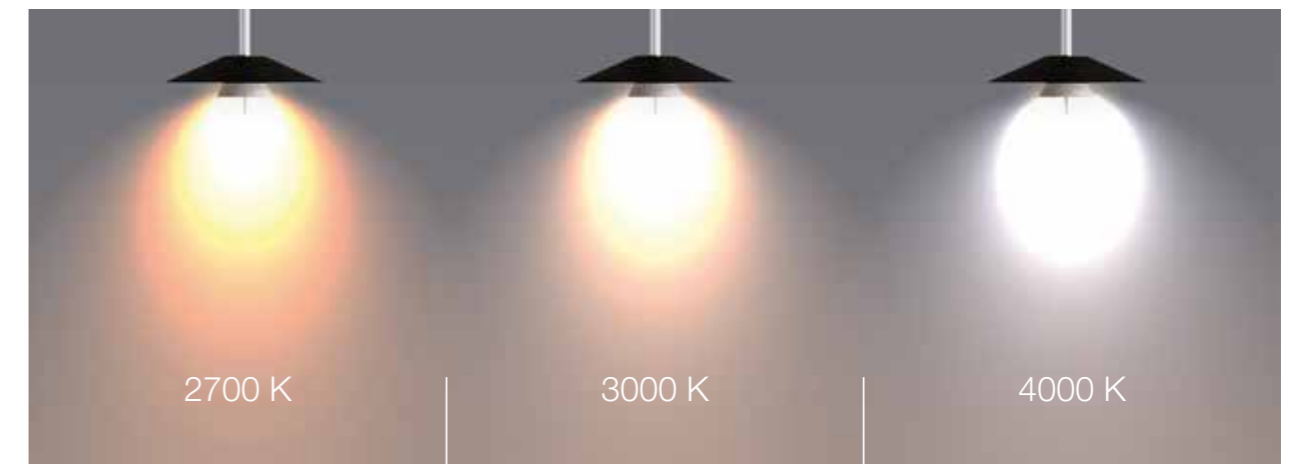

La luce esalta i colori se l’indice di resa cromatica è adeguato, per questo motivo Elesi Luce utilizza LED con CRI  $\geq 90$ .

*Light enhances colours if the colour rendering is appropriate. That is why Elesi Luce uses LED with CRI  $\geq 90$ .*



CRI 80

CRI 90



*“Progettando prodotti ecosostenibili ci prendiamo cura dell’ambiente e del futuro del pianeta”*

*“We take care of the environment and of the future of our planet designing eco-friendly products”*

*Silvia ed Elena Betteto*



Ci prendiamo cura dell’ambiente realizzando lampade che durano nel tempo. La soluzione sviluppata da Elesi Luce si chiama Led Change System che consiste in soluzioni per la sostituzione facilitata del led integrato.

*We take care of the environment manufacturing lamps that last over time. The solution developed by Elesi Luce is called Led Change System, practical solutions for an easy inbuilt LED replacement.*

**I vantaggi per il cliente / The advantages for the customer:**

Assistenza facile e veloce, diminuzione dei costi, aumento del ciclo di vita del prodotto, riconoscimento del diritto alla riparazione.

*An easy immediate support, a reduction of the restoration costs, a longer product life cycle, the recognition of the right to repair.*

**I vantaggi per il pianeta / The advantages for the planet:**

Riduzione dei rifiuti, diminuzione dei consumi, utilizzo responsabile di materie prime.

*A reduction of waste, a decrease in consumption, a low usage of raw materials.*

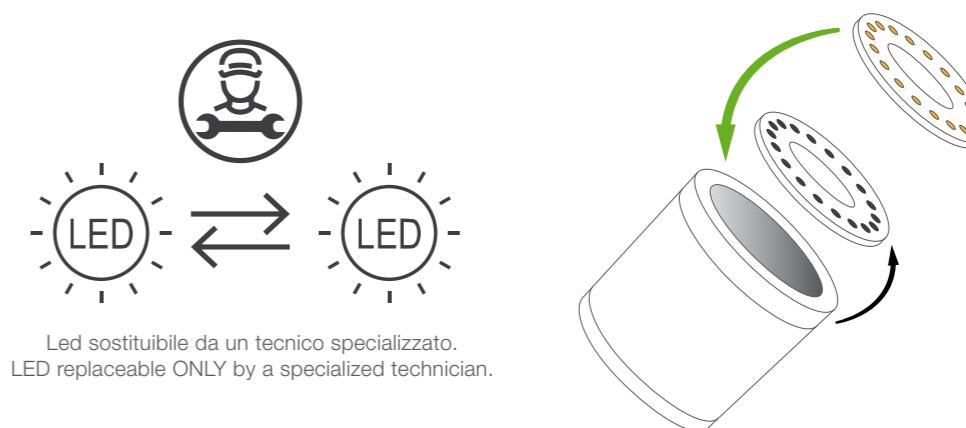

**Come funziona / How it works:**

Alla richiesta di assistenza verrà spedito il pezzo di ricambio con istruzioni dettagliate per la sostituzione. Le lampade progettate con Led Change System sono contrassegnate nel catalogo con questo pittogramma:

On demand, the spare part will be delivered along with the detailed instructions for the replacement. The lamps designed by LED-Change system are marked with this pictogram in the catalog





*“Persone capaci ed esperte si prendono cura di ogni dettaglio durante tutte le fasi della produzione.”*

Questo è il significato di artigianalità in Elesi Luce, la cura del dettaglio in ogni suo aspetto. Il tutto supportato da una organizzazione dei dati informatizzata secondo gli standard Industria 4.0 e controllata dal sistema certificato di qualità ISO 9001:2015.

*“Skilled people with expertise take care of each detail during all production phases”*

This is the meaning of craftsmanship at Elesi Luce, the attention to detail in every aspect. Everything supported by an organisation of information and of the processes according to Industry 4.0 standards and supervised by ISO 9001:2015 Quality Management System Certification.





*“Una città tesoro di cultura e arte, che incanta i suoi visitatori. Venezia con la sua unicità rappresenta il nostro territorio”*

Il Veneto, una regione ricca di storia e arte tra mare e monti. Abbiamo scelto di progettare e produrre in questo territorio per poter conservare e far crescere il know how che da secoli caratterizza questo meraviglioso luogo. Produzione Made in Italy, ispirazione universale.

*“A timeless city, a treasure of culture and art, that enchants its visitors. Venice represents our territory by its uniqueness”*

Veneto, a region full of history and art between sea and mountains. We chose to design and manufacture in this territory to preserve and develop the know-how that has distinguished this wonderful area for ages. Made in Italy production, universal inspiration.





Alba



Pg. 16

Gaia



Pg. 78

Imperfetto



Pg. 28

Like Q



Pg. 104

Medusa



Pg. 40

Plettro



Pg. 120

Iconic



Pg. 50

Rondaj



Pg. 130

Bianca



Pg. 70

Quid



Pg. 140

Air

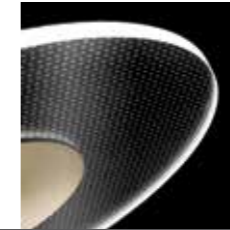

Pg. 150

Doc

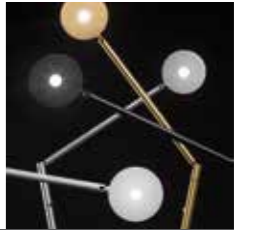

Pg. 212

Pois



Pg. 164

Dado



Pg. 220

Mir



Pg. 176

Eviva Plus



Pg. 232

Aura



Pg. 184

Composizioni



Pg. 250

Narciso



Pg. 196

*“Forme sottomarine, incontri di linee,  
giochi di figure, collezioni che nascono dal mare”*

*L'aria salmastra, la brezza, lo sciabordio delle onde svuotano la mente  
da ogni pensiero e ci rendono liberi di immaginare.*

Alba / Imperfetto / Medusa / Iconic

*“Underwater shapes, encounters of lines,  
game of forms, collections inspired by the sea”*

*The salty air, the breeze, the lapping of the waves empty the mind  
of all thoughts and make us free to imagine.*



# Alba

Designer: Roberto De Santi

“La luce che disegna la forma”  
“Light designs form”



**DESIGN** Alba rappresenta l'intimo legame tra luce e forma. La figura di appartenenza, il cerchio, non si conclude nella forma tangibile ma si dilata nello spazio.

**DESIGN** Alba represents the intimate link between light and form. The design is based on a circle, an incomplete figure stretching into space.



**PERSONALITÀ** L'effetto creato dalla lampada richiama il valore ancestrale della luce nel suo apparire. Una forma sospesa e leggera che si esalta con la luce. I led integrati ad alta efficienza e l'alluminio riciclabile la rendono una lampada a basso impatto ambientale.

**PERSONALITY** The effect created recalls the ancestral values of light as it appears at dawn. A suspended lightweight form enhanced by light. The high efficiency integrated LEDs and the recyclable aluminium make it a product with a low environmental impact.



**MAESTRIA** Per esaltare il colore naturale della luce, la parte interna della lampada è sempre color bianco. La rifinitura esterna può essere personalizzata.

**EXPERTISE** To enhance the natural colour of the light, the inner part of the lamp is always white. The outer finish can be customized.



Alba è stata inserita nel catalogo ADI DESIGN INDEX 2022, una selezione di prodotti d'eccellenza che rappresentano il design Made in Italy nel mondo.

The ADI Permanent Design Observatory selected Alba for the catalogue ADI Design Index 2022, a selection of the best Italian design project 2022.





Art 05001 OL



Art 05001 OL







Art 05002 BB



Art 05001 LA







Art 05003 BB

**05001**

Suspension 120cm  
 12 up - 23 down W  
 1700 up-3300 down Lumen  
 CRI90

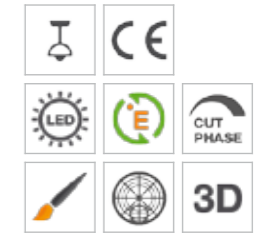

**05002**

Suspension 180cm  
 18 up-34 down W  
 2550 up-4900 down Lumen  
 CRI90

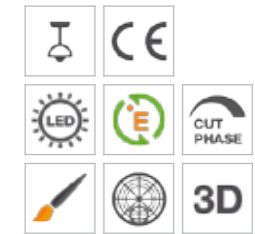

**05003**

Wall lamp  
 3,75 up-7,3 down W  
 550 up-1000 down Lumen  
 CRI90

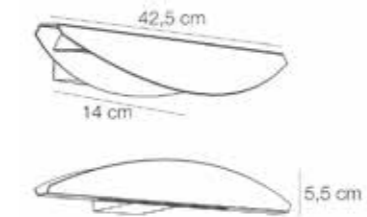

Structure	Dimmer	Led Light	Lens	IP	Diffuser
BB <input type="checkbox"/>	<b>D</b> (Dimmer)	<b>H</b> 2700 K <input checked="" type="radio"/>	<b>U</b> (UGR19)	<b>X</b> (IP20)	BB <input type="checkbox"/>
LA <input type="checkbox"/>		<b>W</b> 3000 K <input type="radio"/>			
NR <input type="checkbox"/>		<b>N</b> 4000 K <input type="radio"/>			
OL <input type="checkbox"/>					



# Imperfetto

Designer: Simone Bellicini

“La costante ricerca di equilibrio”  
“A constant search for balance”



**DESIGN** Imperfetto nasce dallo studio di inclinazioni simmetriche e asimmetriche che, nel movimento, cercano e raggiungono l'equilibrio perfetto. Un incontro di solidi diversi, che creano una propria armonia di forme.

**DESIGN** Imperfetto is the result of the research on both symmetrical and asymmetrical inclinations that look for and achieve the perfect balance in the movement. A match of various solids creating their own harmony of shapes.



**PERSONALITÀ** Diversa da ogni prospettiva, lascia cogliere un nuovo dettaglio di sé da ogni punto da cui si osserva. Imperfetto è un elemento di arredo, per sua natura protagonista. Il contrasto dei colori ne esalta le finiture.

**PERSONALITY** Different from each perspective, it unveils a new own detail from each possible viewpoint. Imperfetto is a piece of furniture thanks to its protagonist features. The colour contrast enhances its finishes.



**MAESTRIA** È il risultato di una accurata ricerca stilistica e meccanica che, su richiesta, può ospitare la tecnologia avanzata ELIV, sistema di controllo wi-fi e vocale semplice e intuitivo elaborato da Rete di Imprese Luce in Veneto.

**EXPERTISE** It is the outcome of a refined stylistic and mechanical study that, upon request, can host the cutting-edge technology ELIV: a wi-fi and voice control system, plain and user-friendly, made by Rete di Imprese Luce in Veneto.







Art 05202 VS (Version E27 Art 05232 VS)

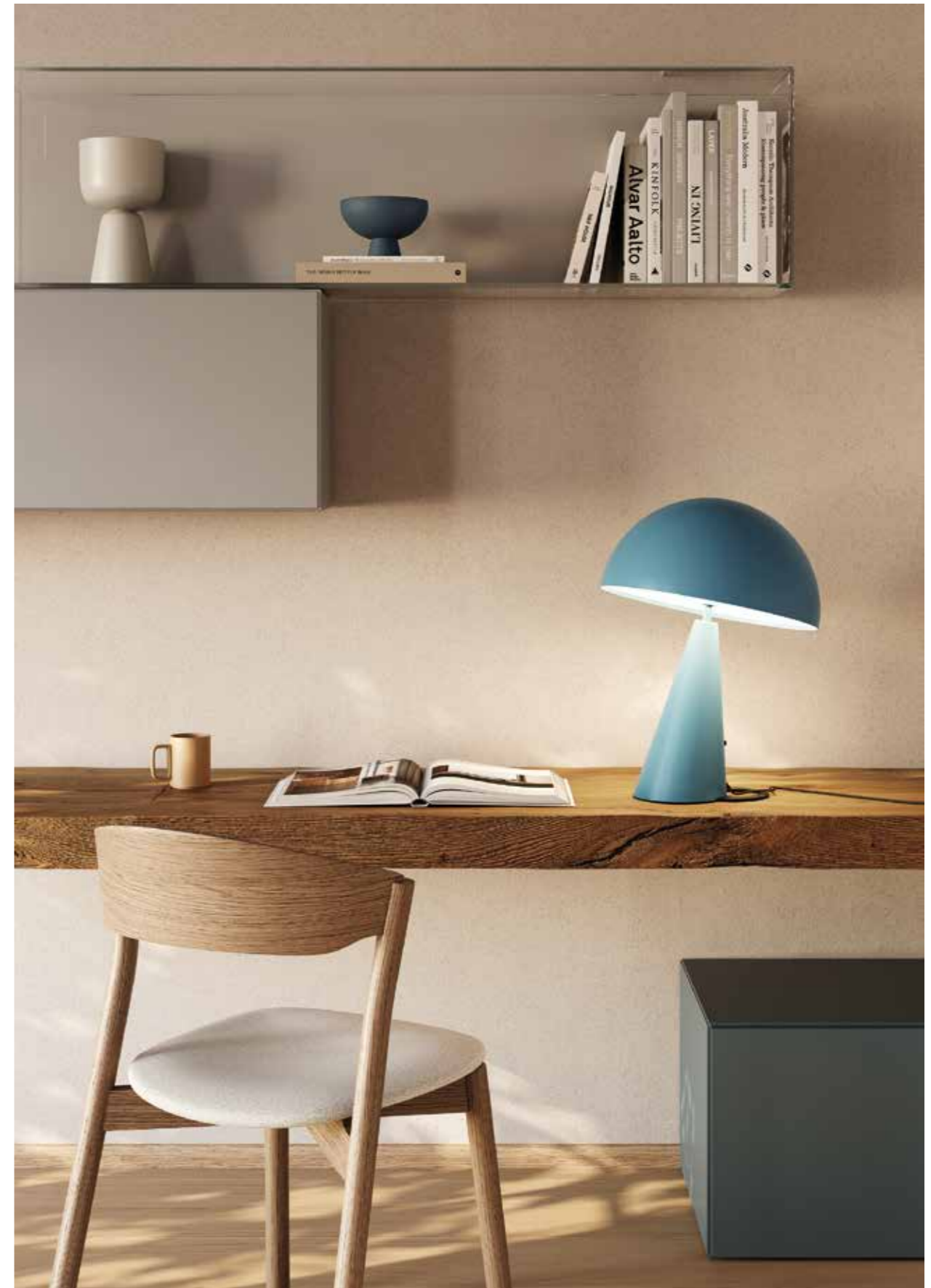

Art 05202 AZ (Version E27 Art 05232 AZ)



Art 05201 BE (Version E14 Art 05231)

Art 05202 BE (Version E27 Art 05232)



Art 05201 RF (Version E14 Art 05231 RF)





Art 05202 ON (Version E27 Art 05232 ON)

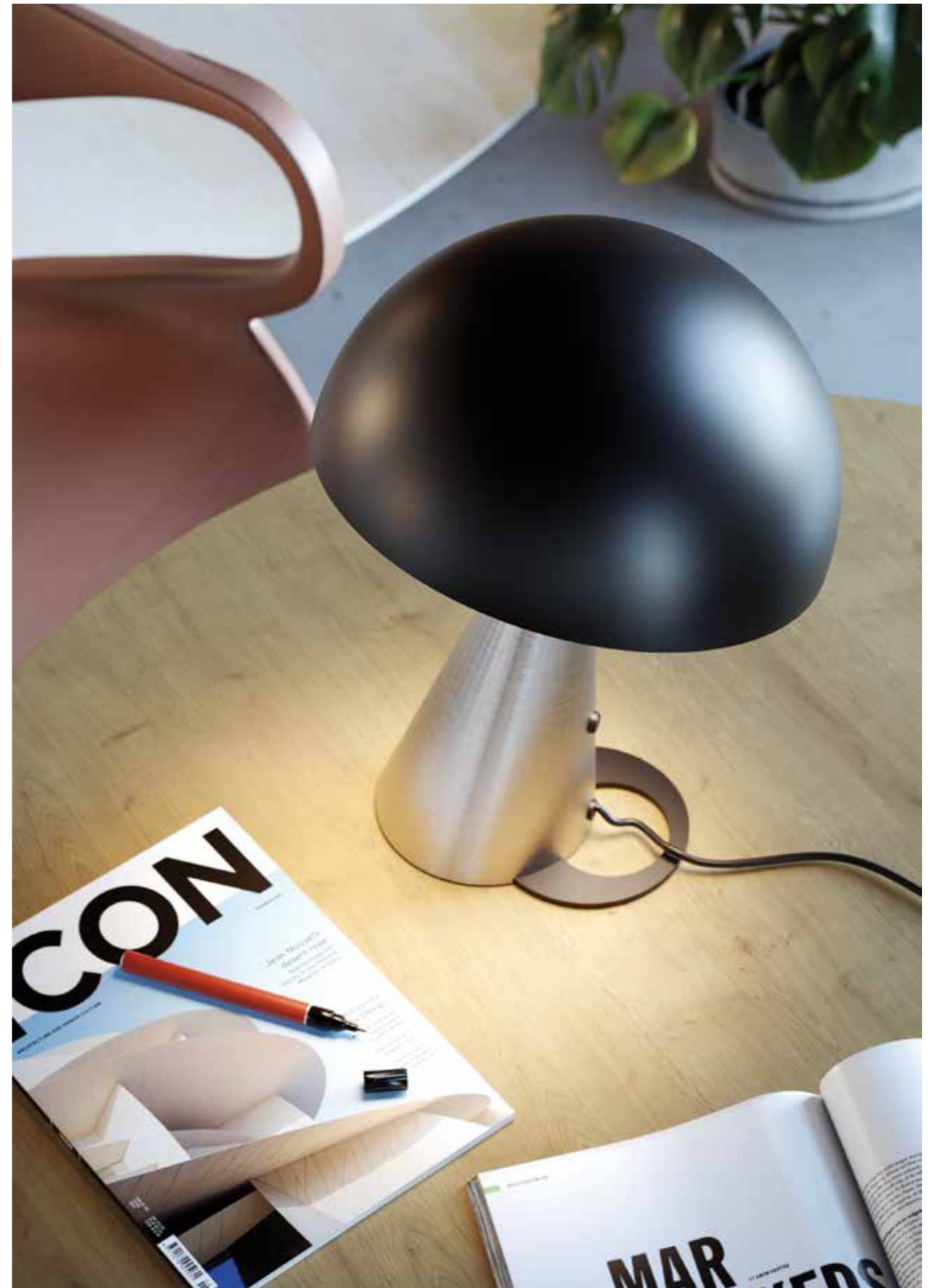

Art 05201 AN (Version E14 Art 05231 AN)



Art 05202 OS (Version E27 Art 05232 OS)





05201

Table lamp  
18 W  
2300 Lumen  
CRI90

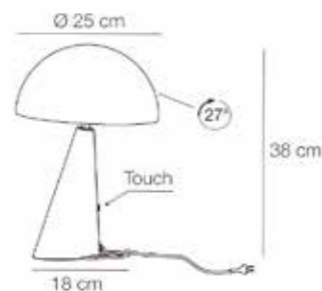

05201

Table lamp  
18 W  
2300 Lumen  
CRI90

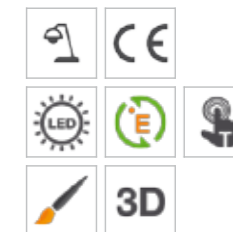
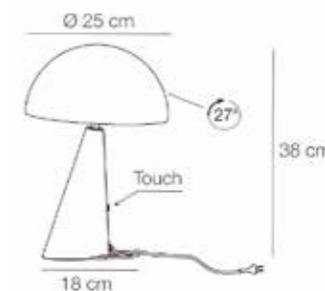

05202

Table lamp  
18 W  
2300 Lumen  
CRI90

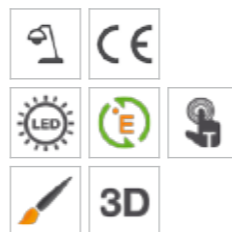
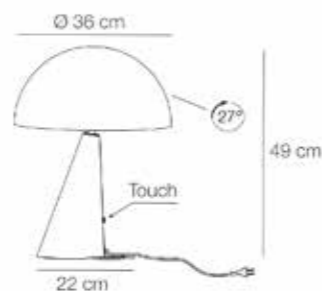

05202

Table lamp  
18 W  
2300 Lumen  
CRI90

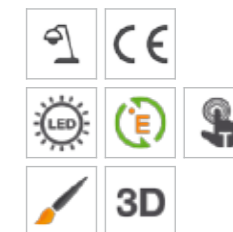
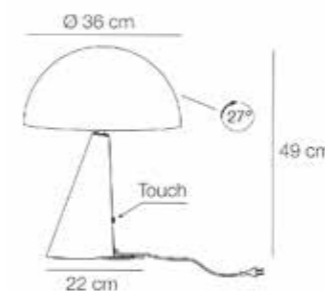

05231

Table lamp  
E14 2x6 W  
Lampadina non inclusa  
Bulb not included

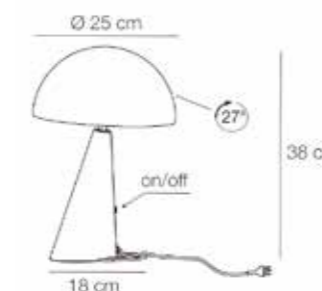

05231

Table lamp  
E14 2x6 W  
Lampadina non inclusa  
Bulb not included

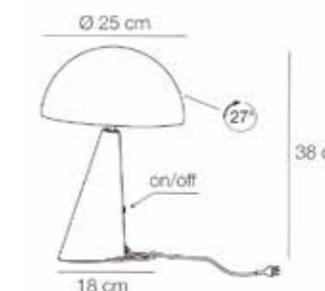

05232

Table lamp  
E27 2x13 W  
Lampadina non inclusa  
Bulb not included

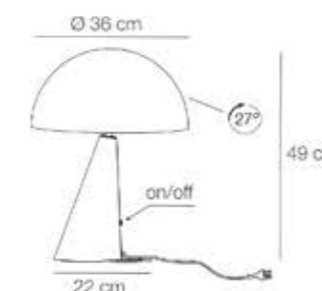

05232

Table lamp  
E27 2x13 W  
Lampadina non inclusa  
Bulb not included

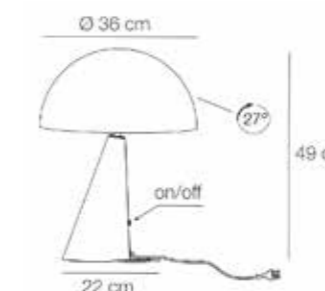

Structure	Dimmer	Led Light	Lens	IP	Diffuser
AN	<b>T</b> (Touch)	<b>H</b> 2700 K	<b>X</b> (No lens)	<b>X</b> (IP20)	<b>XX</b>
AS	<b>X</b> (No Dimmer)	<b>W</b> 3000 K			
BE		<b>N</b> 4000 K			
ON					
OS					

Structure	Dimmer	Led Light	Lens	IP	Diffuser
AZ	<b>T</b> (Touch)	<b>H</b> 2700 K	<b>X</b> (No lens)	<b>X</b> (IP20)	<b>XX</b>
NR	<b>X</b> (No Dimmer)	<b>W</b> 3000 K			
RF		<b>N</b> 4000 K			
VS					

# Medusa

Designer: Debonademeo

“Evocativa ispirazione dal mondo sottomarino”  
“Evocative inspiration from the underwater world”



**DESIGN** La silhouette eterea delle meduse viene evocata da una combinazione di sfere di metallo e cilindri in vetro canneté. Nasce così Medusa, una collezione essenziale ma poetica, che prende ispirazione dal mondo subaqueo.

**DESIGN** *The ethereal silhouette of jellyfish is evoked by a combination of metal spheres and canneté glass cylinders. Medusa, an essential but poetic collection, which takes inspiration from the underwater world.*



**PERSONALITÀ** Forma e dimensione sono una costante delle lampade della collezione che è caratterizzata dalla forte personalità delle finiture. Le mezze sfere possono anche combinarsi per corrispondenza cromatica o per contrasto a scelta del cliente.

**PERSONALITY** *Shape and size are a constant of the lamps in the collection which is characterized by the strong personality of the finishes. The half spheres can also be combined by color matching or by contrast at the customer's choice.*



**MAESTRIA** Vetro rigato lavorato a mano con bordo arrotondato, liscio esternamente e satinato internamente, diffonde in modo omogeneo la luce nell'ambiente.

**EXPERTISE** *Hand-worked ribbed glass with rounded edge, smooth on the outside and satin-finished on the inside, it evenly diffuses the light in the surrounding space.*







3x Art 05401 NG / 3x Art 05402 OL



Art 05402 RF

Art 05401 RF



Art 05403 LA

Art 05404 RF

Art 05403 NG





Art 05406 OL



Art 05405 NG

05401

Suspension  
7 W  
1100 Lumen  
CRI90

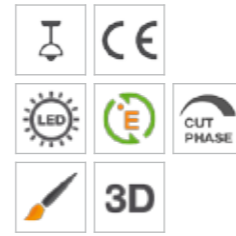
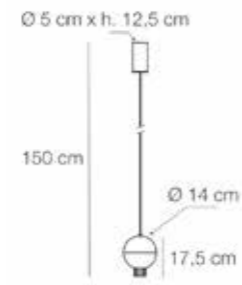

05402

Suspension  
7 W  
1100 Lumen  
CRI90

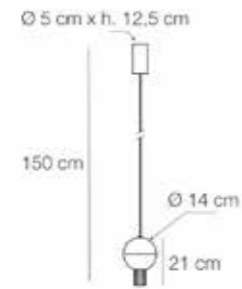

05403

Ceiling lamp  
7 W  
1100 Lumen  
CRI90

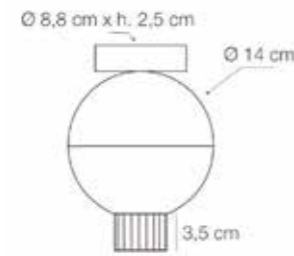

05404

Ceiling lamp  
7 W  
1100 Lumen  
CRI90

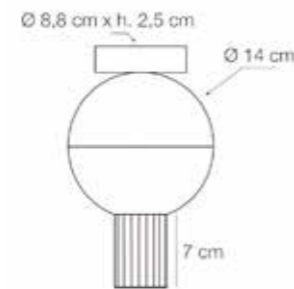

Structure	Dimmer	Led Light	Lens	IP	Diffuser
LA	<b>D</b> (Dimmer)	<b>H</b> 2700 K	<b>X</b> (No lens)	<b>X</b> (IP20)	ST
NG		<b>W</b> 3000 K			
OL		<b>N</b> 4000 K			
RF					

05405

Suspension  
7 W  
1100 Lumen  
CRI90

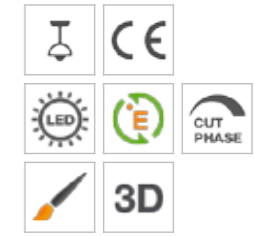
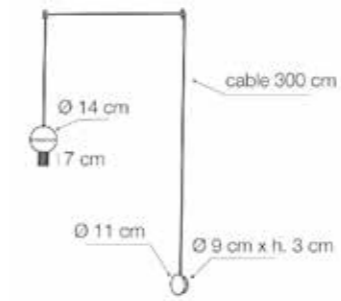

05406

Suspension  
3x7 W  
3x1100 Lumen  
CRI90

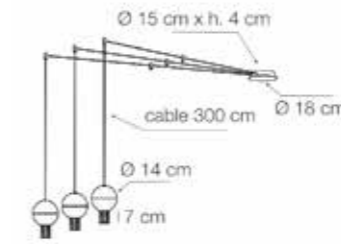

Structure	Dimmer	Led Light	Lens	IP	Diffuser
LA	<b>D</b> (Dimmer)	<b>H</b> 2700 K	<b>X</b> (No lens)	<b>X</b> (IP20)	ST
NG		<b>W</b> 3000 K			
OL		<b>N</b> 4000 K			
RF					



# Iconic

Designer: Simone Bellicini

“L’equilibrio di figure essenziali”  
“The balance of essential figures”



**DESIGN** Un incontro di forme essenziali. Attraverso una meccanica di precisione, un cilindro, un cono e una sfera si fondono per creare un elemento di design raffinato e iconico.

**DESIGN** A meeting of essential forms. Precision engineering helps to blend a cylinder, a cone and a sphere to create an elegant iconic design element.



**PERSONALITÀ** Iconic illumina gli ambienti rispecchiando il tuo stile grazie ai suoi elementi modulari che permettono di realizzare soluzioni personalizzate. L’alluminio riciclabile della struttura e il led integrato la rendono a tutti gli effetti una lampada sostenibile.

**PERSONALITY** With its modular elements that allow customized solutions, Iconic reflects your style. The recyclable aluminium structure and integrated LED make this a sustainable lighting product.



**MAESTRIA** La cura nel dettaglio si esprime nell’alluminio e ottone attraverso la spazzolatura del metallo eseguita completamente a mano. Quell’artigianalità che conferisce unicità a ciascuna lampada.

**EXPERTISE** Attention to detail in the 100% hand-brushed aluminium and brass, an artisan touch that makes each product unique.



## Venetian Smart Light Award 2021

“Un ripensamento della forma classica della sospensione multibraccio, riletta con linguaggio e materiali contemporanei di qualità, con reminiscenze del design degli anni Cinquanta. Interessante il contrasto con il fascio di luce diffuso e brillante all’estremità di ogni cono sospeso”

## Venetian Smart Light Award 2021

“A rethinking of the classical shape of the multi-arm suspension, reinterpreted with a contemporary language and quality materials, with reminiscences of the Fifties Design. The contrast with the diffuse and brilliant beam of light at the end of each suspended cone turns out interesting”.



Art 04708 ON





Art 04707 AN



Art 04704 ON



Art 04702 BB



Art 04702 ON





Art 04701 AN



Art 04703 NR



Art 04706 AN



Art 04705 BB



Art 04706 ON



## Configurabile

Iconic è stato pensato come elemento basilare che può essere inserito in molteplici soluzioni illuminotecniche. Oltre alle proposte presenti, si possono creare combinazioni su misura per disegnare il proprio ambiente Iconic.

## Configurable

Iconic was conceived as a basic element that can be inserted in multiple lighting solutions. In addition to the proposals in this catalog, you can create tailor-made combinations to design your own Iconic space.

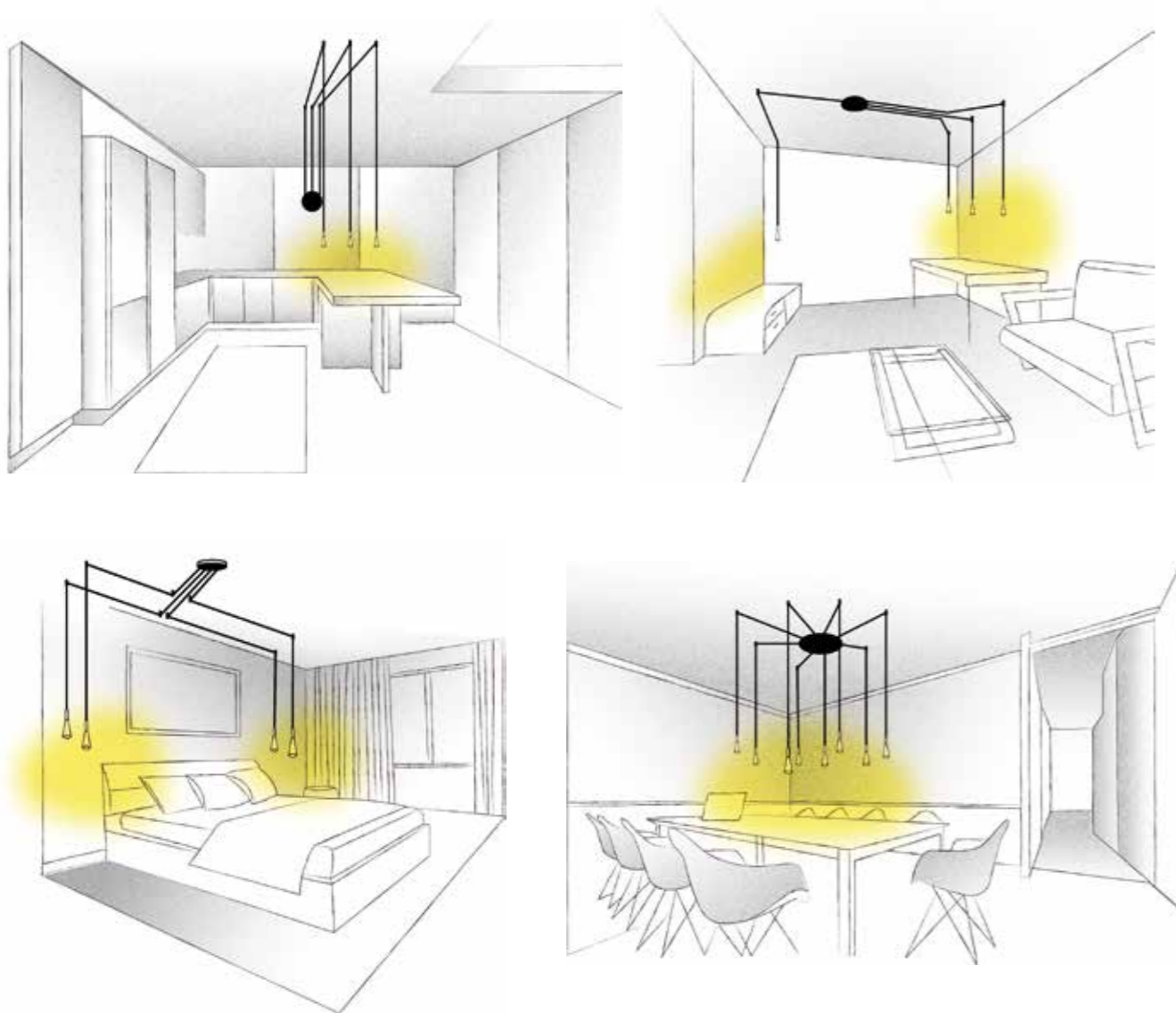

Per una soluzione personalizzata contatta il nostro ufficio tecnico.  
For a customized solution please contact our technical department.



04701

Suspension  
7 W  
1100 Lumen  
CRI90

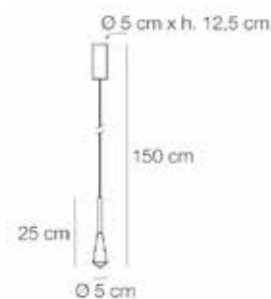

04702

Wall lamp  
7 W  
1100 Lumen  
CRI90

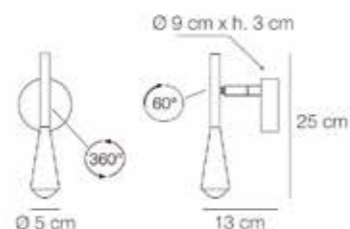

04703

Table lamp  
6 W  
850 Lumen  
CRI90

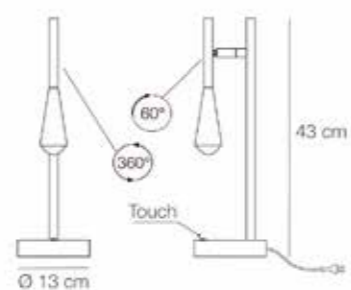

04704

Floor lamp  
2x6 W  
2x850 Lumen  
CRI90

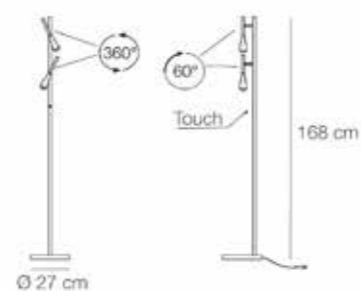

Structure	Dimmer	Led Light	Lens	IP	Diffuser
AN	D (Dimmer)	H 2700 K	X (No lens)	X (IP20)	XX
BB		W 3000 K	9 (90°)		
NR		N 4000 K			
ON					

04705

Suspension  
3x5 W  
3x650 Lumen  
CRI90  
On request: Dali - 0/10V



04706

Suspension  
5x6 W  
5x850 Lumen  
CRI90  
On request: Dali - 0/10V

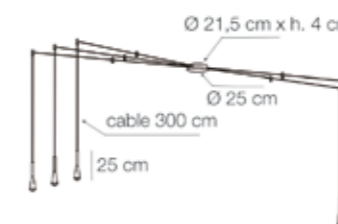

04707

Suspension  
6x6 W + 1x3 W  
6x850 + 1x400 Lumen  
CRI90  
On request: Dali - 0/10V



04708

Suspension  
8x6 W + 1x3 W  
8x850 + 1x400 Lumen  
CRI90  
On request: Dali - 0/10V

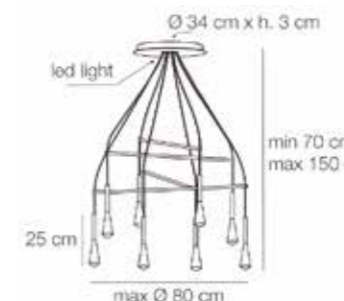

Structure	Dimmer	Led Light	Lens	IP	Diffuser
AN	D (Dimmer)	H 2700 K	X (No lens)	X (IP20)	XX
BB		W 3000 K	9 (90°)		
NR		N 4000 K			
ON					



*“Gli astri brillano nella notte come cerchi luminosi  
che rischiarano il buio”*

*La luce si sprigiona da forme circolari, evocando nella forma  
e nell'effetto luminoso l'immagine astrale notturna.*

Bianca / Gaia

*“The stars shine in the night like luminous circles  
that lighten the dark”*

*The light is released from circular shapes, evoking the nocturnal  
astral image in the shape and luminous effect.*



# Bianca

Designer: Simone Bellicini

“La contemporaneità del vetro soffiato”  
“The contemporaneity of glass blowing”



**DESIGN** Il motivo principale è il cerchio, piatto o con volume che diventa una sfera appiattita. Un gioco di contrasti che scaturisce dalla prospettiva e dal colore. La vista laterale mette in risalto il contrasto di volumi tra il metallo e il vetro, mentre la vista frontale esalta le finiture.



**PERSONALITÀ** Bianca può essere applique o plafoniera, singola o in gruppo. Le diverse finiture, scelte attentamente tra le palette più contemporanee, dialogano armoniosamente tra loro anche nei toni più audaci. L'alluminio riciclabile della struttura e il led integrato sostituibile la rendono una lampada sostenibile.



**MAESTRIA** Vetro bianco latte soffiato nel nostro territorio è il materiale scelto come diffusore di luce per Bianca. Oggi come nel Rinascimento si utilizza la stessa tecnica della soffiatura nello stampo, patrimonio della cultura storica e imprenditoriale del Veneto.

**DESIGN** The main subject is the circle, either flat or with volume that becomes a flattened sphere. A play of contrasts springing from the perspective and the colour. The side view highlights the contrasting volumes between metal and glass, the frontal view highlights the finishes instead.

**PERSONALITY** Bianca is available as wall lamp or ceiling one, single or a group. The several finishes, chosen carefully among the most contemporary palettes, talk to each-other harmoniously even in the boldest shades. The recycled aluminium of the structure and the replaceable built-in LED make the lamp sustainable.

**EXPERTISE** The milk-white blown glass from our territory is the material chosen as Bianca's light diffuser. Nowadays, as in Renaissance, the same mold-blown glass technique is used, since it is considered a historical, cultural and entrepreneurial heritage of Veneto.









Art 05602 OL

Art 05601 NG

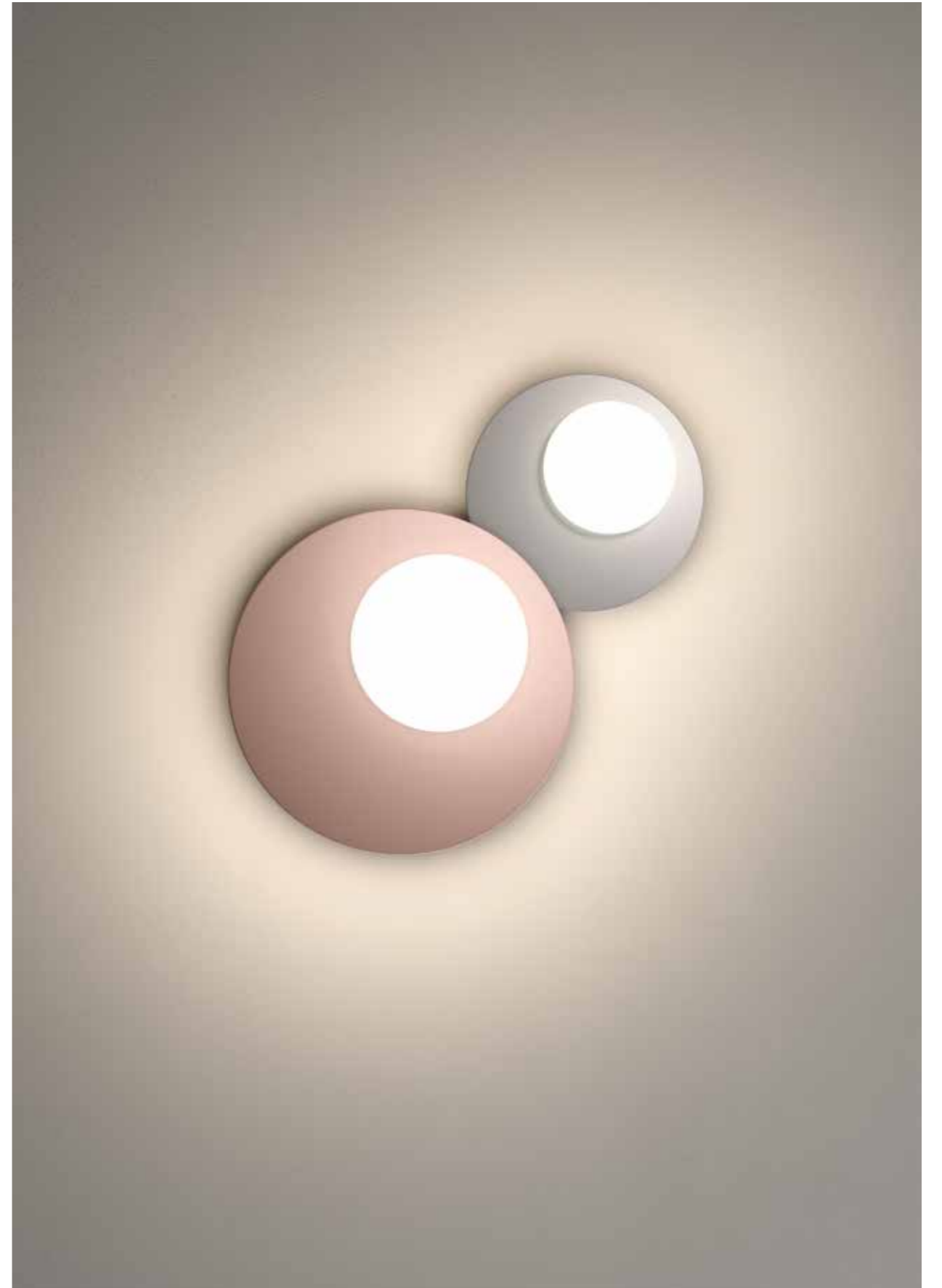

Art 05602 RF

Art 05601 LA





Art 05601 OL

**05601**

Ceiling / Wall lamp  
7 W  
1100 Lumen  
CRI90

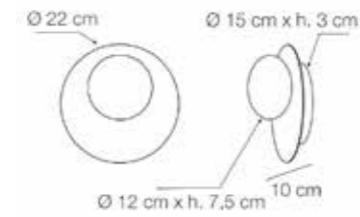

**05602**

Ceiling / Wall lamp  
12 W  
1700 Lumen  
CRI90

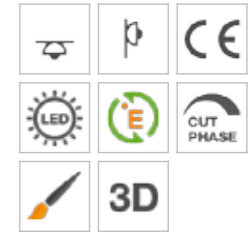
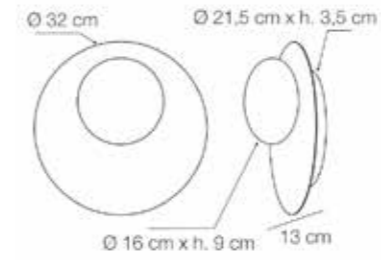

Structure	Dimmer	Led Light	Lens	IP	Diffuser
LA	<b>D</b> (Dimmer)	<b>H</b> 2700 K	<b>X</b> (No lens)	<b>X</b> (IP20)	BB <input type="checkbox"/>
NG		<b>W</b> 3000 K		<b>P</b> (IP44)	
NR		<b>N</b> 4000 K			
OL					
RF					



# Gaia

Designer: Alessandro Todesco

“Emozioni e sensazioni armoniche”  
“Harmony of emotions and sensations”



**DESIGN** Forma semplice arricchita dal gioco di pieni e di vuoti, Gaia dona all'ambiente piacevoli effetti luminosi che creano una atmosfera dinamica. Un gioco di luce che suscita emozioni e sensazioni armoniche.

**DESIGN** A simple shape enhanced by the interplay between solids and voids, Gaia creates interesting lighting effects and a dynamic atmosphere. A play of light that evokes a harmony of emotions and sensations.



**PERSONALITÀ** E' una lampada dalla vocazione Green: efficienza del led integrato, scelta di materiali riciclabili, lungo ciclo di vita. Leggera e resistente, il suo corpo è in alluminio. La luce viene plasmata attraverso i tagli laser 3D esaltandone la forma.

**PERSONALITY** A product with a green vocation: integrated LED efficiency, recyclable materials, long life cycle. Lightweight and strong, with aluminium body. The light is shaped by the 3D laser cuts, enhancing its form.



**MAESTRIA** La finitura bronzo è eseguita artigianalmente con 3 passaggi di colore per creare l'effetto bicolore con l'interno oro e l'esterno bronzo. La lavorazione bronzo è eseguita a mano, rendendo unica ogni lampada.

**EXPERTISE** The bronze finish is the result of 3 colour passes to create the two-colour effect with the gold interior and bronze exterior. This process is carried out by hand, making each product unique.











Art 04401 BZ (Version GU10 Art. 04431 BZ)



Art 04401 TN (Version GU10 Art 04431 TN)







Art 04406 TN



Art 04409 BB (Version GU10 Art 04439 BB)



**BZ - Bronzo** La finitura bronzo è eseguita artigianalmente con 3 passaggi di colore per creare l'effetto bicolore con l'interno oro e l'esterno bronzo.

**BZ - Bronze** The bronze finish is the result of 3 colour passes to create the two-colour effect with the gold interior and bronze exterior.



**TN - Titanio** Il colore Titatium è un grigio scuro con tonalità calda. Accesa la luce illumina l'interno della lampada creando un effetto bicolore.

**BZ - Titanium** The Titatium color is a dark gray with a warm hue. When turned on, the light illuminates the interior of the lamp, creating the two-colour effect.



**BB - Bianco** Il colore bianco trova la sua naturale esaltazione negli ambienti con le pareti colorate. Installata su pareti bianche la lampada si integra nell'ambiente, per evidenziare la sua personalità quando viene accesa.

**BB - White** The white color finds its natural exaltation in the rooms with colored walls. Installed on white walls, the lamp integrates into the surroundings, to highlight its personality when it is turned on.

**04401**

Suspension  
12 W  
1650 Lumen  
CRI90

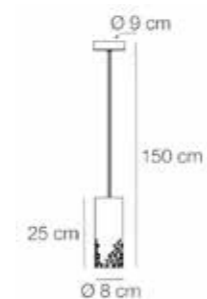

**04402**

Suspension  
12 W  
1650 Lumen  
CRI90

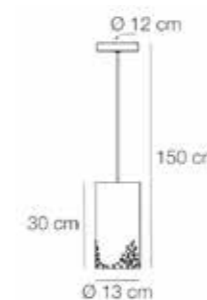

**04406**

Wall lamp  
2 x 12 W  
2 x 1650 Lumen  
CRI90

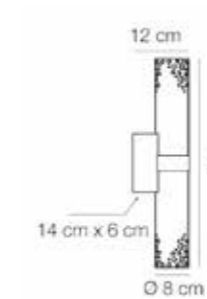

**04409**

Ceiling lamp  
6 W  
825 Lumen  
CRI90



Structure	Dimmer	Led Light	Lens	IP	Diffuser
BB	<b>D</b> (Dimmer)	<b>H</b> 2700 K	<b>X</b> (No lens)	<b>X</b> (IP20)	<b>XX</b>
BZ		<b>W</b> 3000 K			
TN		<b>N</b> 4000 K			





Art 04501 TN (Version G9 Art 04531 TN)



Art 04502 BZ (Version E14 Art 04532 BZ)



Art 04503 TN (Version E14 Art 04533 TN)





Art 04506 BZ (Version E14 Art 04536 BZ)



Art 04507 BZ (Version G9 Art 04537)





Art 04505 BZ (Version E14 Art 04535 BZ)



Art 04504 TN (Version G9 Art 04534 TN)



04501

Suspension  
24 W  
3500 Lumen  
CRI90  
On request: Dali - 0/10V

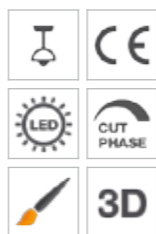
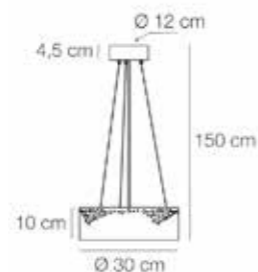

04502

Suspension  
42 W  
6100 Lumen  
CRI90  
On request: Dali - 0/10V



04503

Suspension  
59 W  
8800 Lumen  
CRI90  
On request: Dali - 0/10V

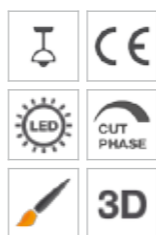
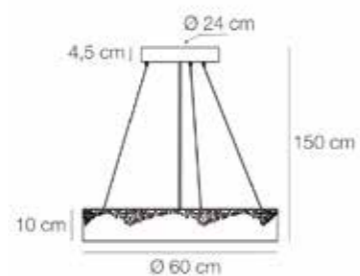

04507

Wall light  
17,2 W  
2450 Lumen  
CRI90

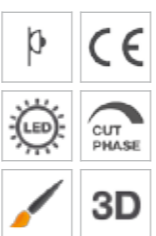
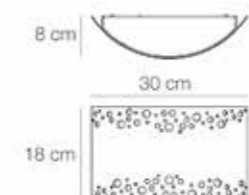

Structure	Dimmer	Led Light	Lens	IP	Diffuser
BZ	<b>D</b> (Dimmer)	<b>H</b> 2700 K	<b>X</b> (No lens)	<b>X</b> (IP20)	<b>XX</b>
TN		<b>W</b> 3000 K			
		<b>N</b> 4000 K			

04504

Ceiling lamp  
24 W  
3500 Lumen  
CRI90  
On request: Dali - 0/10V

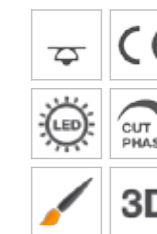

04505

Ceiling lamp  
42 W  
6100 Lumen  
CRI90  
On request: Dali - 0/10V

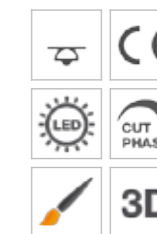
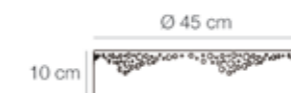

04506

Ceiling lamp  
59 W  
8800 Lumen  
CRI90  
On request: Dali - 0/10V

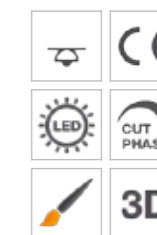

Structure	Dimmer	Led Light	Lens	IP	Diffuser
BZ	<b>D</b> (Dimmer)	<b>H</b> 2700 K	<b>X</b> (No lens)	<b>X</b> (IP20)	<b>XX</b>
TN		<b>W</b> 3000 K			
		<b>N</b> 4000 K			

**04431 (04401 Bulb version)**

Suspension Ø 8 cm  
GU10 1x max 7 W



**04432 (04402 Bulb version)**

Suspension Ø 13 cm  
E27 1x max 13 W



**04439 (04409 Bulb version)**

Ceiling Lamp Ø 8 cm  
GU10 1x max 7 W



Lampadina non inclusa / Bulb not included

Structure	Dimmer	Led Light	Lens	IP	Diffuser
BB	X (No planned)	X (No planned)	X (No planned)	X (IP20)	XX (No planned)
BZ					
TN					

**04531 (04501 Bulb version)**

Suspension Ø 30 cm  
G9 5x max 5 W



**04532 (04502 Bulb version)**

Suspension Ø 45 cm  
E14 6x max 5 W



**04533 (04503 Bulb version)**

Suspension Ø 60 cm  
E14 8x max 5 W



**04534 (04504 Bulb version)**

Ceiling Lamp Ø 30 cm  
G9 5x max 5 W



**04535 (04505 Bulb version)**

Ceiling Lamp Ø 45 cm  
E14 6x max 5 W



**04536 (04506 Bulb version)**

Ceiling Lamp Ø 60 cm  
E14 8x max 5 W



**04537 (04507 Bulb version)**

Wall lamp  
G9 4x max 5 W



Lampadina non inclusa / Bulb not included

Structure	Dimmer	Led Light	Lens	IP	Diffuser
BZ	X (No planned)	X (No planned)	X (No planned)	X (IP20)	XX (No planned)
TN					



*“Le superfici hanno la capacità di trasformarsi in riflettori donando un’atmosfera avvolgente e magica.”*

*La luce riflessa non illumina l’ambiente direttamente, ma attraverso rimbalzi su una o più superfici. E’ una questione di fisica, che fa vibrare le corde delle emozioni.*

LikeQ / Plettro / Rondaj

*“Surfaces have the ability to change into spotlights giving a welcoming and magical atmosphere.”*

*The reflected light does not light the room directly, but by bouncing off one or more surfaces. It is a matter of physics, that makes our emotional strings vibrate.*



# Like Q

Designer: Maurizio Betteto

“Proprio Come te”  
“Just Like You”



**DESIGN** Forma semplice, senza spigoli, costruita con materiali nobili ma utilizzati in modo sobrio, e quel pizzico di sale per darci il giusto sapore: la dinamicità. Il movimento che consente di creare diversi effetti di luce, atmosfere che cambiano con un semplice tocco della mano.



**PERSONALITÀ** Le diverse combinazioni di colore conferiscono a Like Q una grande capacità di adattarsi ai diversi stili di arredamento. Il diffusore in vetro riflette la luce in modo morbido e avvolgente. L'alluminio riciclabile e il led integrato con LED-change system rendono Like Q una lampada rispettosa dell'ambiente.



**MAESTRIA** Il vetro, che rimanda alla tradizione del territorio, è utilizzato come superficie riflettente perché diffonde la luce in modo omogeneo e morbido. La finitura in foglia oro sul vetro è eseguita a mano, donando a Like Q l'unicità e la ricercatezza del «fatto a mano».

**DESIGN** Essential shape, rounded corners, noble materials used simply and elegantly. The structure can be moved by a simple touch of the hand, creating different lighting effects and atmospheres, and adding a dynamic flavour.

**PERSONALITY** The different colour combinations give Like Q great scope for adapting to different furnishing styles. The glass reflector creates a soft suffused ambience. The recyclable aluminium and the integrated LED with green design system make Like Q an environment-friendly product.

**EXPERTISE** The glass, a reminder of local tradition, is used as a reflecting surface diffusing the light softly and uniformly. The gold leaf finish on the glass is hand-done, giving Like Q the uniqueness and refined elegance typical of a handmade product.







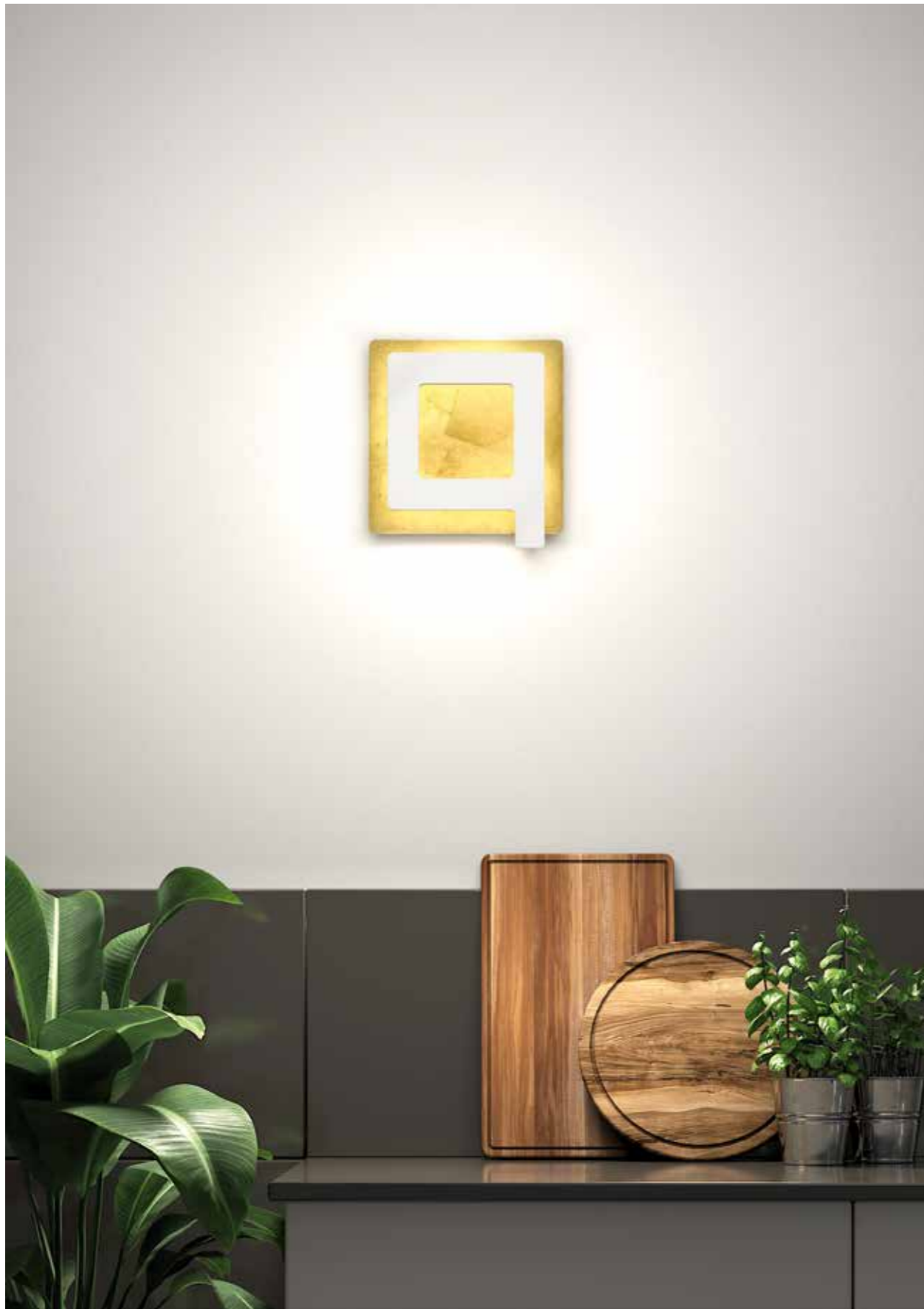

Art 04602 BB\_FO



Art 04602 NR\_FO





Art 04603 AS\_BB



Art 04604 AS\_BB



Art 04607 OS\_BB



Art 04608 OS\_BB



04601

Wall lamp  
16,5 W  
2300 Lumen  
CRI90

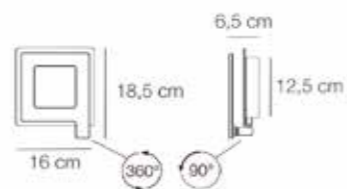

04602

Wall lamp  
25 W  
3650 Lumen  
CRI90

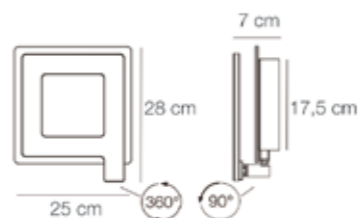

04603

Ceiling lamp  
16,5 W  
2300 Lumen  
CRI90

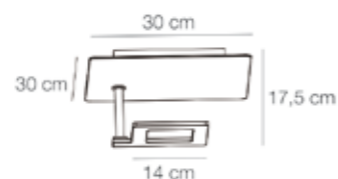

04604

Ceiling lamp  
25 W  
3650 Lumen  
CRI90

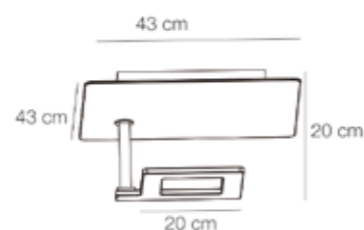

Structure	Dimmer	Led Light	Lens	IP	Diffuser
AS	<b>D</b> (Dimmer)	<b>H</b> 2700 K	<b>X</b> (No lens)	<b>X</b> (IP20)	BB
BB		<b>W</b> 3000 K			FO
NR		<b>N</b> 4000 K			
OS					
TN					

04607

Ceiling lamp  
33 W  
4600 Lumen  
CRI90

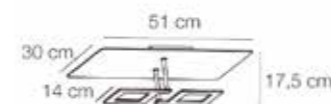

04608

Ceiling lamp  
50 W  
7300 Lumen  
CRI90

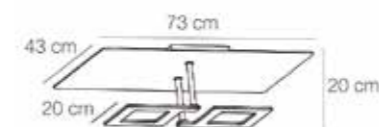

Structure	Dimmer	Led Light	Lens	IP	Diffuser
AS	<b>D</b> (Dimmer)	<b>H</b> 2700 K	<b>X</b> (No lens)	<b>X</b> (IP20)	BB
BB		<b>W</b> 3000 K			FO
NR		<b>N</b> 4000 K			
OS					
TN					



Art 04610 ON

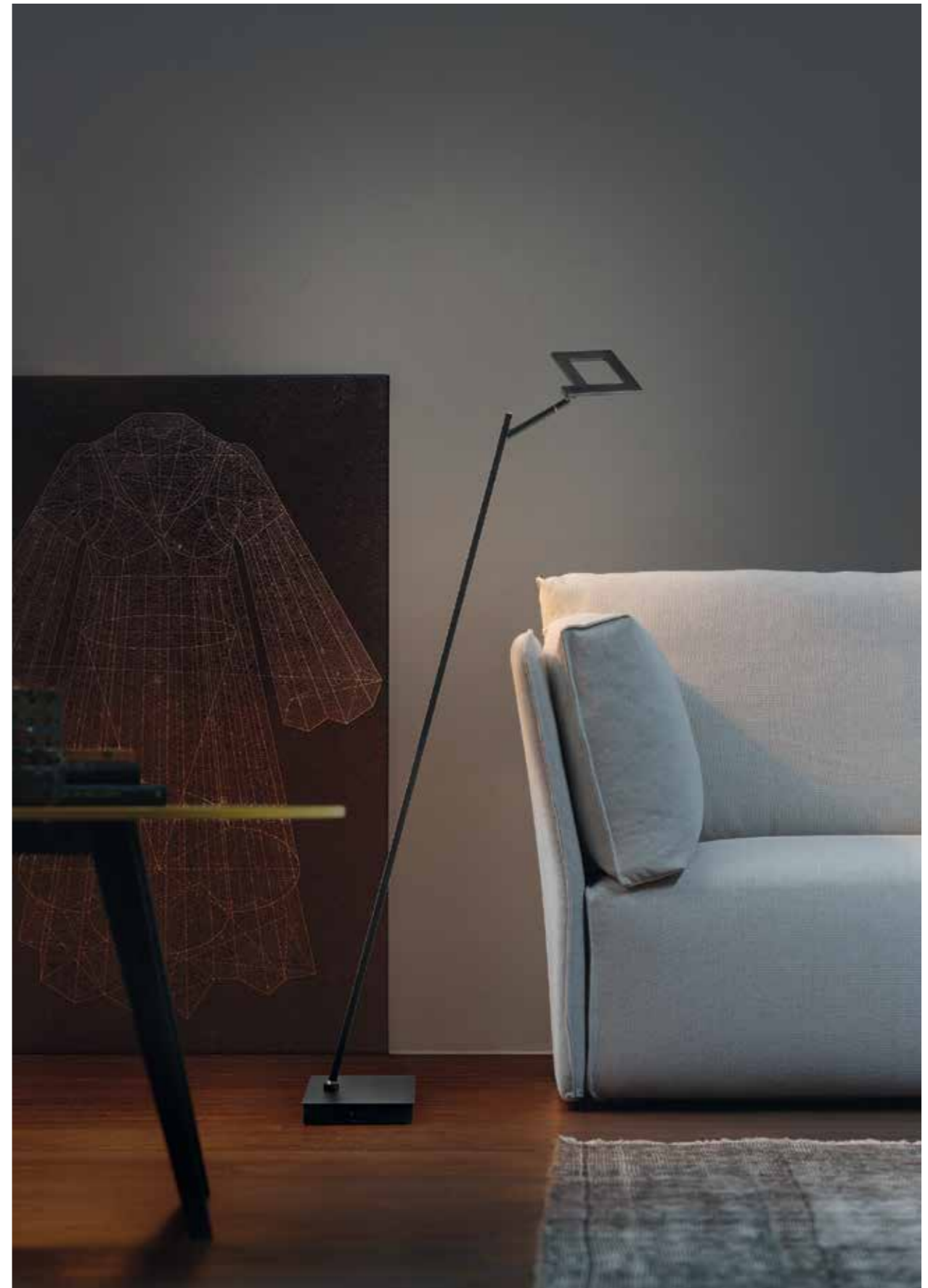

Art 04611 NR



04610

Floor lamp  
2x25 W  
2x3700 Lumen  
CRI90  
On request: Tunable White



04611

Floor lamp  
16,5 W  
2300 Lumen  
CRI90



Structure	Dimmer	Led Light	Lens	IP	Diffuser
AN	T (Touch)	H 2700 K	X (No lens)	X (IP20)	XX
NR		W 3000 K			
ON		N 4000 K			

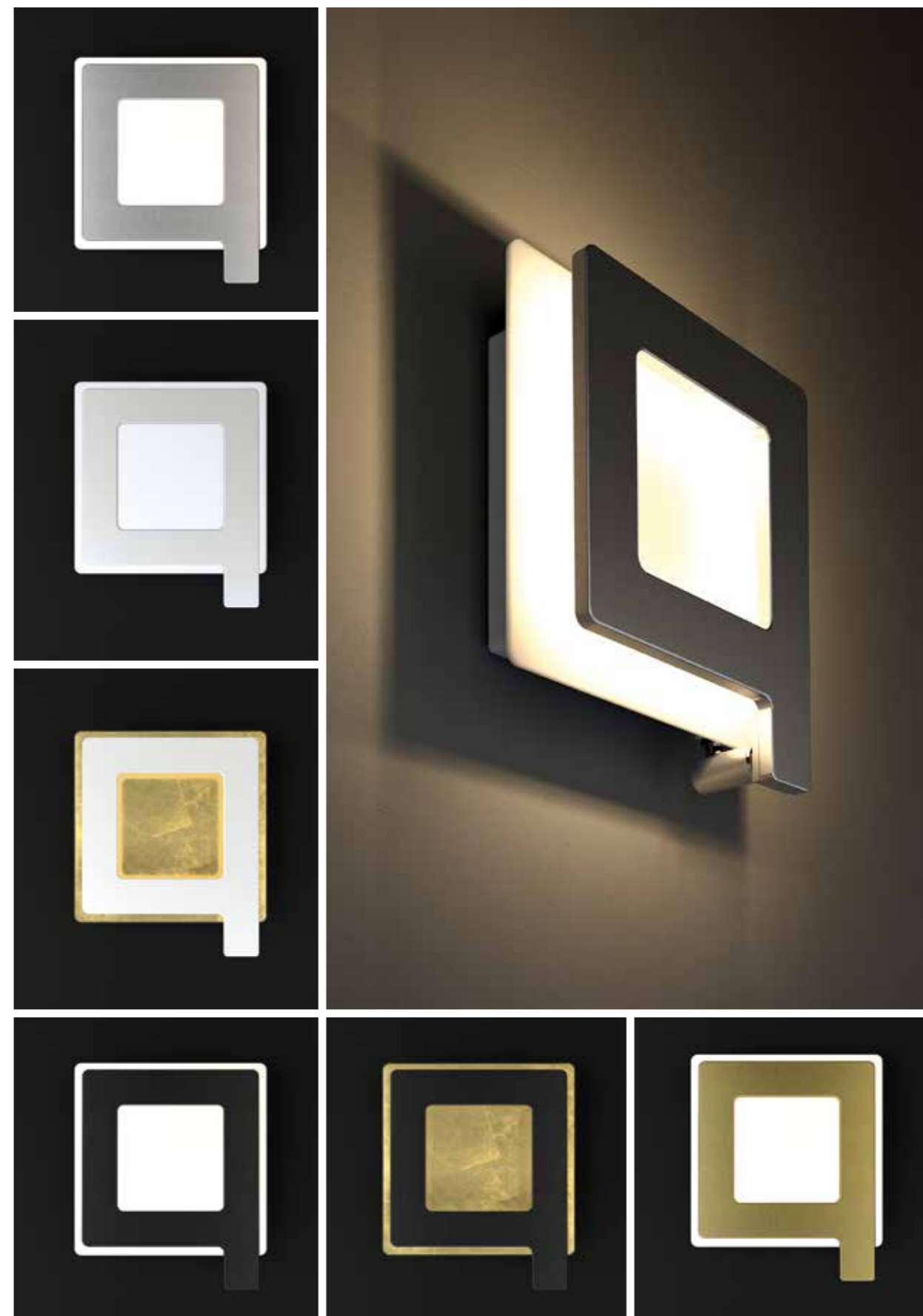

# Plettro

Designer: Elesi Creative Lab

“Armonia di luce e spazialità”  
“Harmony of light and spatiality”



**DESIGN** La musica spesso aiuta il pensiero a vagare libero, così da trasformare in una collezione di lampade un oggetto che dialoga per accordi: il plettro. Una forma arrotondata ed equilibrata, si inserisce armoniosamente dell'ambiente.

**DESIGN** Music often helps thoughts to roam free, so as to transform an object talking by chords, the plectrum, into a lamp collection. A rounded and well-balanced shape fitting harmoniously into the surrounding environment.



**PERSONALITÀ** La luce si riflette sul vetro satinato, illuminando l'ambiente in modo omogeneo e avvolgente. Una linea minimale, con la sua luce diffusa esalta i soffitti e la profondità dello spazio. Il led integrato è progettato con Led Change System.

**PERSONALITY** The light reflects on the satin glass, lighting the room homogeneously and an embracing way. A minimal line enhancing ceilings and the depth of the spaces through its diffuse light. The built-in LED has been designed by the LED Change system.



**MAESTRIA** Il vetro, che rimanda alla tradizione del territorio, è utilizzato come superficie riflettente che consente la diffusione della luce in modo omogeneo e morbido.

**EXPERTISE** The glass, recalling the tradition of our territory, is used as a reflective surface enabling the light diffusion homogeneously and in a soft way.









Art 05503 LA



Art 05504 NR



Art 05505 OL



Art 05502 OL

05501

Ceiling lamp  
21 W  
2850 Lumen  
CRI90



05502

Ceiling lamp  
40 W  
5700 Lumen  
CRI90

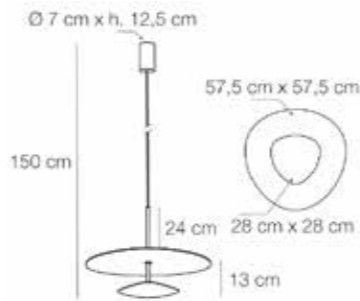

05503

Ceiling lamp  
21 W  
2850 Lumen  
CRI90

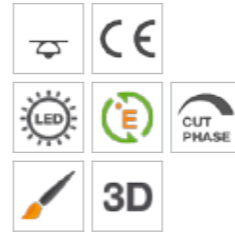
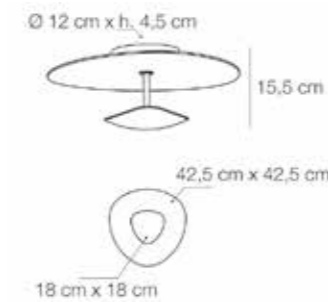

05504

Ceiling lamp  
40 W  
5700 Lumen  
CRI90

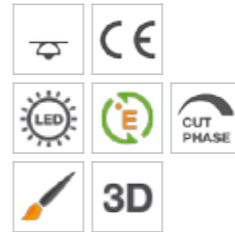
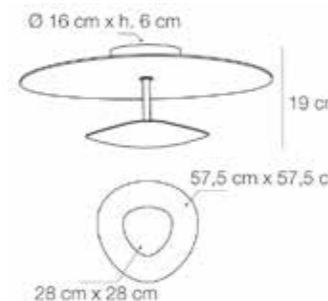

Structure	Dimmer	Led Light	Lens	IP	Diffuser
BE	<b>D</b> (Dimmer)	<b>H</b> 2700 K	<b>X</b> (No lens)	<b>X</b> (IP20)	BB <input type="checkbox"/>
LA		<b>W</b> 3000 K			
NR		<b>N</b> 4000 K			
OL					

05505

Wall lamp  
12 W  
1700 Lumen  
CRI90

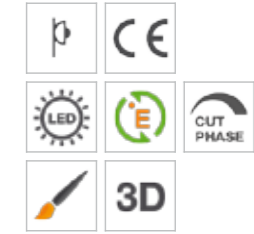
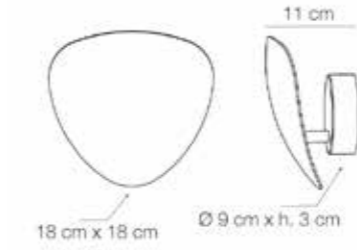

Structure	Dimmer	Led Light	Lens	IP	Diffuser
BE	<b>D</b> (Dimmer)	<b>H</b> 2700 K	<b>X</b> (No lens)	<b>X</b> (IP20)	<b>XX</b>
LA		<b>W</b> 3000 K			
NR		<b>N</b> 4000 K			
OL					



# Rondaj

Designer: Elesi Creative Lab

“L’essenza della luce indiretta.”  
“*The essence of indirect light*”



**DESIGN** «Rondaj» è un termine in esperanto che significa «rotondo», una forma semplice che racchiude un’illuminazione a led integrati ad alta efficienza. La lampada da terra illumina con luce riflessa, verso l’alto, e diretta, verso il basso, regolate separatamente da memory touch dimmer posti sul fusto.



**PERSONALITÀ** La luce diffusa è adatta per esaltare i soffitti e la profondità dello spazio. Attenta al comfort visivo, la lampada da terra è ideale per i momenti di relax.



**MAESTRIA** La cura nel dettaglio si esprime nelle finiture acciaio e oro francese attraverso la spazzolatura del metallo eseguita completamente a mano. Quell’artigianalità che conferisce unicità a ciascuna lampada.

**DESIGN** «Rondaj» is an Esperanto term meaning «round», a simple shape that encloses a high efficiency integrated LED lighting element. The floor lamp version illuminates upwards by reflected light and downwards by direct light, adjusted separately by memory touch dimmers located on the stem.

**PERSONALITY** Diffuse light enhances the ceiling and creates spatial depth. The floor lamp is designed with visual comfort in mind, and is ideal for moments of relaxation.

**EXPERTISE** Attention to detail can be seen in the steel and French gold finishes, with the metal brushing done 100% by hand. An artisan touch that makes each lamp unique.

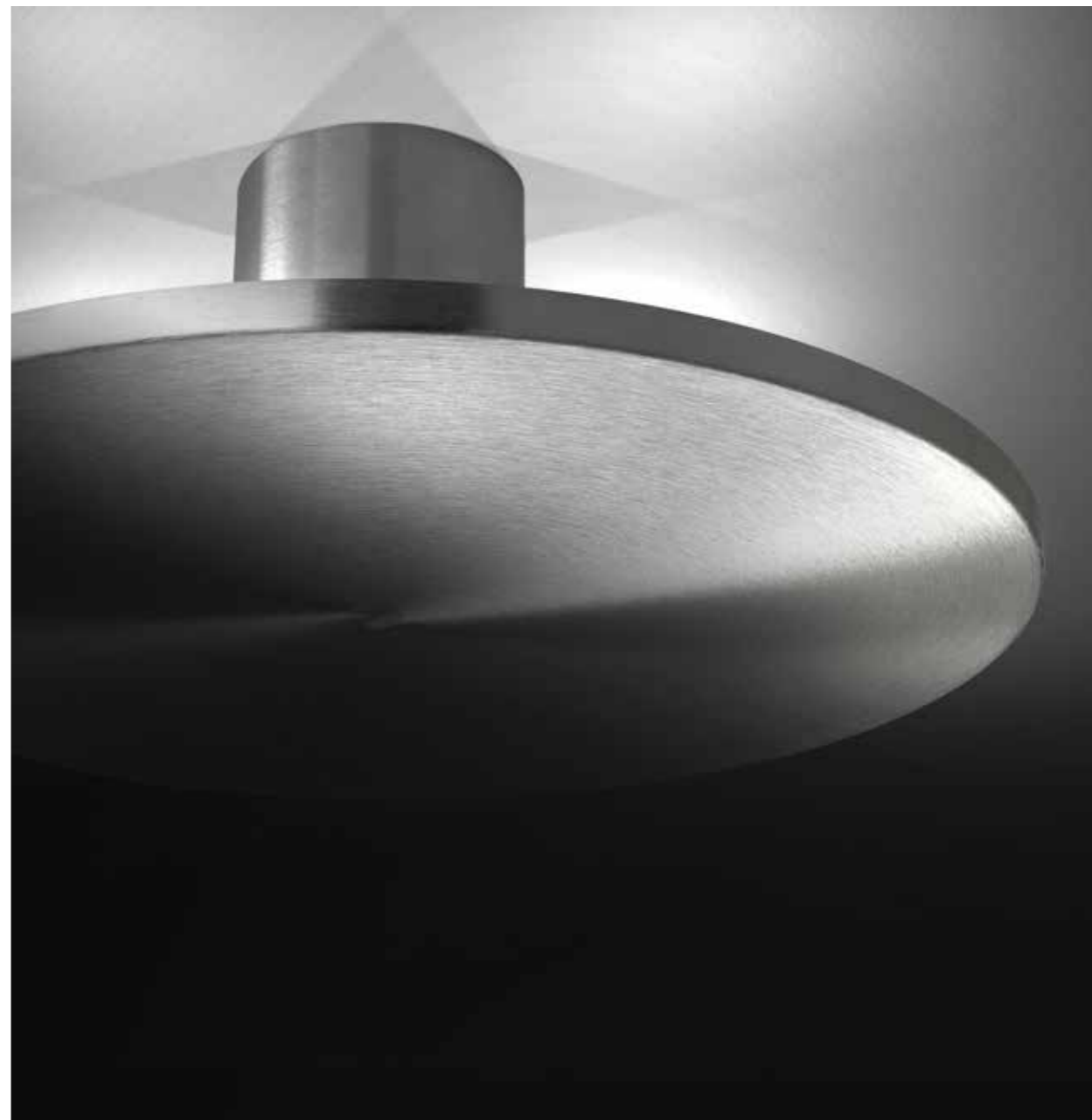



Art 03602 BB

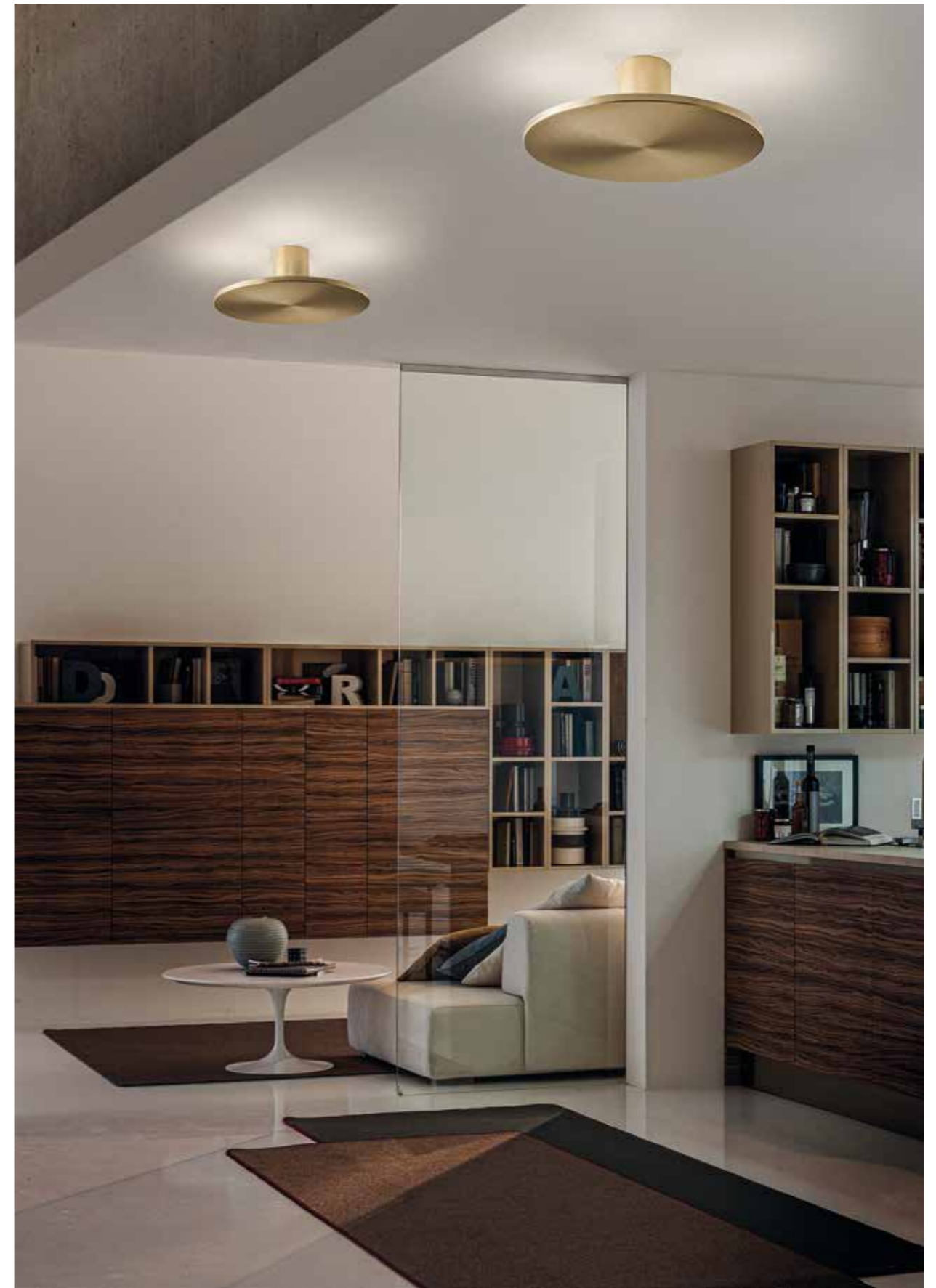

Art 03603 OF



Art 03605 OF



Art 03605 AC



03602

Ceiling lamp  
38 W  
5100 Lumen  
CRI90

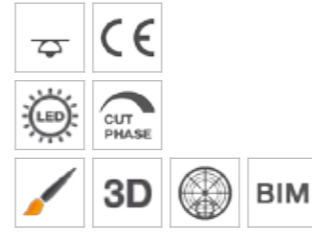
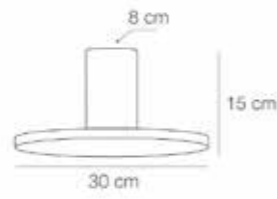

03603

Ceiling lamp  
50 W  
6800 Lumen  
CRI90

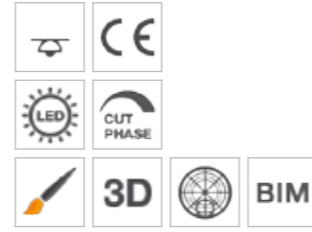
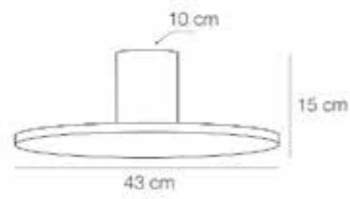

03605

Floor lamp  
38 up - 6 down W  
5100 up - 880 down Lumen  
CRI90



Structure	Dimmer	Led Light	Lens	IP	Diffuser
AC	D (Dimmer)	H 2700 K	X (No lens)	X (IP20)	XX
BB		W 3000 K			
OF		N 4000 K			



*“Lineare ed essenziale eppure  
così sorprendente”*

*Materiali, colori e forme diverse, accomunati dalla semplicità delle linee  
e dalla compattezza dei volumi. Puntiamo all'essenziale per dare valore.*

*Quid / Air / Pois / Mir / Aura*



*“Linear and minimalist  
and yet so amazing”*

*Materials, colours and different shapes, united by the simplicity  
of the lines and the volume compactness.  
We strongly believe in what is essential to add value.*



# Quid

Designer: Maurizio Betteto

“Lineare e funzionale”  
“*Linear and functional*”



**DESIGN** In omaggio ad un rigore stilistico dato dalle forme sobrie del design contemporaneo è nata Quid, una collezione di lampade dalle linee squadrate ed essenziali.

**DESIGN** *Quid, a collection of lights with square clean-cut lines, is a tribute to the rigorous style created by the essential forms typical of modern design.*



**PERSONALITÀ** Volumi compatti per una illuminazione funzionale, con luce diretta e indiretta. Le due parti in alluminio sono separate da un elemento in plexiglass (PMMA) che si illumina intorno al perimetro, donando ulteriore leggerezza alla sua forma.

**PERSONALITY** *Compact volumes for functional lighting, with direct and indirect light. The two aluminium parts are separated by a Plexiglas (PMMA) element that lights up around the perimeter, adding to the soft delicate effect of the design.*



**MAESTRIA** La finitura in foglia oro è eseguita a mano su tutte le parti metalliche, donando a Quid l'unicità e la ricercatezza del «fatto a mano».

**EXPERTISE** *The gold leaf finish is hand-done on all the metal parts, giving Quid the uniqueness and refined elegance typical of a handmade product.*







Art 02806 FO



Art 02807 NR



Art 02809 BB



Art 02810 BB



Art 02810 FO





Art 02818 BB

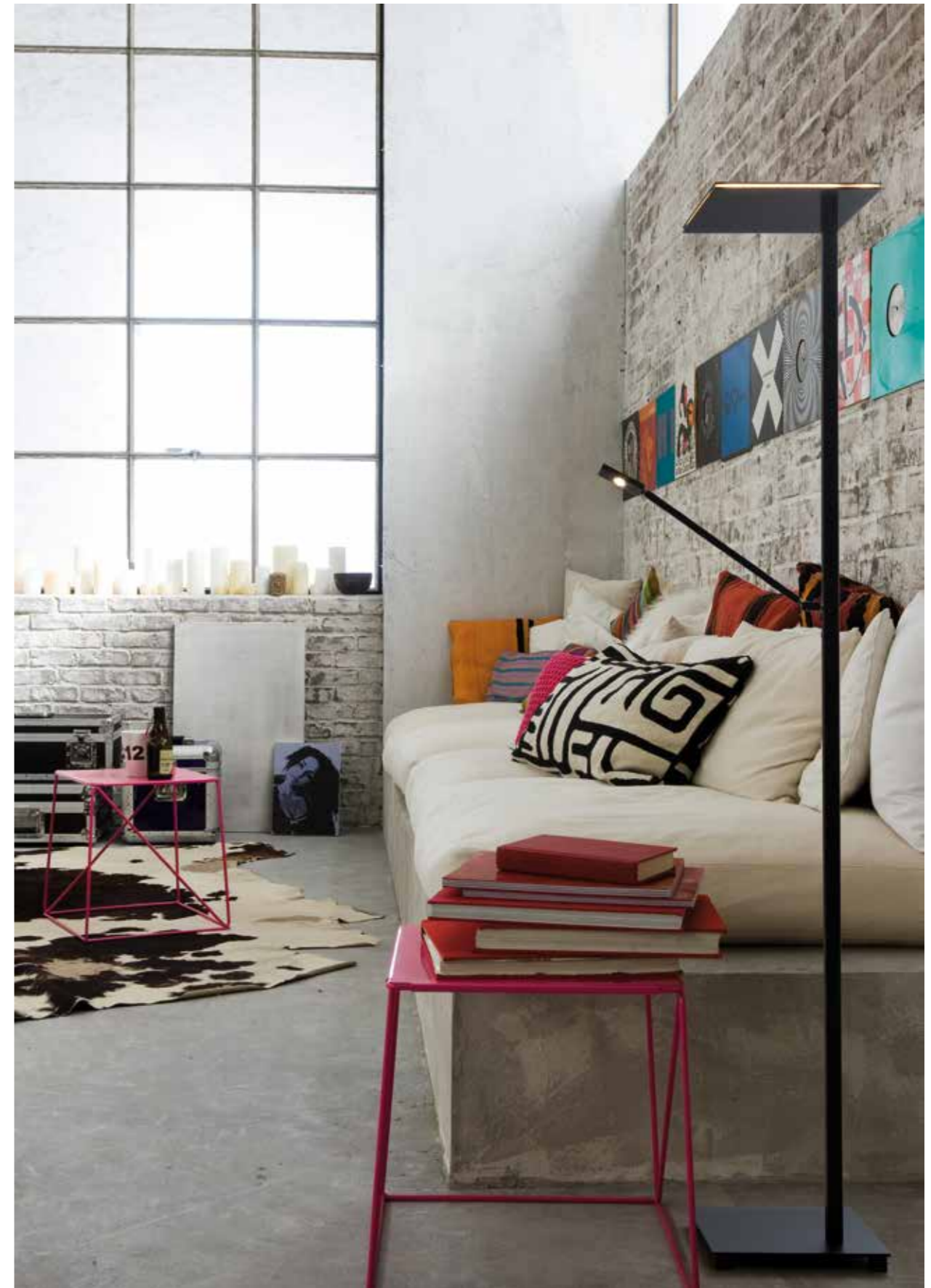

Art 02819 NR



02806

Suspension  
 22 up - 22 down W  
 3250 up-3250 down Lumen  
 CRI90  
 On request: Dali - 0/10V



02807

Suspension  
 34 up - 34 down W  
 4900 up-4900 down Lumen  
 CRI90  
 On request: Dali - 0/10V

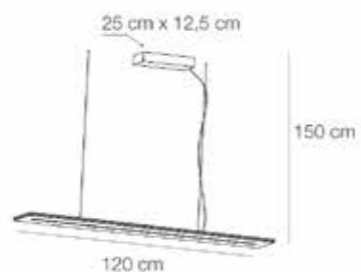

02809

Wall lamp  
 4,8 up - 1,6 down W  
 680 up - 220 down Lumen  
 CRI90

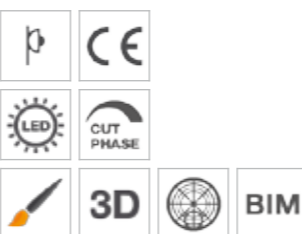
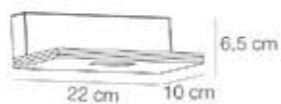

02810

Wall lamp  
 9,7 up - 3,2 down W  
 1360 up - 440 down Lumen  
 CRI90

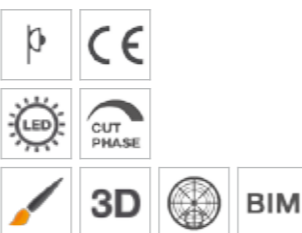
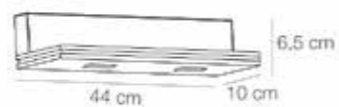

Structure	Dimmer	Led Light	Lens	IP	Diffuser
BB	<b>D</b> (Dimmer)	<b>H</b> 2700 K	<b>X</b> (No lens)	<b>X</b> (IP20)	<b>XX</b>
FO		<b>W</b> 3000 K			
NR		<b>N</b> 4000 K			

02818

Floor lamp  
 37,9 up - 3,2 down W  
 5100 up - 450 down Lumen  
 CRI90

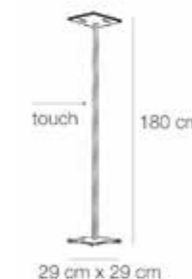

02819

Floor lamp  
 37,9 up + 4,5 down W  
 5100 up+640 down Lumen  
 CRI90

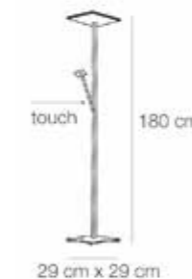

Structure	Dimmer	Led Light	Lens	IP	Diffuser
BB	<b>T</b> (Touch)	<b>H</b> 2700 K	<b>X</b> (No lens)	<b>X</b> (IP20)	<b>XX</b>
NR		<b>W</b> 3000 K			
		<b>N</b> 4000 K			

# Air

Designer: Maurizio Betteto

“Una poesia scritta nell’aria.”  
“A poem written in the air.”



**DESIGN** Ricerca dei materiali e volontà di esaltare la bellezza della luce. È questo che ha portato alla creazione di questa collezione di grande effetto e luminosità. Il design ha un’anima di metallo e la struttura in plexiglass (PMMA) con lavorazione di micro-puntinatura che permette una maggiore diffusione della luce.



**PERSONALITÀ** Leggerezza, essenzialità nelle forme e accurato accostamento dei materiali. Una silenziosa presenza che accesa rivela la sua personalità e vivacità. Le due tipologie di luce led (diffusa e direzionale), in combinazione consentono una illuminazione omogenea dello spazio.



**MAESTRIA** Per perfezionare la luminosità del materiale PMMA ogni pezzo viene lucidato a mano, mentre il bordo viene satinato per avere lungo il perimetro un effetto morbido di luce.

**DESIGN** The quest for refined materials and the desire to enhance the beauty of light. These are the two elements underlying this collection which creates an effect of great luminosity. The design has a metal core and Plexiglas (PMMA) structure with stippled pattern for greater light diffusion.

**PERSONALITY** Lightness, simple shapes and careful combination of materials. A silent presence that reveals a lively personality when switched on. The two types of LED light (diffuse and directional) combine to create a uniform lighting effect.

**EXPERTISE** To perfect the luminosity of the PMMA material, each piece is hand-polished, and the edge is satin-finished for a soft light effect around the perimeter.

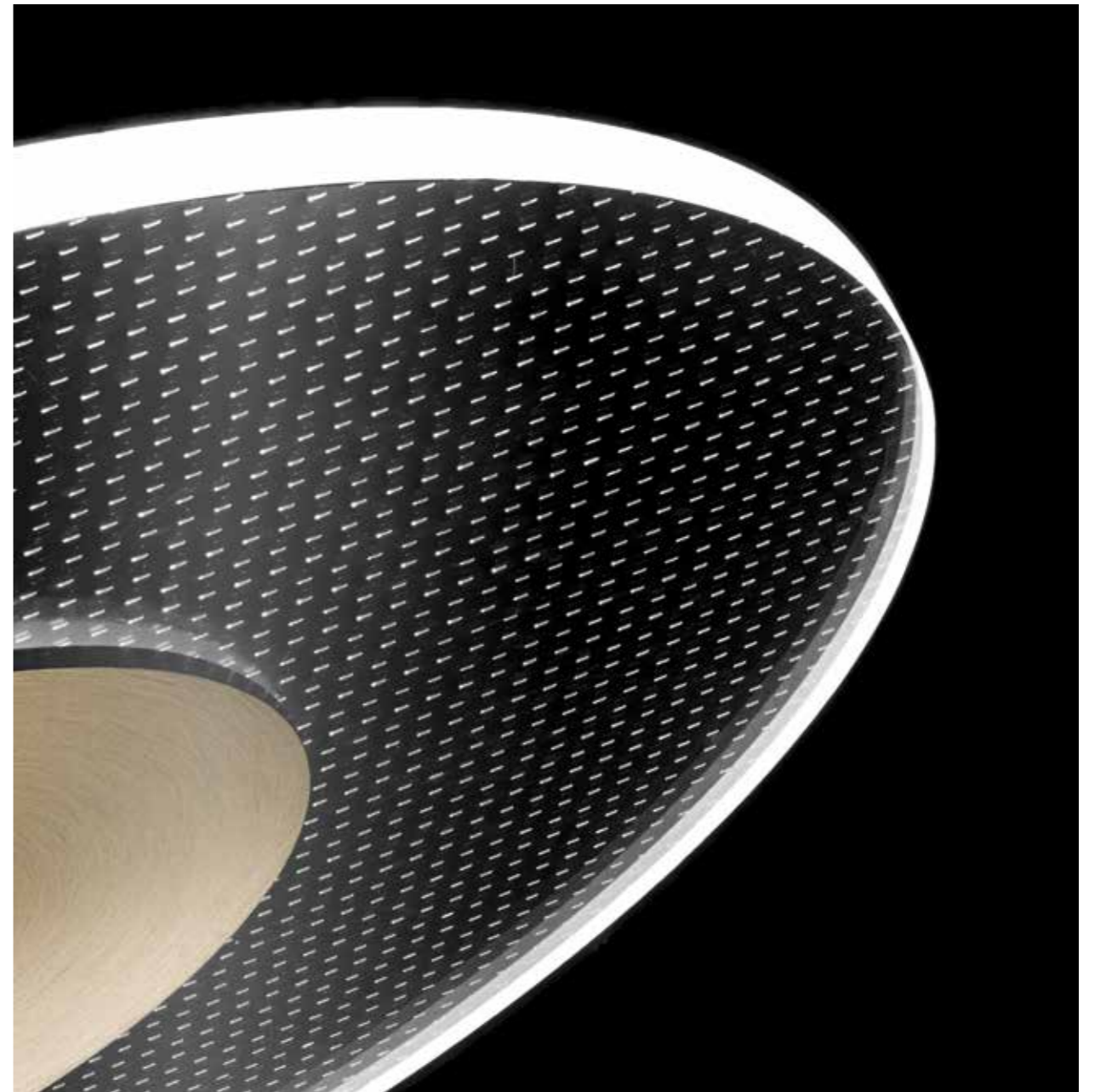



Art 03410 AC





Art 03409 AC

Art 03431 OS



Art 03410 OS

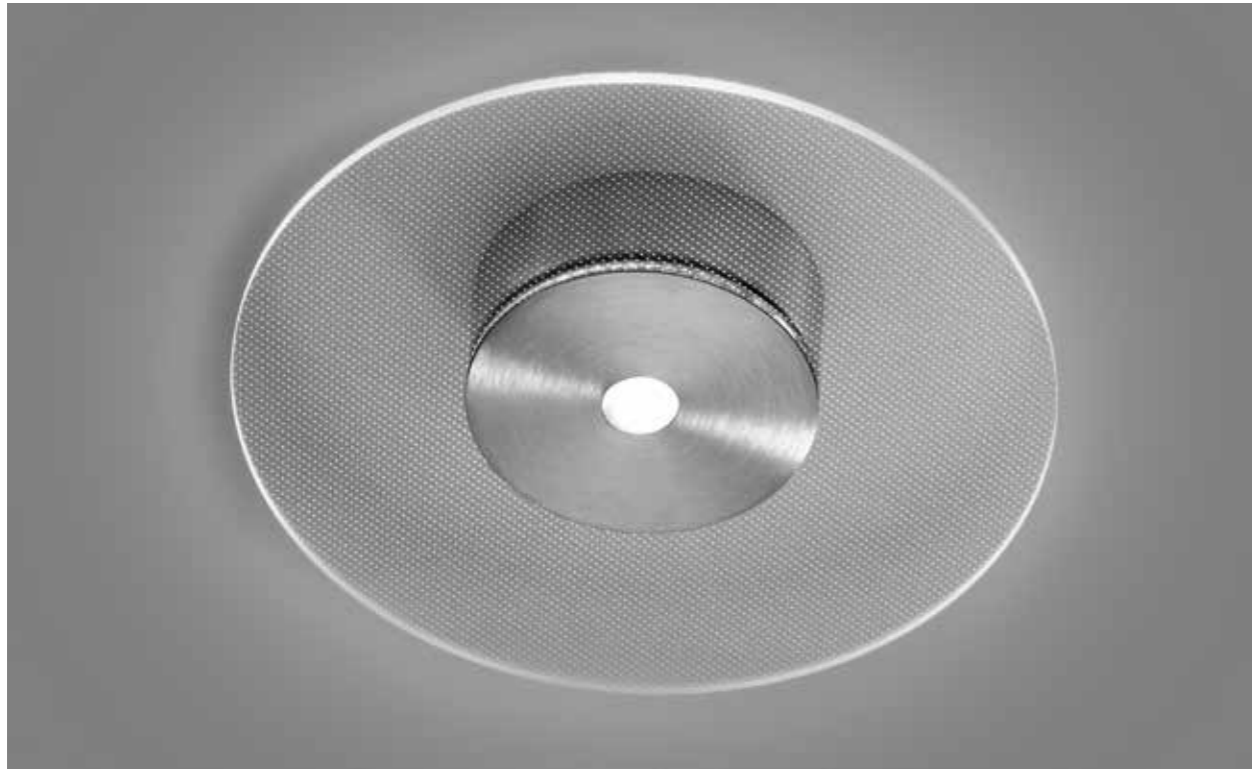

Art 03406 AC



Art 03433 AC



Art 03407 OS

03431

Suspension  
6,5 W  
850 Lumen  
CRI90

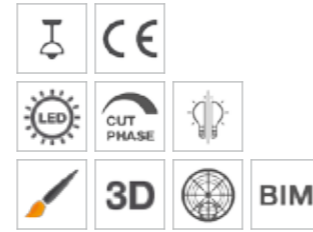

03409

Suspension  
9,8 W  
1500 Lumen  
CRI90

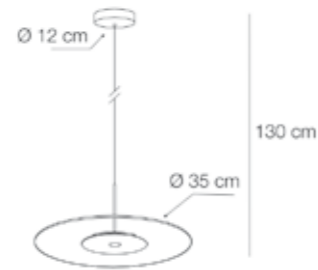

03410

Suspension  
17,3 W  
2500 Lumen  
CRI90

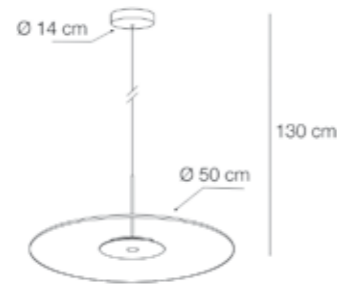

Structure	Dimmer	Led Light	Lens	IP	Diffuser
AC	D (Dimmer)	H 2700 K	X (No lens)	X (IP20)	XX
BB		W 3000 K			
OS		N 4000 K			

03433

Ceiling lamp  
6,5 W  
850 Lumen  
CRI90

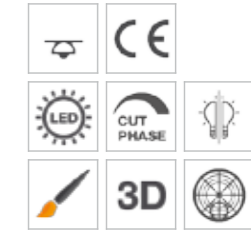
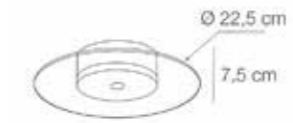

03406

Ceiling lamp  
9,8 W  
1500 Lumen  
CRI90

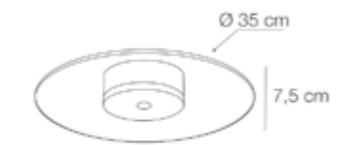

03407

Ceiling lamp  
17,3 W  
2500 Lumen  
CRI90

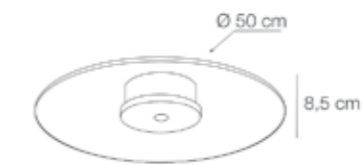

Structure	Dimmer	Led Light	Lens	IP	Diffuser
AC	D (Dimmer)	H 2700 K	X (No lens)	X (IP20)	XX
BB		W 3000 K			
OS		N 4000 K			





Art 03404 OS

Art 03403 OS / Art 03432 AC



Art 03401 BB

**03401**

Ceiling / Wall lamp  
1,5 W  
220 Lumen  
CRI90  
No Dimmer

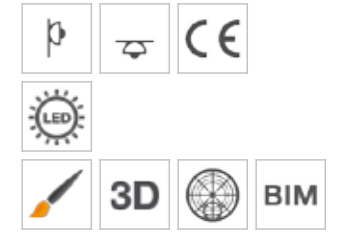

**03432**

Ceiling / Wall lamp  
2,4 W  
370 Lumen  
CRI90

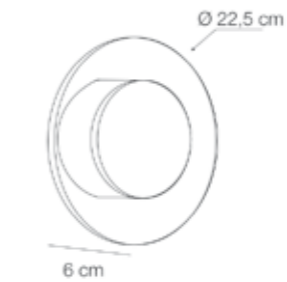

**03403**

Ceiling / Wall lamp  
3,9 W  
590 Lumen  
CRI90



**03404**

Ceiling / Wall lamp  
5,3 W  
810 Lumen  
CRI90

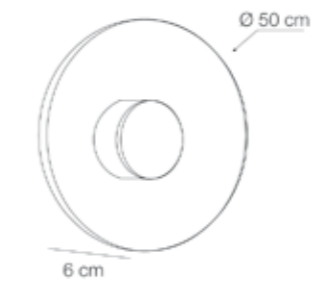

Structure	Dimmer	Led Light	Lens	IP	Diffuser
AC	<b>X</b> (No Dimmer)	<b>H</b> 2700 K	<b>X</b> (No lens)	<b>X</b> (IP20)	<b>XX</b>
BB	<b>D</b> (Dimmer)	<b>W</b> 3000 K			
OS		<b>N</b> 4000 K			

# Pois

Designer: Elesi Creative Lab

“Parabole di grande magnetismo”  
“Magnetic appeal”



**DESIGN** Nella collezione Pois il design sobrio delle forme e l'innovazione tecnologica si uniscono in un risultato vincente: un'unica lastra di vetro piano con abbassamenti eseguiti a caldo e un sistema di fissaggio magnetico, veloce, semplice e senza viti a vista.



**PERSONALITÀ** La forma geometrica della lampada è addolcita dai bassorilievi eseguiti in fusione a caldo del vetro. Essenziale, ma accattivante, possiede forte personalità grazie a questi dettagli che la rendono unica.



**MAESTRIA** Il vetro, che rimanda alla tradizione del territorio, può essere decorato in foglia oro, lavorazione artigianale che dona a Pois l'unicità e la ricercatezza del «fatto a mano».

**DESIGN** In the Pois collection, simple shapes and technological innovation combine for a winning result: one single sheet of flat glass, with hot-pressed indentations, and a simple quick magnetic fastening system, with no visible screws.

**PERSONALITY** The geometric shape of the light is softened by the hot-pressed indentations of the glass. Simple but eye-catching, it has a strong personality thanks to these details that make it unique.

**EXPERTISE** The glass, a reminder of local tradition, can be decorated in gold leaf, an artisan technique that gives Pois the uniqueness and refined elegance of a handmade product.



Nel 2019 POIS è stata insignita del VSL Award con le seguenti motivazioni: la lampada unisce la tradizione della lavorazione del vetro e una funzionalità non gratuita di linee stilizzate e pure. Leggerezza ed equilibrio declinati in un materiale prezioso, con parabole di grande magnetismo e armonia.

In 2019 POIS received the VSL Award for the following reasons: the light combines glass working tradition with the wholly appropriate functionality of pure stylized lines. Lightness and equilibrium expressed in a precious material, with effects of great magnetism and harmony.





Art 02001 BB



Art 02002 NR

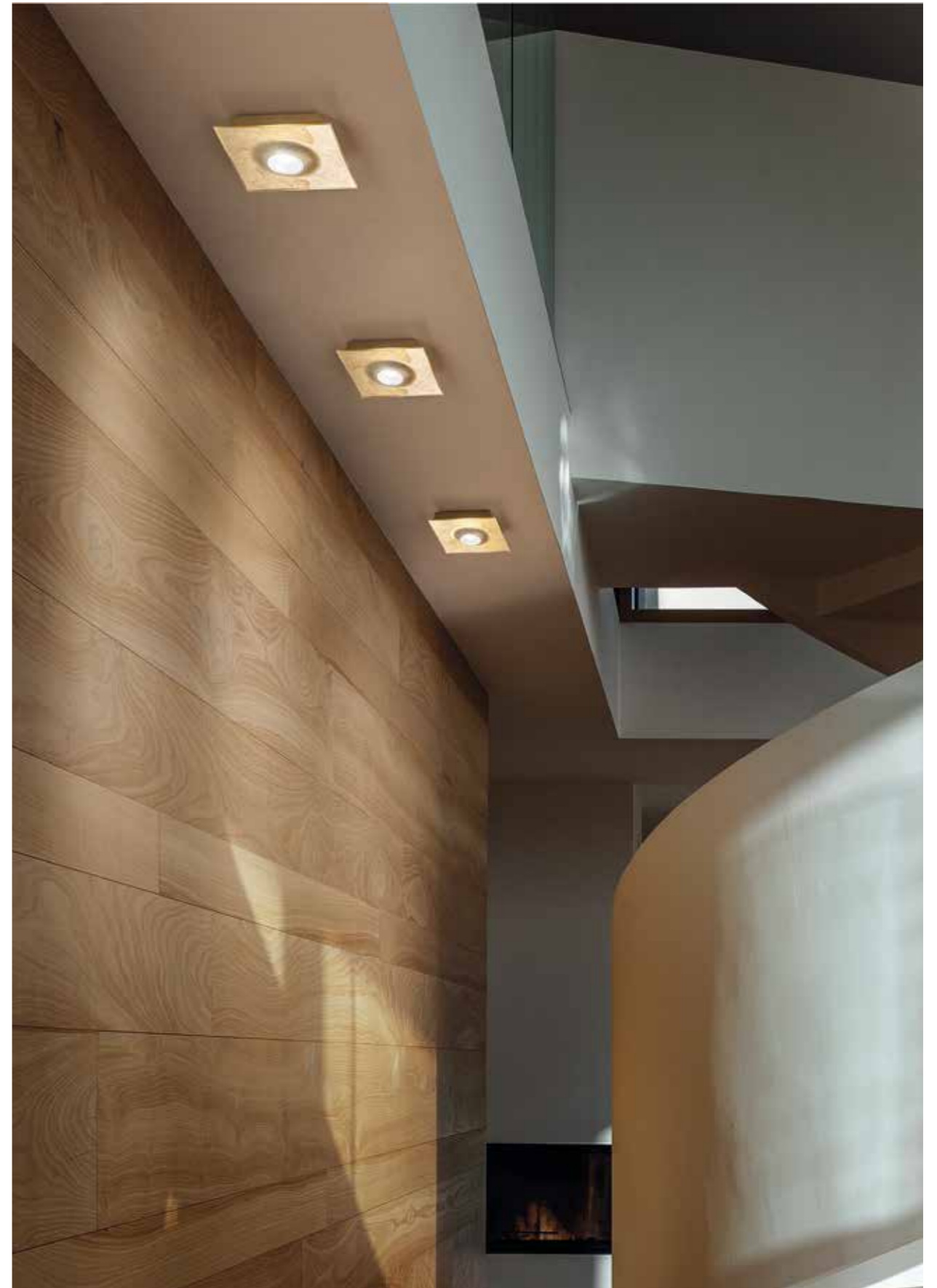

Art 02001 FO



Art 02003 FA



Art 02005 FO





Art 02007 NR



Art 02008 BB





Art 02004 BB

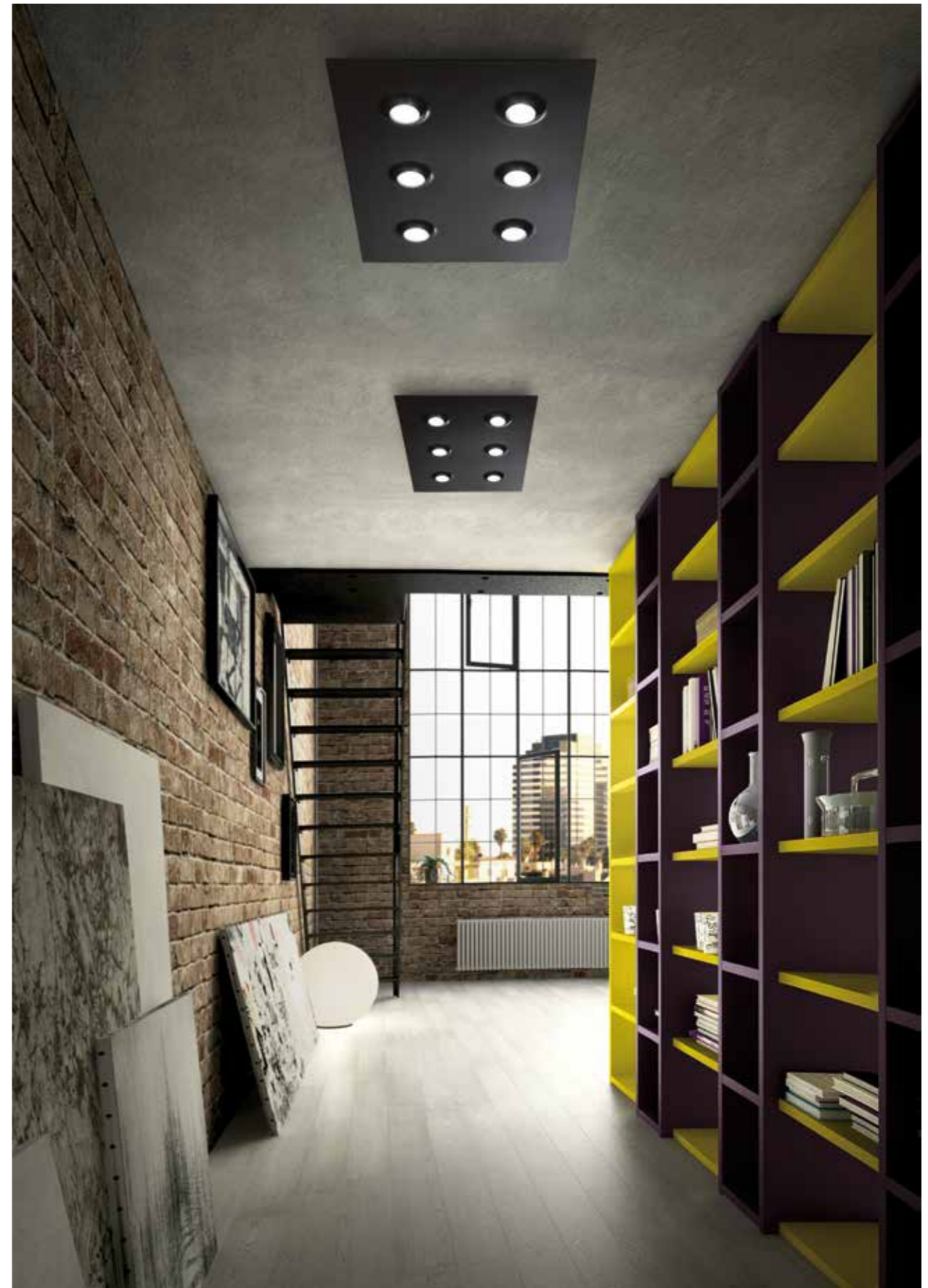

Art 02006 NR

02001

Ceiling lamp  
6,5 W  
790 Lumen  
CRI90

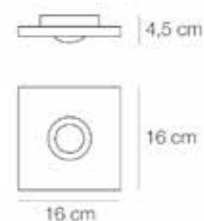

02002

Ceiling lamp  
13 W  
1580 Lumen  
CRI90

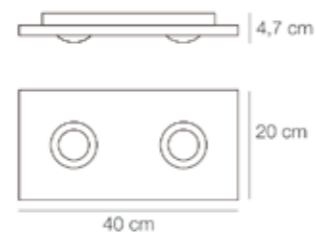

02003

Ceiling lamp  
19,5 W  
2370 Lumen  
CRI90

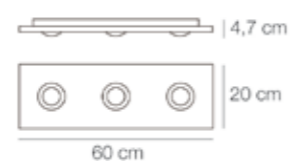

02005

Ceiling lamp  
26 W  
3160 Lumen  
CRI90

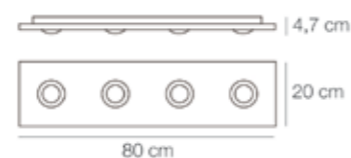

Structure	Dimmer	Led Light	Lens	IP	Diffuser
<b>XX</b>	<b>D</b> (Dimmer)	<b>H</b> 2700 K ● <b>W</b> 3000 K ● <b>N</b> 4000 K ○	<b>X</b> (No lens)	<b>X</b> (IP20) <b>P</b> (IP44)	BB □ FA ■ FO ■ NR ■

02007

Ceiling lamp  
39 W  
4740 Lumen  
CRI90

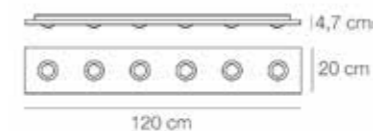

02004

Ceiling lamp  
26 W  
3160 Lumen  
CRI90

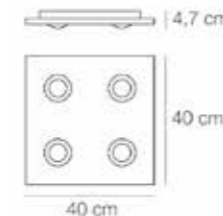

02006

Ceiling lamp  
39 W  
4740 Lumen  
CRI90

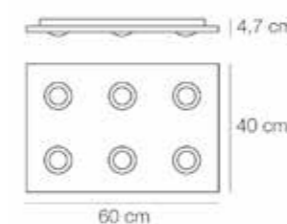

02008

Recessed lamp  
6,5 W  
790 Lumen  
CRI90

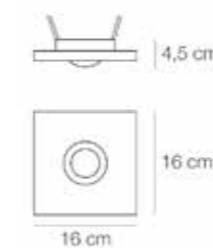

Structure	Dimmer	Led Light	Lens	IP	Diffuser
<b>XX</b>	<b>D</b> (Dimmer)	<b>H</b> 2700 K ● <b>W</b> 3000 K ● <b>N</b> 4000 K ○	<b>X</b> (No lens)	<b>X</b> (IP20) <b>P</b> (IP44)	BB □ FA ■ FO ■ NR ■

# Mir

Designer: Elesi Creative Lab

“Vetro, territorio e arte”  
“Glass, local traditions and art”



**DESIGN** Nella collezione Mir il design sobrio delle forme e l'innovazione tecnologica si uniscono in un risultato vincente: un'unica lastra di vetro piano con abbassamenti eseguiti a caldo e un sistema di fissaggio magnetico, veloce, semplice e senza viti a vista.

**DESIGN** In the Mir collection, simple shapes and technological innovation combine for a winning result: one single sheet of flat glass, with hot-pressed indentations, and a simple quick magnetic fastening system, with no visible screws.



**PERSONALITÀ** La forma geometrica della lampada è addolcita dai bassorilievi eseguiti in fusione a caldo del vetro. Essenziale, ma accattivante, possiede forte personalità grazie a questi dettagli che la rendono unica.

**PERSONALITY** The geometric shape of the light is softened by the hot-pressed indentations of the glass. Simple but eye-catching, it has a strong personality thanks to these details that make it unique.



**MAESTRIA** Il vetro, che rimanda alla tradizione del territorio, può essere decorato in foglia oro, lavorazione artigianale che dona a Mir l'unicità e la ricercatezza del «fatto a mano».

**EXPERTISE** The glass, a reminder of local tradition, can be decorated in gold leaf, an artisan technique that gives Mir the uniqueness and refined elegance of a handmade product.







Art 00703 FO

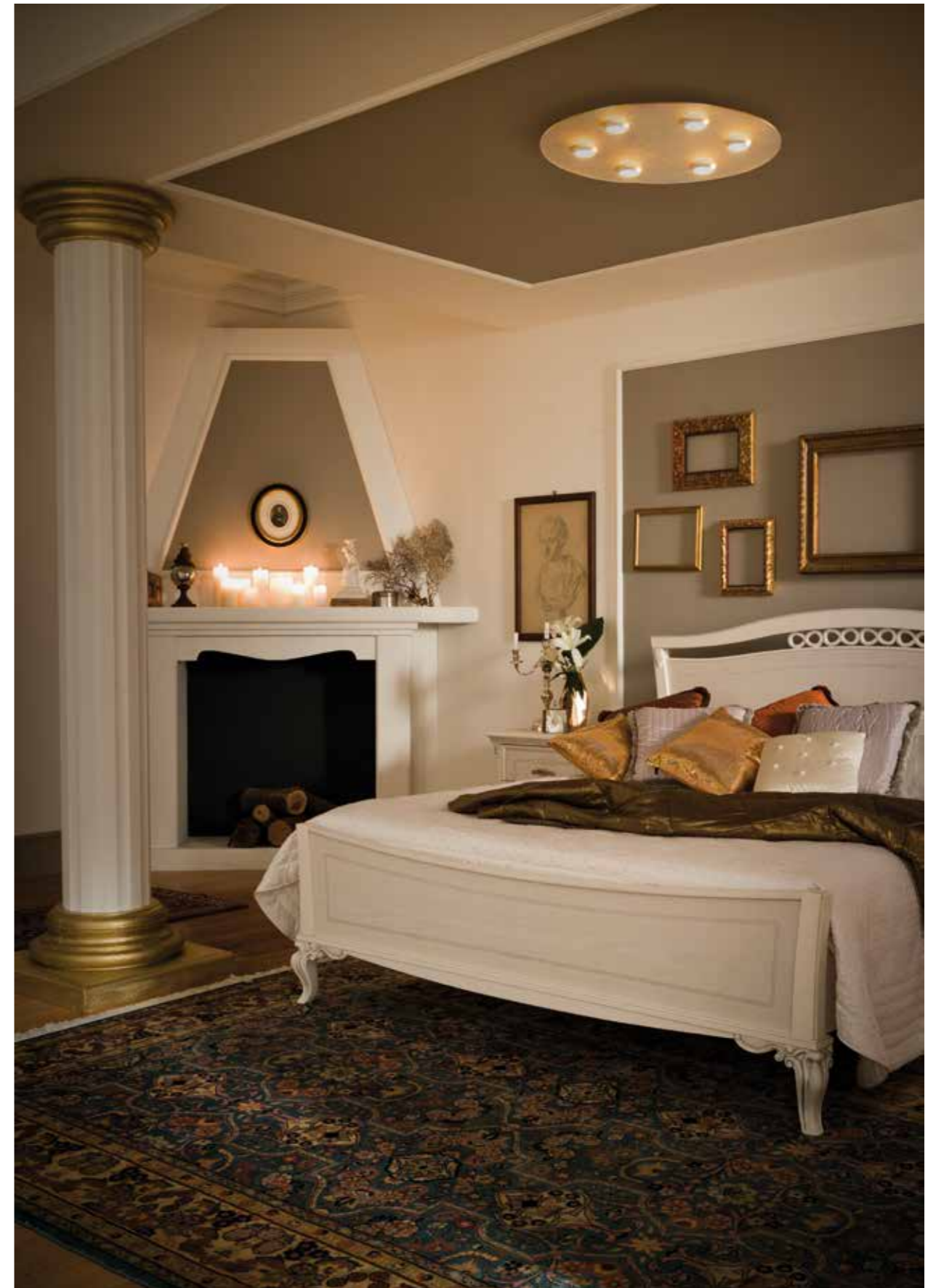

Art 00703 FO



Art 00702 BB



Art 00702 BB



Art 00705 FO



Art 00701 FA

**00701**

Ceiling lamp  
6,5 W  
790 Lumen  
CRI90



**00702**

Ceiling lamp  
19,5 W  
2370 Lumen  
CRI90

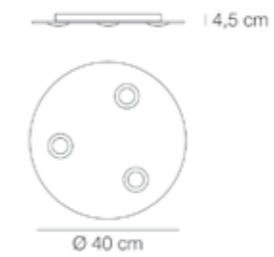

**00703**



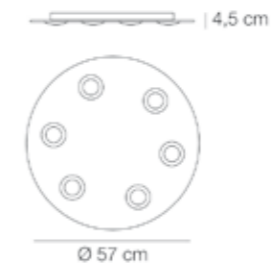



Ceiling lamp  
39 W  
4740 Lumen  
CRI90

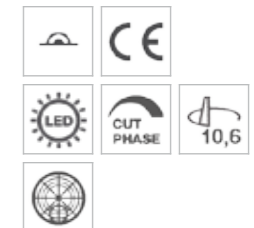

**00705**

Recessed lamp  
6,5 W  
790 Lumen  
CRI90



Structure	Dimmer	Led Light	Lens	IP	Diffuser
<b>XX</b>	<b>D</b> (Dimmer)	<b>H</b> 2700 K  <b>W</b> 3000 K  <b>N</b> 4000 K 	<b>X</b> (No lens)	<b>X</b> (IP20) <b>P</b> (IP44)	BB  FO  FA 



# Aura

Designer: Elesi Creative Lab

“Linee di luce che disegnano il vetro”  
“Glass designed by lines of light”



**DESIGN** Nella collezione Aura la bellezza del vetro si esalta nei colori e nella materia utilizzata. Il vetro è ricavato da una unica lastra e il suo design rimane integro, senza fori o tagli. L'effetto delle linee è dato dall'accostamento di lavorazioni diverse sul vetro.



**PERSONALITÀ** Il vetro colorato è interrotto da linee satiniate che permettono il passaggio della luce e diventano elementi distintivi. Temperamento magnetico: Il diffusore in vetro è fissato con un sistema a calamite che consente una installazione rapida e agevole.



**MAESTRIA** L'unicità è nel vetro che racchiude diverse lavorazioni artigianali: le decorazioni del vetro sono eseguite a mano da abili artigiani del territorio donando ad Aura l'unicità e la ricercatezza del «fatto a mano».

**DESIGN** In the Aura collection the beauty of the glass is enhanced by the colours and material used. The glass is obtained from one single sheet, without holes or cuts. The effect of the lines is created by the combined use of different work techniques on the glass.

**PERSONALITY** The coloured glass is interrupted by satin-finish lines that allow passage of the light and become distinctive elements. Magnetic temperament: the glass reflector is fixed by a magnet system which allows quick easy installation.

**EXPERTISE** The unique element of this lighting product is the glass which features different artisan techniques: the glass decorations are hand-done by skilled local craftsmen, giving Aura the uniqueness and refined elegance of a handmade product.

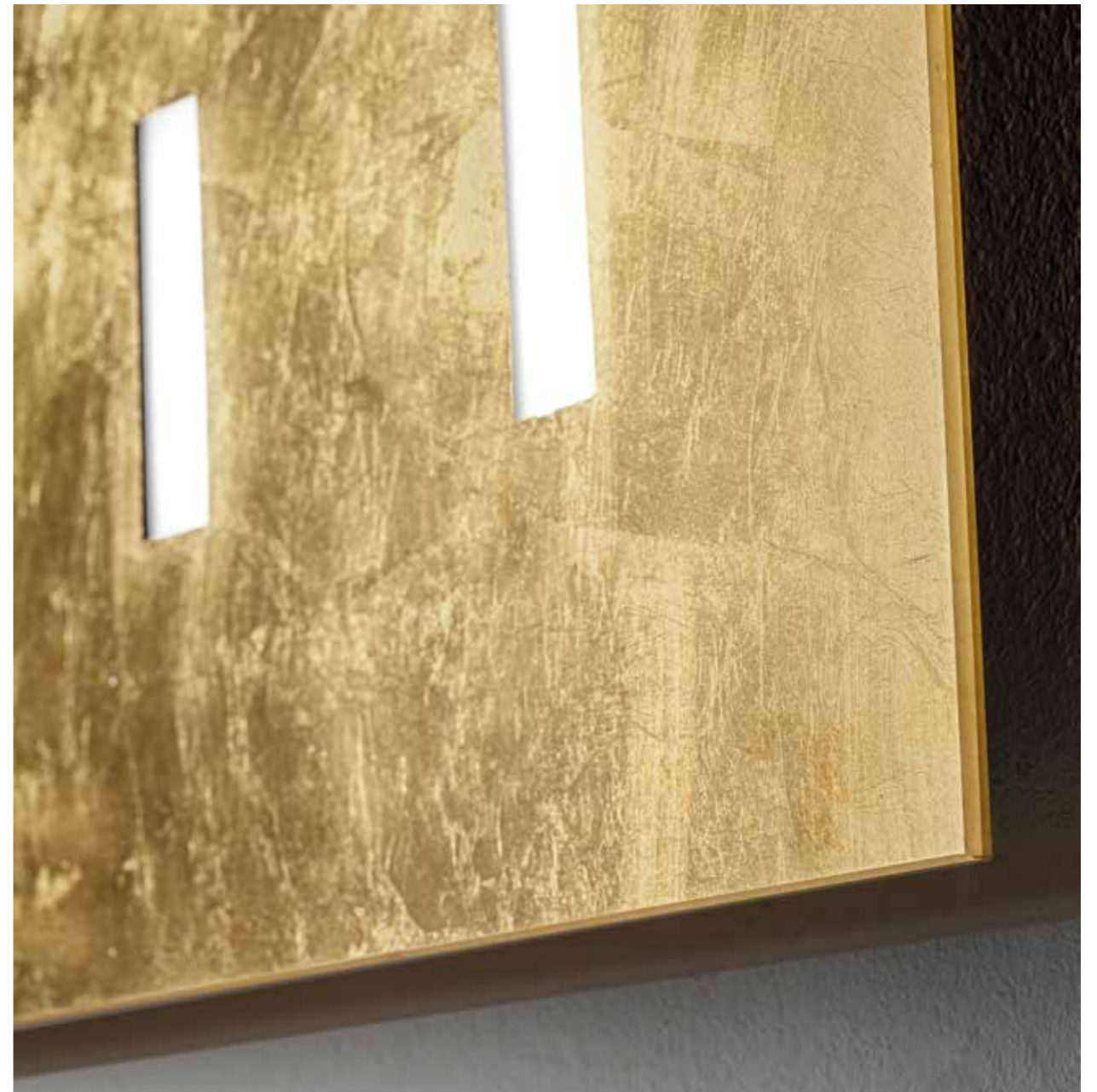



Art 02904 FO



Art 02905 BB

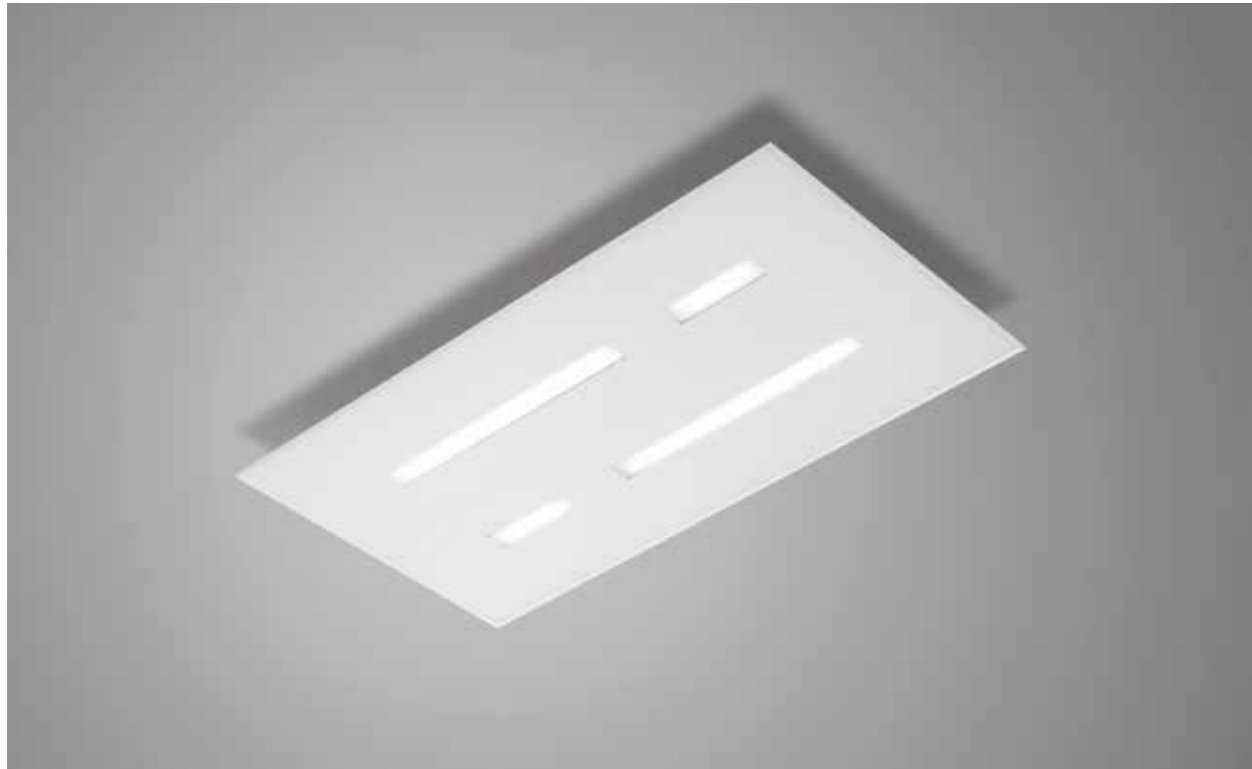

Art 02902 BB



Art 02903 FO



Art 02901 BB





Art 02907 FO

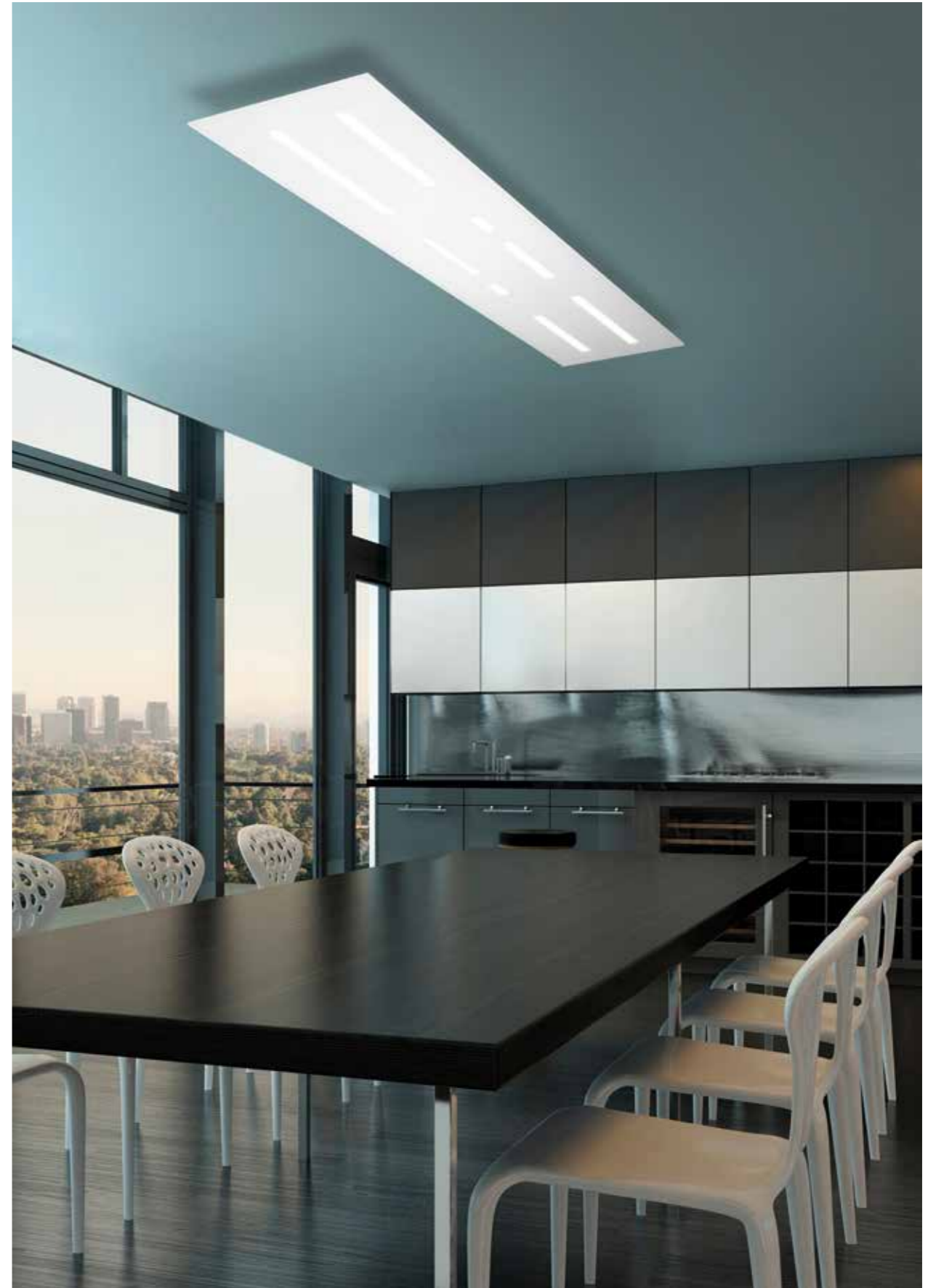

Art 02908 BB

02902

Ceiling lamp  
11,5 W  
1780 Lumen  
CRI90  
On request: Dali - 0/10V

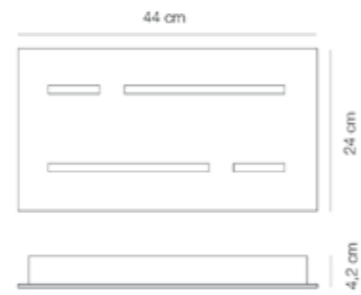

02903

Ceiling lamp  
17,5 W  
2650 Lumen  
CRI90  
On request: Dali - 0/10V



02907

Ceiling lamp  
26 W  
4000 Lumen  
CRI90  
On request: Dali - 0/10V

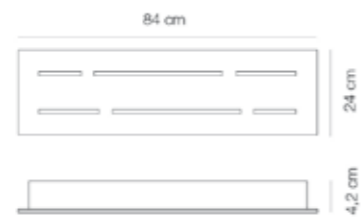

02908

Ceiling lamp  
37,5 W  
5800 Lumen  
CRI90  
On request: Dali - 0/10V

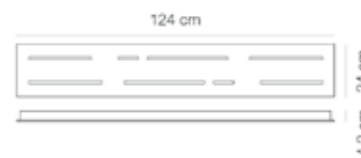

Structure	Dimmer	Led Light	Lens	IP	Diffuser
<b>XX</b>	<b>D</b> (Dimmer)	<b>H</b> 2700 K ● <b>W</b> 3000 K ● <b>N</b> 4000 K ○	<b>X</b> (No lens)	<b>X</b> (IP20) <b>P</b> (IP44)	BB □ FO ■

02901

Ceiling / Wall lamp  
6 W  
890 Lumen  
CRI90  
On request: Dali - 0/10V

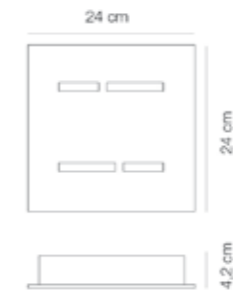

02904

Ceiling lamp  
20,7 W  
3200 Lumen  
CRI90  
On request: Dali - 0/10V



02905

Ceiling lamp  
37,5 W  
5800 Lumen  
CRI90  
On request: Dali - 0/10V

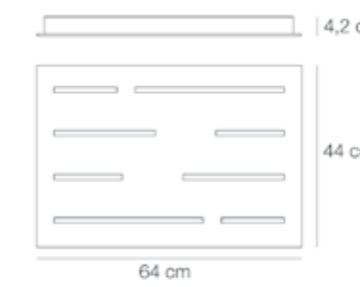

Structure	Dimmer	Led Light	Lens	IP	Diffuser
<b>XX</b>	<b>D</b> (Dimmer)	<b>H</b> 2700 K ● <b>W</b> 3000 K ● <b>N</b> 4000 K ○	<b>X</b> (No lens)	<b>X</b> (IP20) <b>P</b> (IP44)	BB □ FO ■



*“Volumi che si sovrappongono, si uniscono creando combinazioni di forme dalle quali sgorga la luce”*

*La città, come il mare e lo spazio, suscita emozioni, solletica punti di vista diversi. Un ambiente che può amplificare o contrarre gli spazi in base al punto di osservazione.*

Narciso / Doc / Dado

*“Overlapping volumes that merge creating combinations of shapes where the light flows from”*

*The city, as well as the sea and the space, evokes emotions, arouses different points of view. A setting able to amplify and contract the spaces depending on the observation point.*





# Narciso

Designer: Elesi Creative Lab

“Attragente riferimento nello spazio”  
“A fascinating landmark in the space”



**DESIGN** Un tuffo nelle origini partendo dal concetto di “lampara” classica, Narciso è una collezione che esprime l’idea di luce come punto di riferimento nello spazio. Le forme, semplici e sovrapposte, guidano e definiscono la diffusione della luce.

**DESIGN** A dive into the origins starting from the concept of the classical “lamp” (“lampara”), Narciso is meant to be a collection expressing the idea of light as a landmark in the space. The overlapped and plain shapes lead and define the light diffusion.



**PERSONALITÀ** Oggetto dall’elegante forza espressiva. Narciso attrae lo sguardo. Quando si accende, la parte inferiore del diffusore conico riflette la sua stessa luce, mettendo in risalto la sua forma e la sua finitura.

**PERSONALITY** It is an object characterized by an elegant expressive impact. Narciso catches the eye. When it is turned on, the bottom part of the conical diffuser reflects its own light, emphasising its shape and its finish.



**MAESTRIA** Design funzionale per il rosone ad aggancio magnetico che assicura un’installazione agevole e veloce. Ricercatezza nella scelta del cavo rivestito in tessuto. Ogni particolare è studiato e preparato con cura.

**EXPERTISE** The canopy has a functional design with a magnetic coupling that ensures an easy and fast installation. The fabric-covered cable is the result of a refined choice. Each detail is studied and prepared carefully.





Art 05301 BE

Art 05302 BE





Art 05302 ON

Art 05301 ON



Art 05302 AN





Art 05302 AN

Art 05303 AN



Art 05304 ON



Art 05304 AN



Art 05305 ON

Art 05306 ON

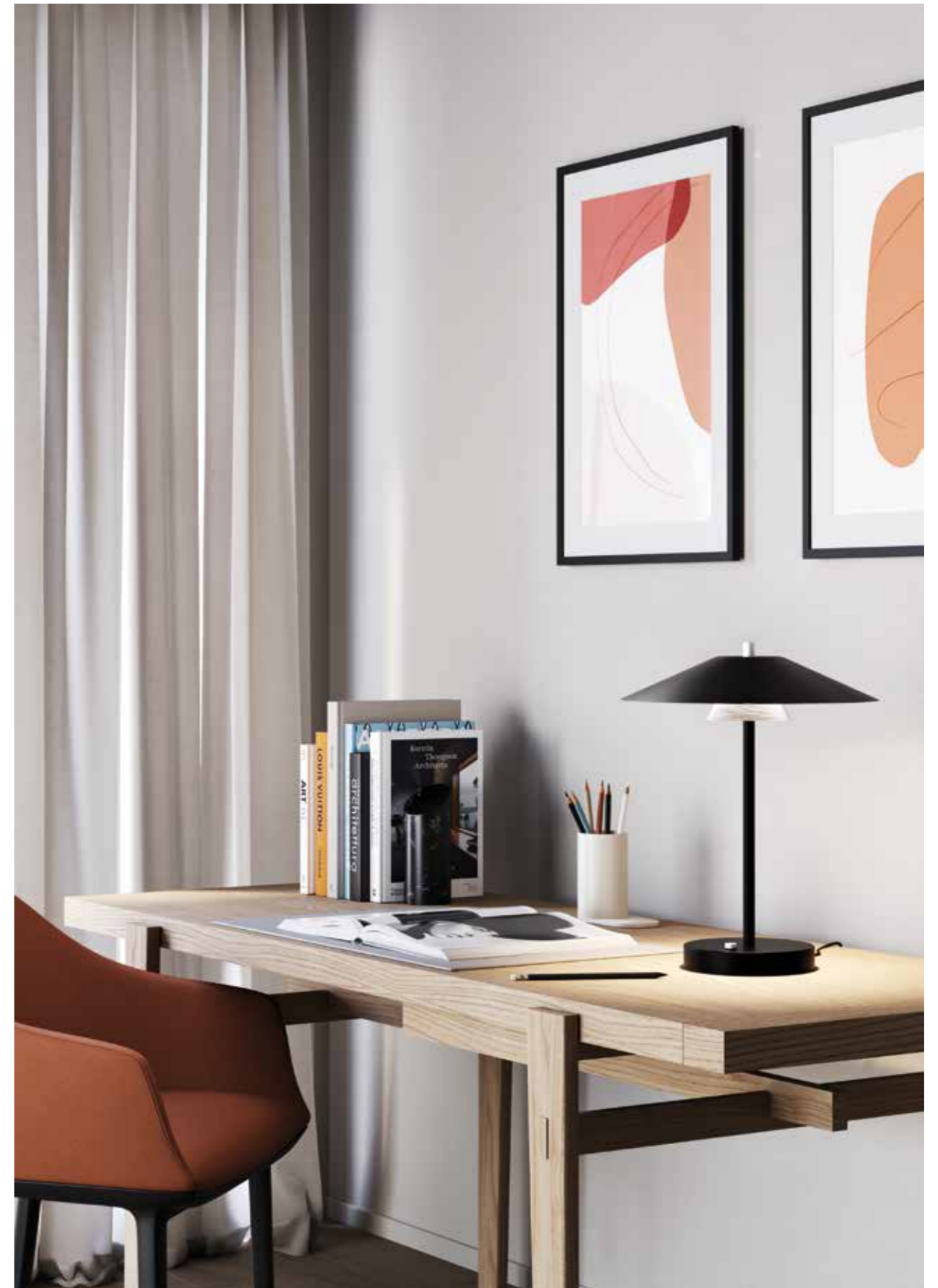

Art 05306 AN





Art 05307 AN



Art 05307 ON

05301

Suspension  
7 W  
1100 Lumen  
CRI90



05302

Suspension  
12 W  
1700 Lumen  
CRI90



05303

Suspension  
3x6 W  
3x850 Lumen  
CRI90



05304

Wall lamp  
7 W  
1100 Lumen  
CRI90

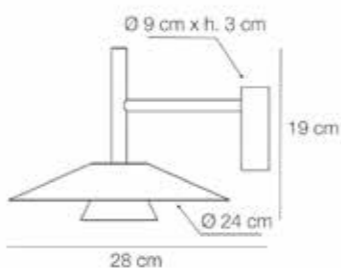

Structure	Dimmer	Led Light	Lens	IP	Diffuser
AN	D (Dimmer)	H 2700 K	X (No lens)	X (IP20)	XX
BE		W 3000 K			
NR		N 4000 K			
ON					

05305

Table lamp  
7 W  
1100 Lumen  
CRI90

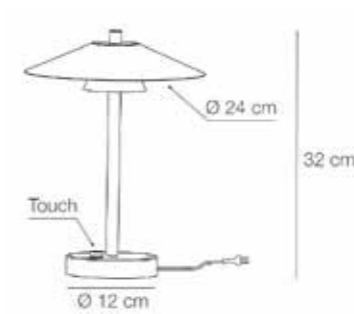

05306

Table lamp  
12 W  
1700 Lumen  
CRI90



05307

Floor lamp  
12 W  
1700 Lumen  
CRI90



Structure	Dimmer	Led Light	Lens	IP	Diffuser
AN	T (Touch)	H 2700 K	X (No lens)	X (IP20)	XX
BE		W 3000 K			
NR		N 4000 K			
ON					

# Doc

Designer: Elesi Creative Lab

“Funzionalità e praticità”  
“*Functionality and practicality*”



**DESIGN** Progettata come lampada da lettura, studio e lavoro consente di orientare la luce secondo le proprie necessità, regolando l'intensità con memory touch dimmer. Dotata di 3 snodi, mette in luce lo spazio desiderato creando il giusto comfort visivo.

**DESIGN** *Designed as a light for reading, studying and working, it allows you to direct the light as required, adjusting the intensity by memory touch dimmer. Provided with 3 joints, it highlights the desired area, ensuring visual comfort.*



**PERSONALITÀ** Stabile, maneggevole, funzionale. Doc è semplicemente pratica, una lampada che offre una soluzione rapida per illuminare il piano di lavoro, la scrivania, l'angolo relax.

**PERSONALITY** *Stable, handy, functional. Doc is simply practical, a lamp that offers a quick solution for lighting the work top, the desk and the relaxation corner.*



**MAESTRIA** La cura nel dettaglio trova la massima espressione nella spazzolatura del metallo, lavorazione di finitura eseguita completamente a mano. Quell'artigianalità che conferisce unicità a ciascuna lampada.

**EXPERTISE** *Attention to detail reaches a high point in the metal brushing, a finishing process carried out 100% by hand. Craftsmanship that makes each product unique.*







Art 05101 AS / Art 05101 OS / Art 05101 BB



Art 05101 NR



Art 05102 AS

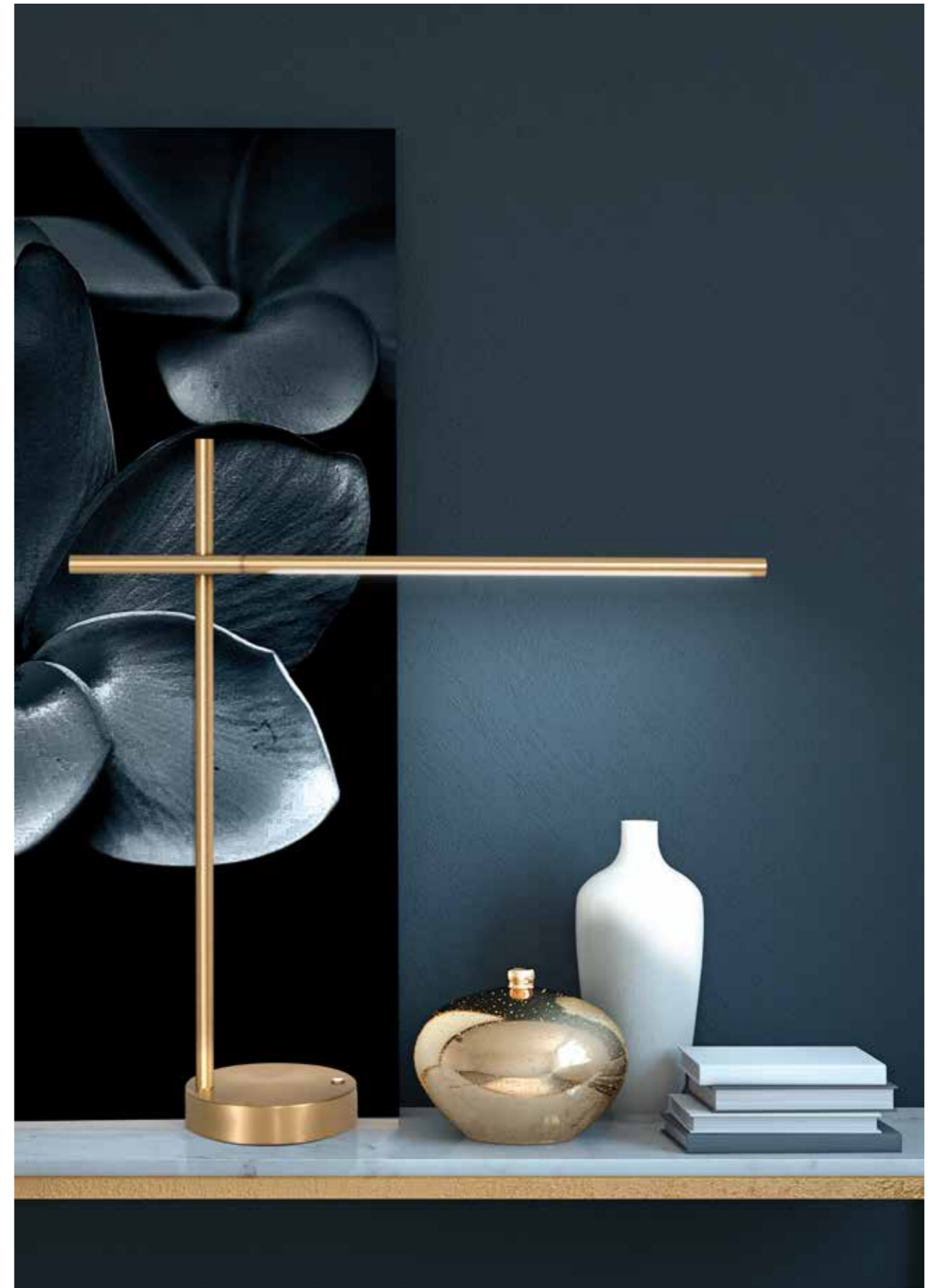

Art 05103 OS



Art 05103 NR

05101

Table lamp  
6,5 W  
780 Lumen  
CRI90

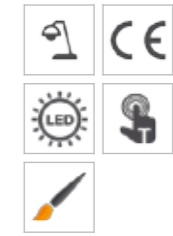
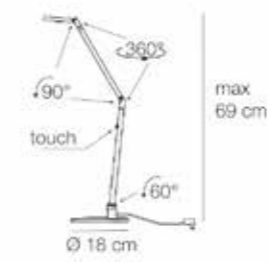

05102

Floor lamp  
6,5 W  
780 Lumen  
CRI90

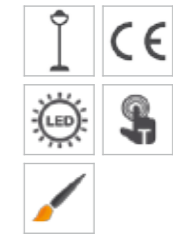

05103

Table lamp  
6 W  
900 Lumen  
CRI90

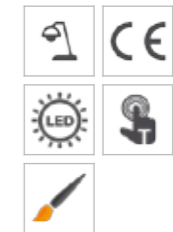

Structure	Dimmer	Led Light	Lens	IP	Diffuser
AS	<b>T</b> (Touch)	<b>H</b> 2700 K	<b>X</b> (No lens)	<b>X</b> (IP20)	<b>XX</b>
BB		<b>W</b> 3000 K			
NR		<b>N</b> 4000 K			
OS					



# Dado

Designer: Elesi Creative Lab

“La semplicità si veste di luce”  
“Simplicity dressed in light”



**DESIGN** Dado è una collezione di applique compatte, elettrificate con attacco GX53. La sua forma geometrica consente di creare combinazioni a parete, giochi di forme che diventano parte dell'arredo nel quale sono inserite.

**DESIGN** Dado is a collection of compact wall lights, electrified with GX53 fitting. Its geometric shape offers plenty of scope for different combinations, playing on changing shapes and forms that become part of the furnishing scheme.



**PERSONALITÀ** E' compatta, semplice e lineare senza essere banale. Pura forma, la si sintonizza con i diversi stili di arredamento, esaltandone lo spazio e creando con la luce suggestivi effetti di chiaro/scuro.

**PERSONALITY** Compact, simple and linear without being banal. Its pure form blends in with different furnishing styles, highlighting the space and creating striking chiaroscuro lighting effects.



**MAESTRIA** La cura nel dettaglio trova la massima espressione nella spazzolatura del metallo, lavorazione di finitura eseguita completamente a mano. Quell'artigianalità che conferisce unicità a ciascuna lampada

**EXPERTISE** Attention to detail reaches a high point in the metal brushing, a finishing process carried out completely by hand. An artisan touch that makes each light unique.





Art 04101 OS



Art 04102 AC

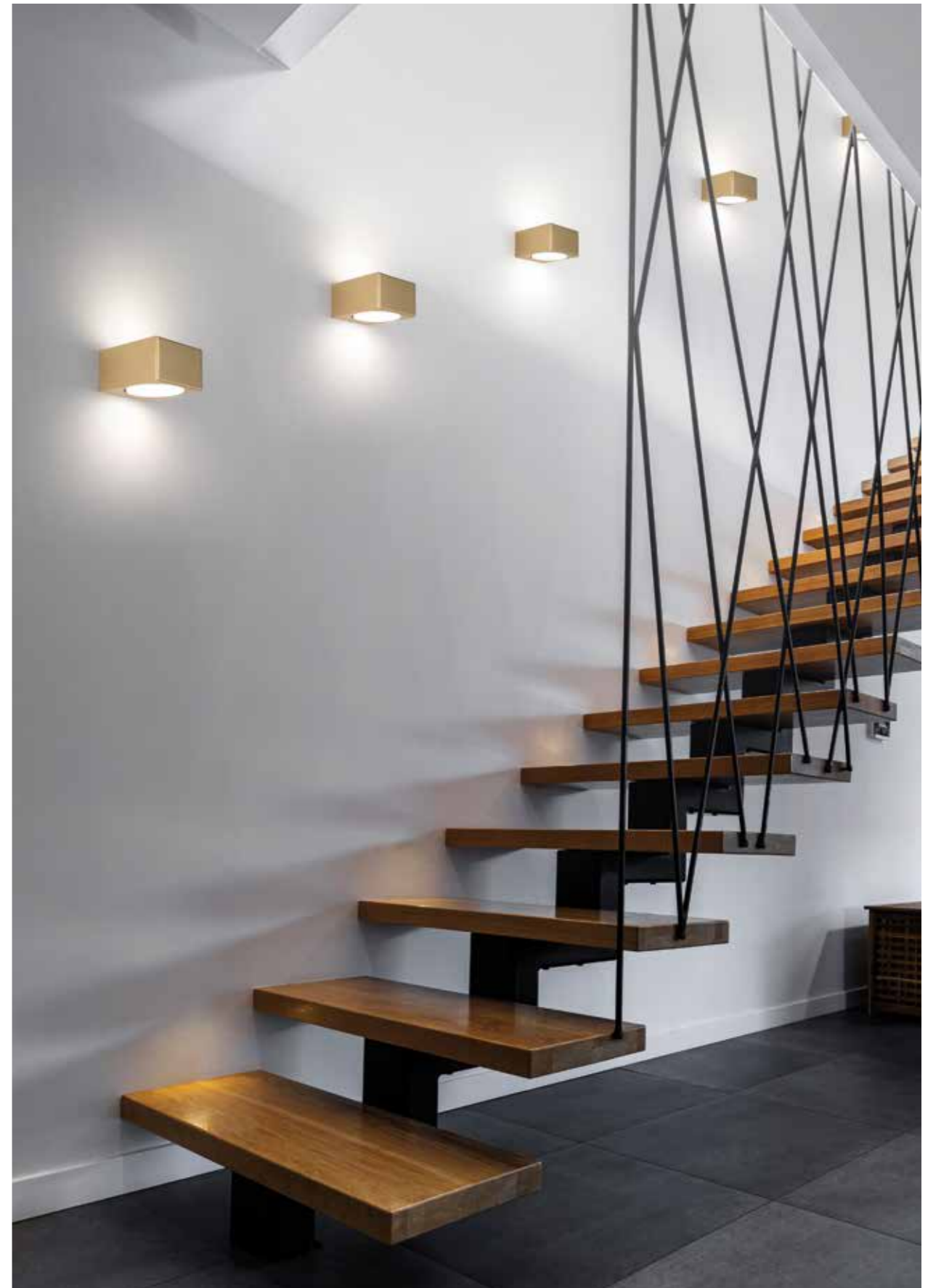

Art 04102 OS



Art 04104 NR



Art 04107 BB



Art 04107 BB





Art 04106 OS



Art 04106 BB

04101

Wall lamp  
GX53 1x7 W  
Lampadina non inclusa  
Bulb not included

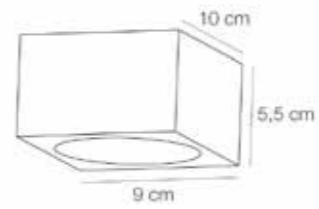

04102

Wall lamp  
GX53 2x7 W  
Lampadina non inclusa  
Bulb not included

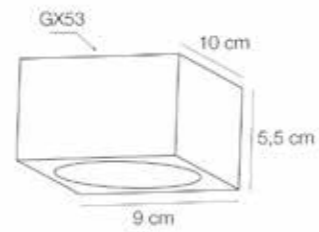

04104

Wall lamp  
GX53 4x7 W  
Lampadina non inclusa  
Bulb not included

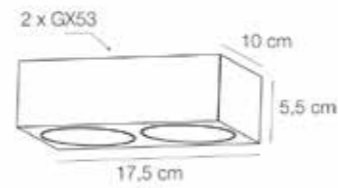

04107

Wall lamp  
GX53 4x7 W  
Lampadina non inclusa  
Bulb not included

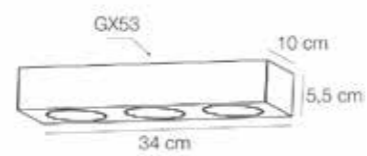

Structure	Dimmer	Led Light	Lens	IP	Diffuser
AC	<b>X</b> (No Dimmer)	<b>X</b>	<b>X</b> (No lens)	<b>X</b> (IP20)	<b>XX</b>
BB					
NR					
OS					

04106

Wall lamp  
GX53 4x7 W  
Lampadina non inclusa  
Bulb not included

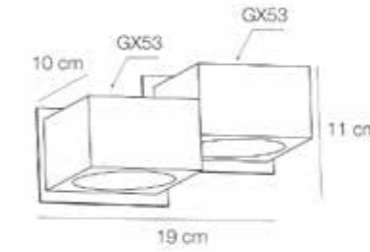

Structure	Dimmer	Led Light	Lens	IP	Diffuser
AC	<b>X</b> (No Dimmer)	<b>X</b>	<b>X</b> (No lens)	<b>X</b> (IP20)	<b>XX</b>
BB					
NR					
OS					



*“La dinamicità di poter creare soluzioni,  
la libertà di scegliere ogni passo”*

*Le esigenze cambiano nel tempo, soffitti e pareti sono spesso  
immutabili, ma la luce non lo è, si adatta al cambiamento  
per poter arrivare sempre nel posto giusto.*

Eviva Plus / Composizioni



*“A dynamism able to build solutions,  
the freedom to choose each step”*

*Needs change over time, ceilings and walls  
are often immutable, but the light is not. It adapts  
to change to be able to get to the right place.*



# Eviva Plus

Designer: Maurizio Betteto

“Un sistema modulare unico”  
“A unique modular system”



**DESIGN** Eviva è un sistema LED monotubo modulare dal design minimal per creare soluzioni illuminotecniche personalizzate. Il tubo elettrificato, di un diametro di appena 6 mm, è componibile e per questo estremamente adattabile alle diverse esigenze.

**DESIGN** Eviva is a modular single-tube LED system featuring a minimalist design to create customized lighting solutions. The electrified tube, with diameter of just 6 mm, is modular and therefore extremely adaptable to different needs.



**PERSONALITÀ** Eviva illumina gli ambienti esaltando il tuo stile grazie ai suoi elementi modulari che permettono di realizzare soluzioni personalizzate, alle sorgenti di luce orientabili che mettono in evidenza gli oggetti sui quali si posano.

**PERSONALITY** Eviva lighting enhances your style thanks to its modular elements that can be used to create customized solutions and the adjustable light sources that highlight individual objects.



**MAESTRIA** Eviva è un sistema a led integrati brevettato da Elesi Luce. La cura nel dettaglio trova la massima espressione nella spazzolatura del metallo, lavorazione di finitura eseguita completamente a mano.

**EXPERTISE** Eviva is an integrated LED system patented by Elesi Luce. Attention to detail reaches a high point in the metal brushing, a finishing process carried out 100% by hand.





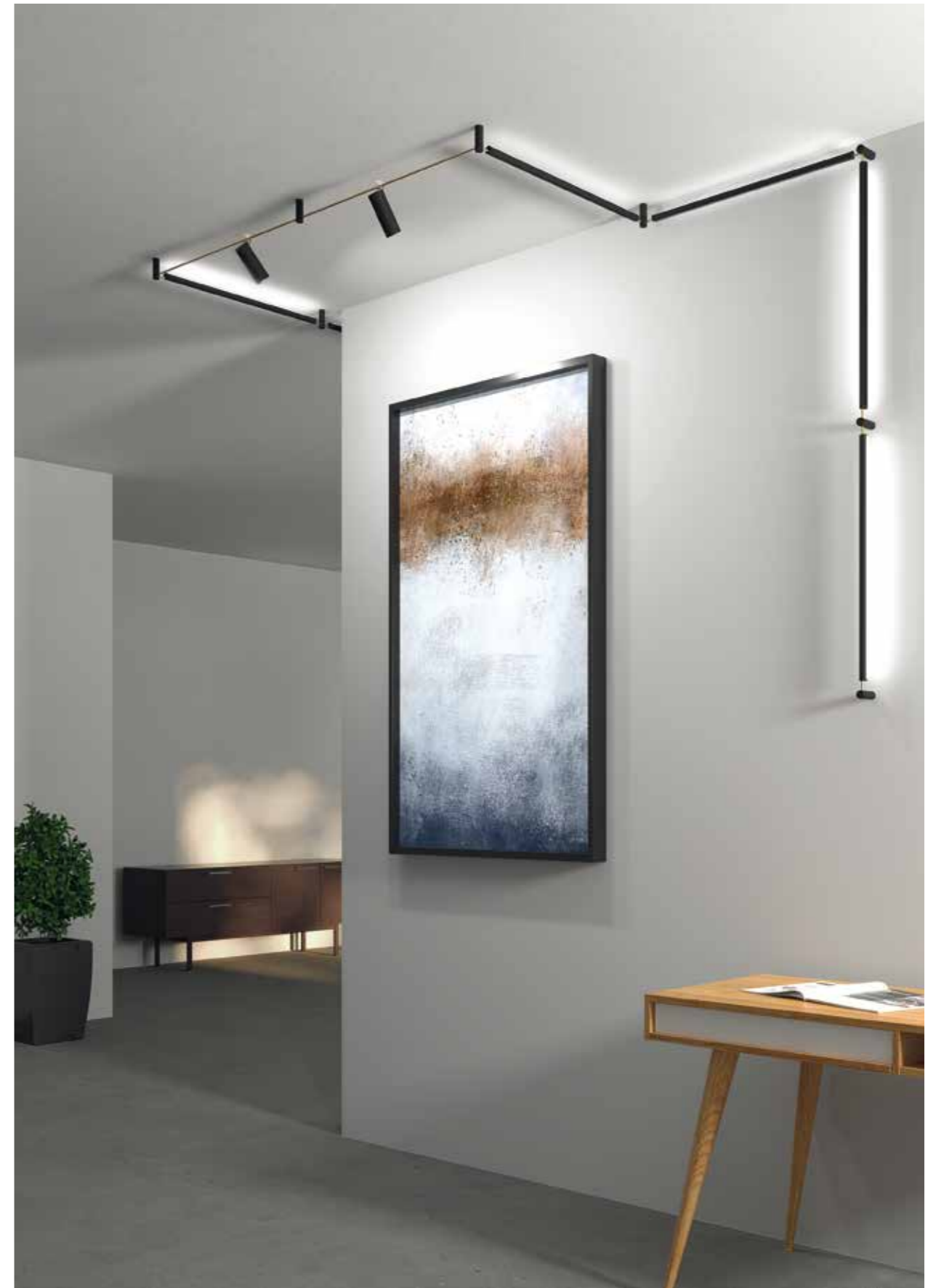





Variable optic 15° - 45°

Variable optic 20° - 50°

Optic 25°

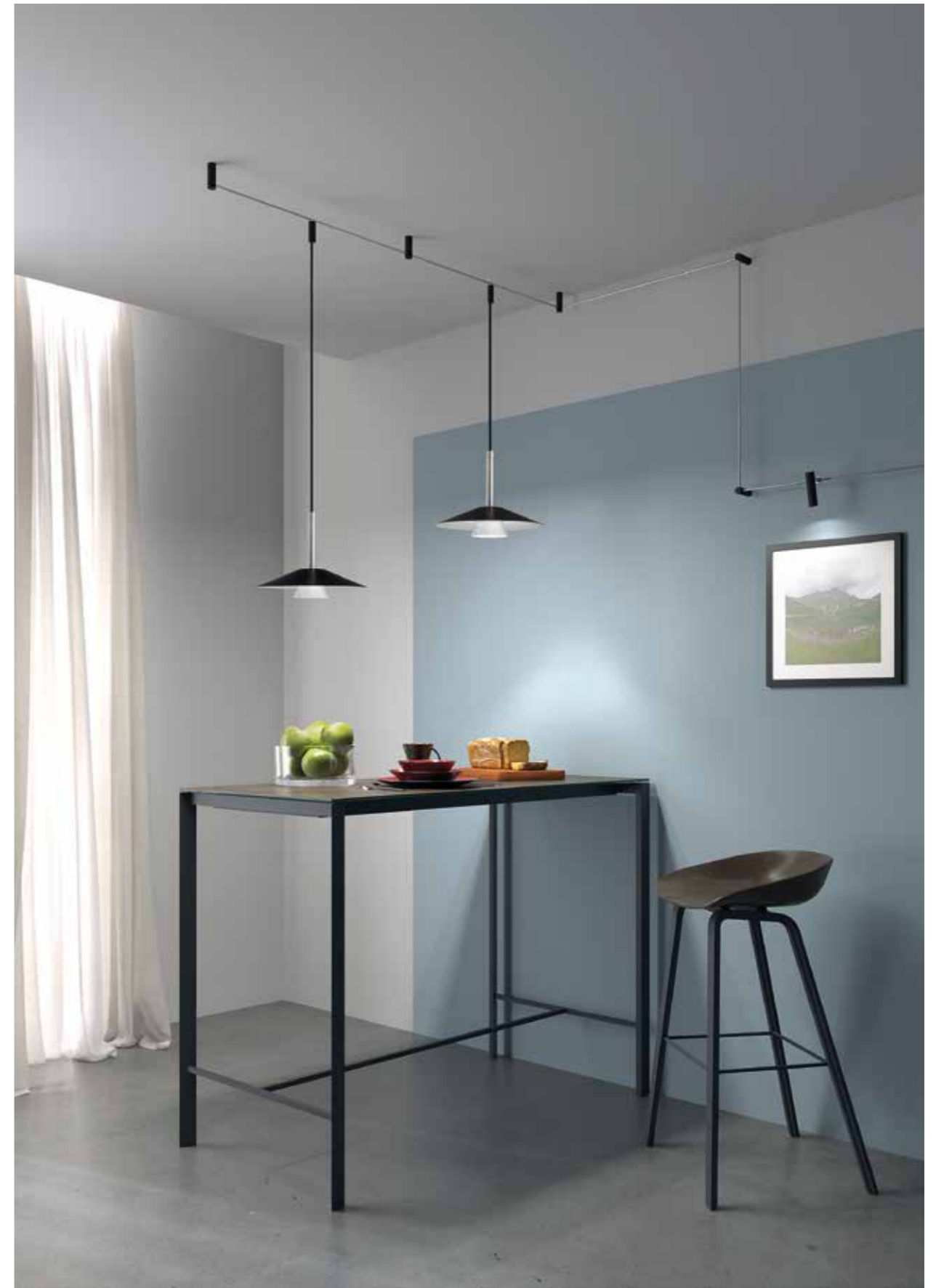

## Il Sistema in 2 Passaggi - Step 1

Traccia un percorso che colleghi le zone da illuminare utilizzando i moduli da 72 cm con supporti.

Identifica le tue aree da illuminare.

Scegli il tipo di sorgente luminosa.

## Eviva Plus in 2 steps - Step 1

Trace a path connecting the areas to be lit using the 72 cm modules and with fixing elements.

Identify the areas to be lit.

Choose the type of light source.



Spotlight

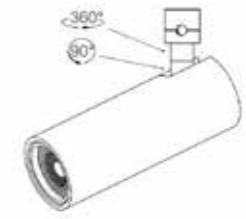

LED Linear Element



Suspension



## Il Sistema in 2 Passaggi - Step 2

Calcola il consumo complessivo delle sorgenti luminose e scegli l'alimentatore corretto.

## Eviva Plus in 2 steps - Step 2

Calculate the total consumption of the light sources and choose the correct power supply.





10101

Spot light ottica fissa 25° -  
Fixed optic 25°  
3 W  
450 Lumen  
CRI90

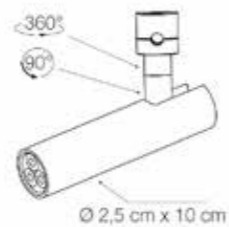

10102







Spot light ottica 20°- 50° - Only  
Variable optics 20°-50°  
6,5 W  
780 Lumen  
CRI90

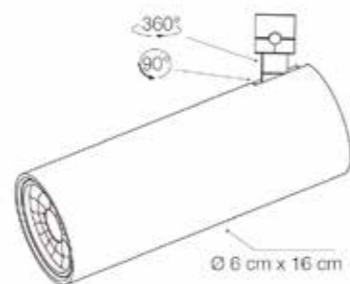

10103

Spot light ottica 15°- 45° - Only  
Variable optics 15°- 45°  
9 W  
1180 Lumen  
CRI90



Structure	Dimmer	Led Light	Lens	IP	Diffuser
AC  OF 	<b>D</b> (Dimmer)	<b>H</b> 2700 K  <b>W</b> 3000 K  <b>N</b> 4000 K 	<b>2</b> (25°) <b>V</b> (Variable)	<b>X</b> (IP20)	BB  NR 

10104



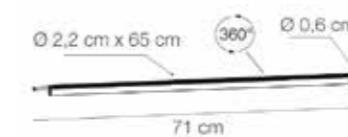



LED Linear element  
9,5 W  
1400 Lumen  
CRI90

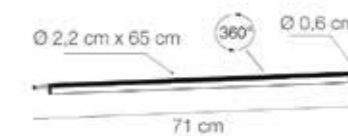

10105

LED Linear element  
14,5 W  
2150 Lumen  
CRI90



Structure	Dimmer	Led Light	Lens	IP	Diffuser
AC  OF 	<b>D</b> (Dimmer)	<b>H</b> 2700 K  <b>W</b> 3000 K  <b>N</b> 4000 K 	<b>X</b> (No lens)	<b>X</b> (IP20)	BB  NR 

10111







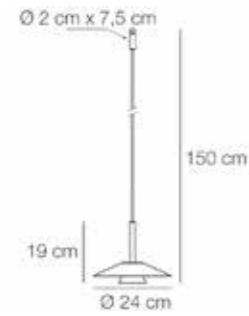

Suspension  
6 W  
850 Lumen  
CRI90



10112

Suspension  
6 W  
850 Lumen  
CRI90



Structure	Dimmer	Led Light	Lens	IP	Diffuser
AC 	<b>D</b> (Dimmer)	<b>H</b> 2700 K 	<b>X</b> (No lens)	<b>X</b> (IP20)	AN 
OF 		<b>W</b> 3000 K 			NR 
		<b>N</b> 4000 K 			ON 

101S1

Supporto soffitto/parete 4 fori -  
Fixing element for ceiling/ wall 4  
holes

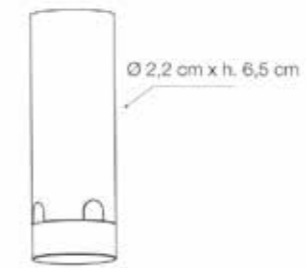

101B1

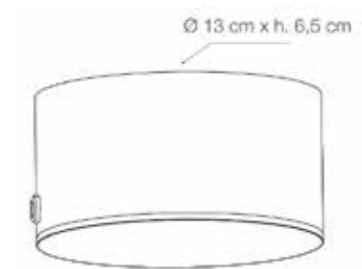

Copri alimentatore con 1 foro -  
Covering for power supply 1  
hole

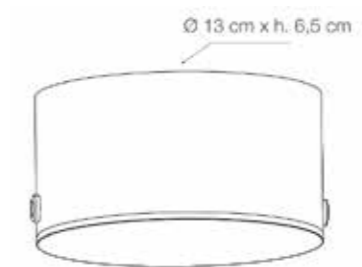

101B2

Copri alimentatore con 2 fori -  
Covering for power supply 2  
holes



Structure	Dimmer	Led Light	Lens	IP	Diffuser
BB 	<b>X</b> (No Dimmer)	<b>X</b>	<b>X</b> (No lens)	<b>X</b> (IP20)	<b>XX</b>
NR 					

**101T1**

Tubo lung. 71 cm con cavo -  
Tube 71 cm with cable



**101F1**

Flex 32 cm



**101F2**

Giunzione tubo/alimentatore -  
Tube/Power supply junction

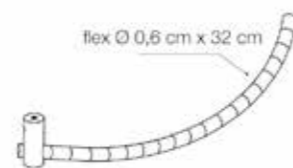

Structure	Dimmer	Led Light	Lens	IP	Diffuser
AC	<b>X</b> (No Dimmer)	<b>X</b>	<b>X</b> (No lens)	<b>X</b> (IP20)	<b>XX</b>
OF					

**Alimentatori / Power supply**

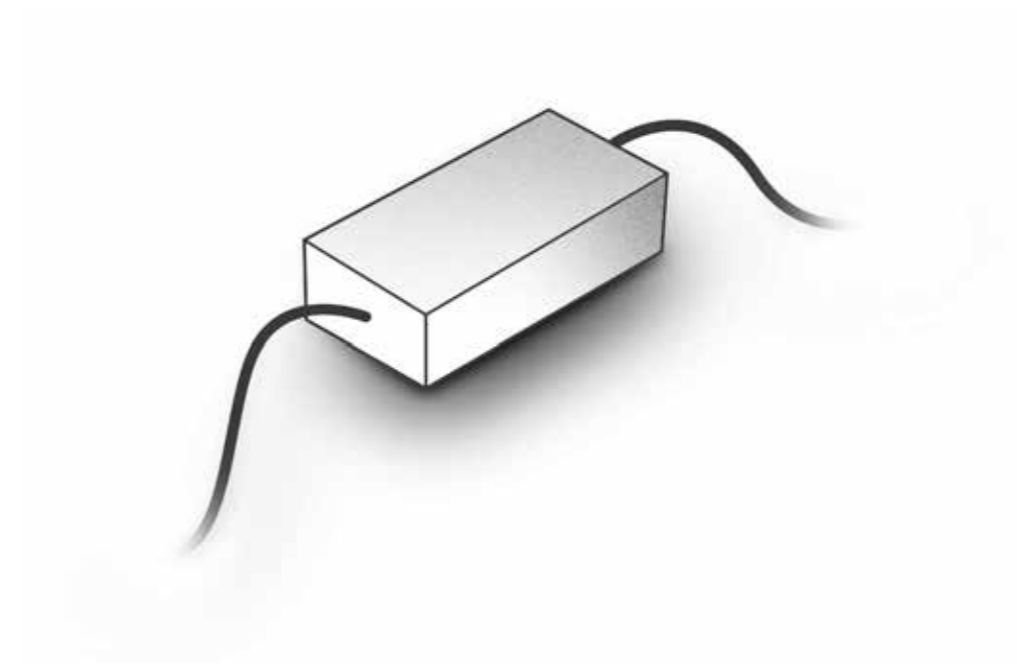

Watt	Dimmer	Codice / Code
60 W	No Dimmer	<b>101D1</b>
60 W	Dimmer Push 0/10V Dali	<b>101D2</b>
100 W	No Dimmer	<b>101D3</b>
100 W	Dimmer Push 0/10V Dali	<b>101D4</b>
150 W	No Dimmer	<b>101D5</b>
150 W	Dimmer Push 0/10V Dali	<b>101D6</b>

**ON REQUEST DIMMER WI-FI**



# Composizioni

“A modo tuo”  
“In your own way”



**DESIGN** Crea la composizione di luce più adatta al tuo ambiente e al tuo stile. Sono a disposizione strutture a soffitto che si combinano con pendenti di diverse forme e dimensioni per poter soddisfare esigenze puntuali e uniche.

**DESIGN** You can create the most suitable light composition to your environment and style. The ceiling structures are available and they match with hanging models characterized by different shapes and sizes, in order to fulfill ad hoc and unique needs.



**PERSONALITÀ** Le molteplici scelte tra modelli di pendenti e di struttura e la variabile delle finiture rendono i componenti estremamente personalizzabili. Si adattano con molta flessibilità alle necessità specifiche dello spazio da illuminare.

**PERSONALITY** The multiple choices among the hanging models and structures and the range of finishes make compositions extremely customized. They adapt to specific needs of the space to be lighted with great flexibility.



**MAESTRIA** Ciascun elemento richiama una collezione del catalogo, mantenendo la propria personalità. La struttura a soffitto è realizzata per poter dare la massima flessibilità nella progettazione illuminotecnica degli ambienti.

**EXPERTISE** Each element recalls a collection in the catalogue, keeping its own personality. The ceiling structure is made to allow the highest flexibility in the interior lighting design.

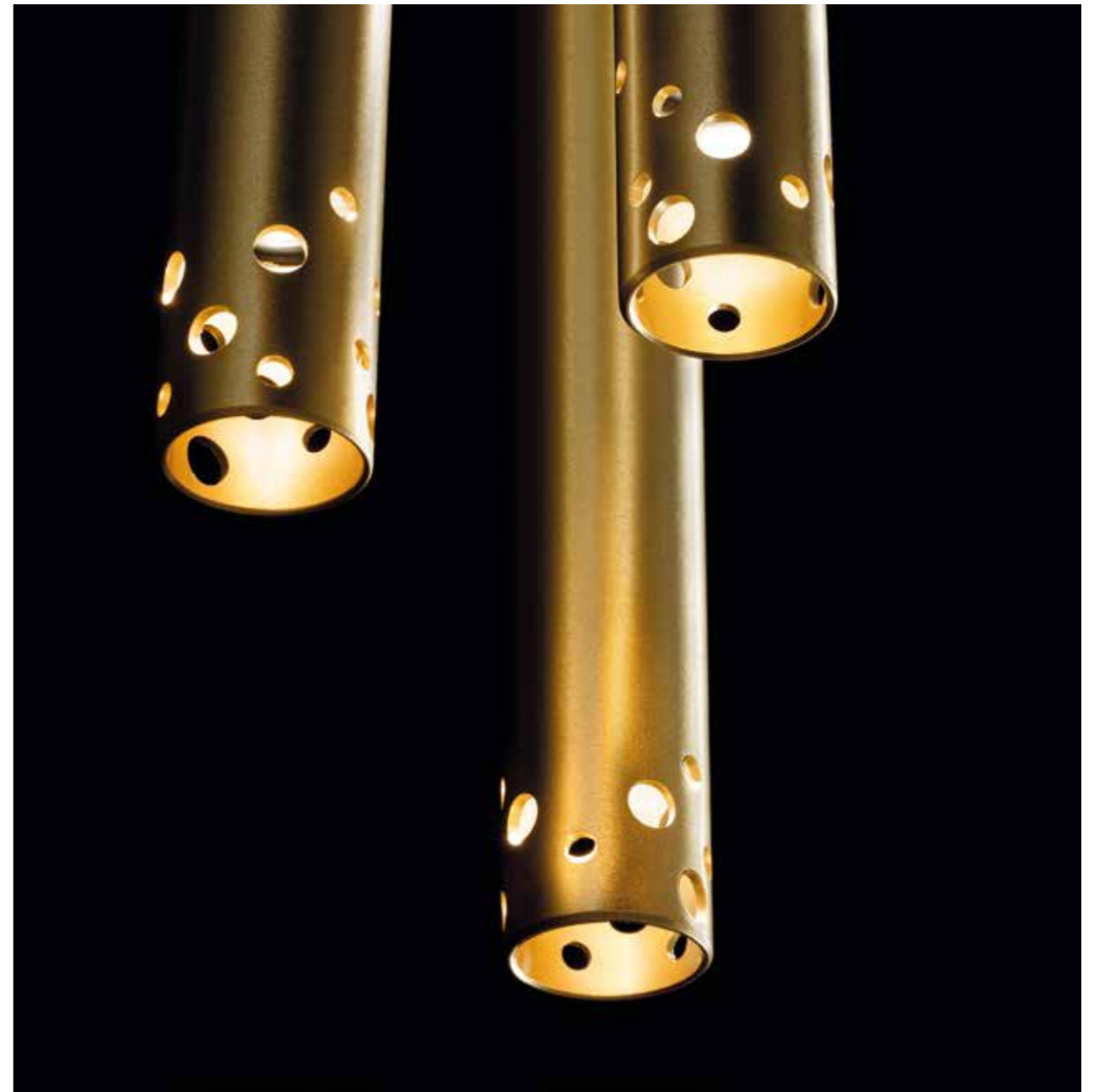



Art 20003 NR / 3x Art 20015 NG / 3x Art 20015 RF

Art 20002 NR / 2x Art 20015 NG / 1x Art 20015 RF



Art 20001 BB / 3 x 20012 AN



Art 20002 BB / 3 x 20013 BB































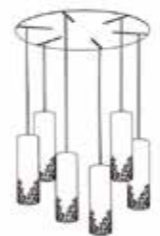

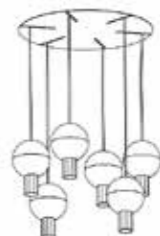







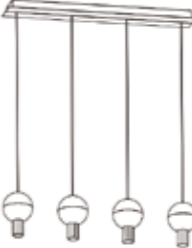



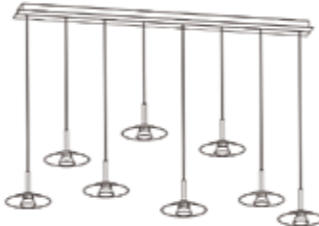

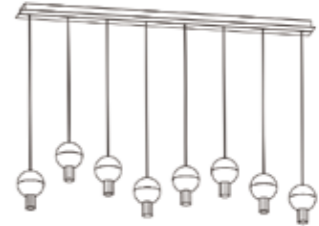

Art 20001 NR / 12 x 20014 RF



2 x Art 20004 NR / 2 x 20011 ON

	<p>OI NI AI</p>  <p>Art 20011</p>	<p>OI NI AI</p>  <p>Art 20012</p>	<p>BB  BZ  TN </p>  <p>Art 20013</p>	<p>LA  NG  OL  RF </p>  <p>Art 20014</p>	<p>LA  NG  OL  RF </p>  <p>Art 20015</p>
<p>BB  NR </p>  <p>Art 20001</p>	 <p>Max 6</p>	 <p>Max 6</p>	 <p>Max 6</p>	 <p>Max 12</p>	 <p>Max 6</p>
<p>BB  NR </p>  <p>Art 20002</p>	 <p>Max 4</p>	 <p>Max 4</p>	 <p>Max 4</p>	 <p>Max 8</p>	 <p>Max 4</p>
<p>BB  NR </p>  <p>Art 20003</p>	 <p>Max 8</p>	 <p>Max 8</p>	 <p>Max 8</p>	 <p>Max 16</p>	 <p>Max 8</p>
<p>BB  NR </p>  <p>Art 20004</p>					

20001

Rosone con alimentatore  
Ceiling box with power supply  
60 W

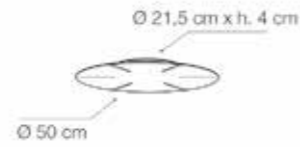

20002

Rosone con alimentatore  
Ceiling box with power supply  
25 W

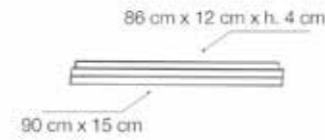

20003

Rosone con alimentatore  
Ceiling box with power supply  
60 W

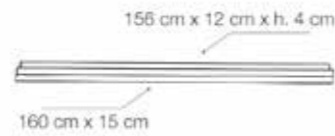

20004

Rosone con alimentatore  
Ceiling box with power supply  
6 W

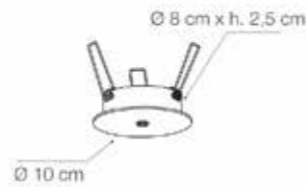

Structure	Dimmer	Led Light	Lens	IP	Diffuser
BB <input type="checkbox"/>	<b>D</b> (Dimmer)	<b>X</b>	<b>X</b> (No lens)	<b>X</b> (IP20)	<b>XX</b>
NR <input checked="" type="checkbox"/>					

20011

Light Source  
6 W  
850 Lumen  
CRI90

Structure Led Light

- ON  **H** 2700 K ●
- NR  **W** 3000 K ●
- AN  **N** 4000 K ●

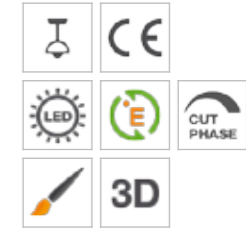
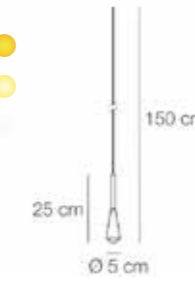

20012

Light Source  
6 W  
850 Lumen  
CRI90

Structure Led Light

- ON  **H** 2700 K ●
- NR  **W** 3000 K ●
- AN  **N** 4000 K ●

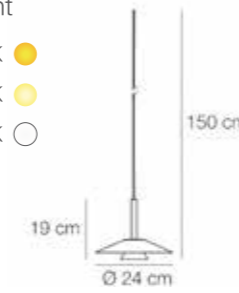

20013

Light Source  
6 W  
850 Lumen  
CRI90

Structure Led Light

- BB  **H** 2700 K ●
- BZ  **W** 3000 K ●
- TN  **N** 4000 K ●

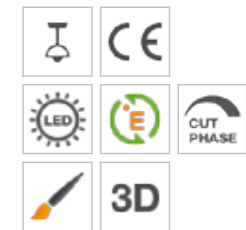
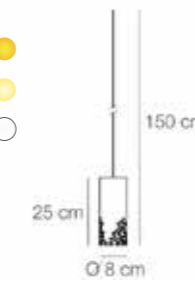

20014

Light Source  
3 W  
430 Lumen  
CRI90

Structure Led Light

- LA  **H** 2700 K ●
- NG  **W** 3000 K ●
- OL  **N** 4000 K ●
- RF

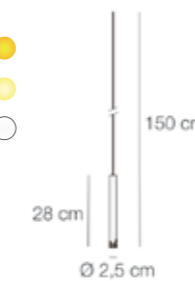

20015

Light Source  
6 W  
850 Lumen  
CRI90

Structure Led Light

- LA  **H** 2700 K ●
- NG  **W** 3000 K ●
- OL  **N** 4000 K ●
- RF

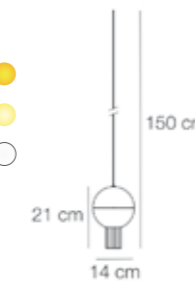



Creative Direction: Elesi Creative Lab  
Graphic Designer: Simone Guerretta  
Images: Studio Pointer, Bruger Studio, Mind@ware, Fisheye comunicazione

Print: Logo srl

Questo catalogo è stato stampato con inchiostri  
a base vegetale su carta certificata FSC.

*This catalog was printed with plant-based inks on FSC  
certified paper.*

**Elesi Luce**

Via Magellano, 8 - 35010  
Trebasseghe (PD) / Italy

**info@elesiluce.it**  
t. +39 049 9385235



**www.elesiluce.it**

I dati riportati in questo catalogo sono indicativi e non costituiscono impegno da parte di Elesi Luce srl che si riserva il diritto di apportare tutte le modifiche e migliorie necessarie senza obbligo di preavviso. Il presente catalogo ha durata pluriennale, i dati tecnici possono subire cambiamenti che verranno aggiornati sul sito [www.elesiluce.it](http://www.elesiluce.it).

*All data in this catalog are generic and do not constitute a commitment on the part of Elesi Luce srl which reserves the right to make all necessary changes and improvements without prior notice. This catalog will last of several years, the technical data may undergo changes which will be updated on the website [www.elesiluce.it](http://www.elesiluce.it).*

Seguici su:

