

Space saving



| | | | |
|-------|---|------------|-----|
| Index | Tavoli-consolle / Console-Tables | Supremae | 06 |
| | | Ulisse | 14 |
| | | City | 22 |
| | | Hermes | 30 |
| | | Excel | 38 |
| | | Leonardo | 46 |
| | | Marvel | 54 |
| | | Archimede | 64 |
| | Tavoli-scrivanie chiudibili / Folding desk-tables | Bureau | 76 |
| | | Plana | 84 |
| | Sedie chiudibili / Folding chairs | Piper | 90 |
| | | Zeta | 96 |
| | Tavolini / Coffee-tables | Brighton | 106 |
| | | London | 108 |
| | Specchi guardaroba / Wardrobe mirrors | Hide | 110 |
| | | Slide | 116 |
| | | Angolo | 122 |
| | | Rettangolo | 128 |
| | Carrelli chiudibili / Folding carts | Select | 134 |

Crediamo nell'importanza di progettare uno spazio dinamico adattabile al proprio modo di abitare.

Dal 1974

Realizziamo soluzioni modulari e mobili trasformabili per uno spazio in cui vivere, giocare e lavorare meglio. Le nostre sedie, i nostri tavoli e i complementi d'arredo sono progettati in Italia ma pensati per le case in tutto il mondo.

Estetica e Funzionalità: una casa in cui il movimento è naturale e libero ci permette di vivere meglio. Crediamo nell'importanza di progettare uno spazio dinamico adattabile al proprio modo di abitare. Per questo mettiamo passione e dedizione nella ricerca di innovative soluzioni salva spazio e prodotti modulari e riconfigurabili. Le nostre idee e quelle dei designer che collaborano con noi, danno vita a forme e funzioni originali realizzate con nuovi materiali e finiture.

Passione per la casa: siamo alla terza generazione di un'azienda familiare che, dalla sua fondazione nel 1974, non ha mai smesso di crescere. Partendo dalla produzione artigianale siamo (diventati) oggi un brand di design internazionale. Da sempre mettiamo le persone al centro del nostro lavoro e quello che non è cambiato, negli anni, è la nostra passione per la casa e per gli infiniti modi di viverla.

Since 1974

We create modular and portable solutions to shape up the spaces you live in, work and play. Our collections of chairs, tables and many different interior furnishings are designed in Italy, but made to fit homes worldwide.

Aesthetics and Functionality: a house where you can move freely enables you to live better. We firmly believe in the importance of creating a dynamic and fit to the purpose living space. That is why we are passionate about the creation of ever innovative space-saving and modular solutions. Our ideas, and those of the collaborating designers, constantly inspire elements of new shape and functions with peculiar materials and superb finishes.

Passion for homes: we are a third generation family owned business that has significantly developed since its establishment in 1974, elevating the originally handmade production to the international design brand status. The uniqueness and devotion to the people have remained the focus of our work over the years, just like our heartfelt passion for home and the endless possibilities of living it will never change.

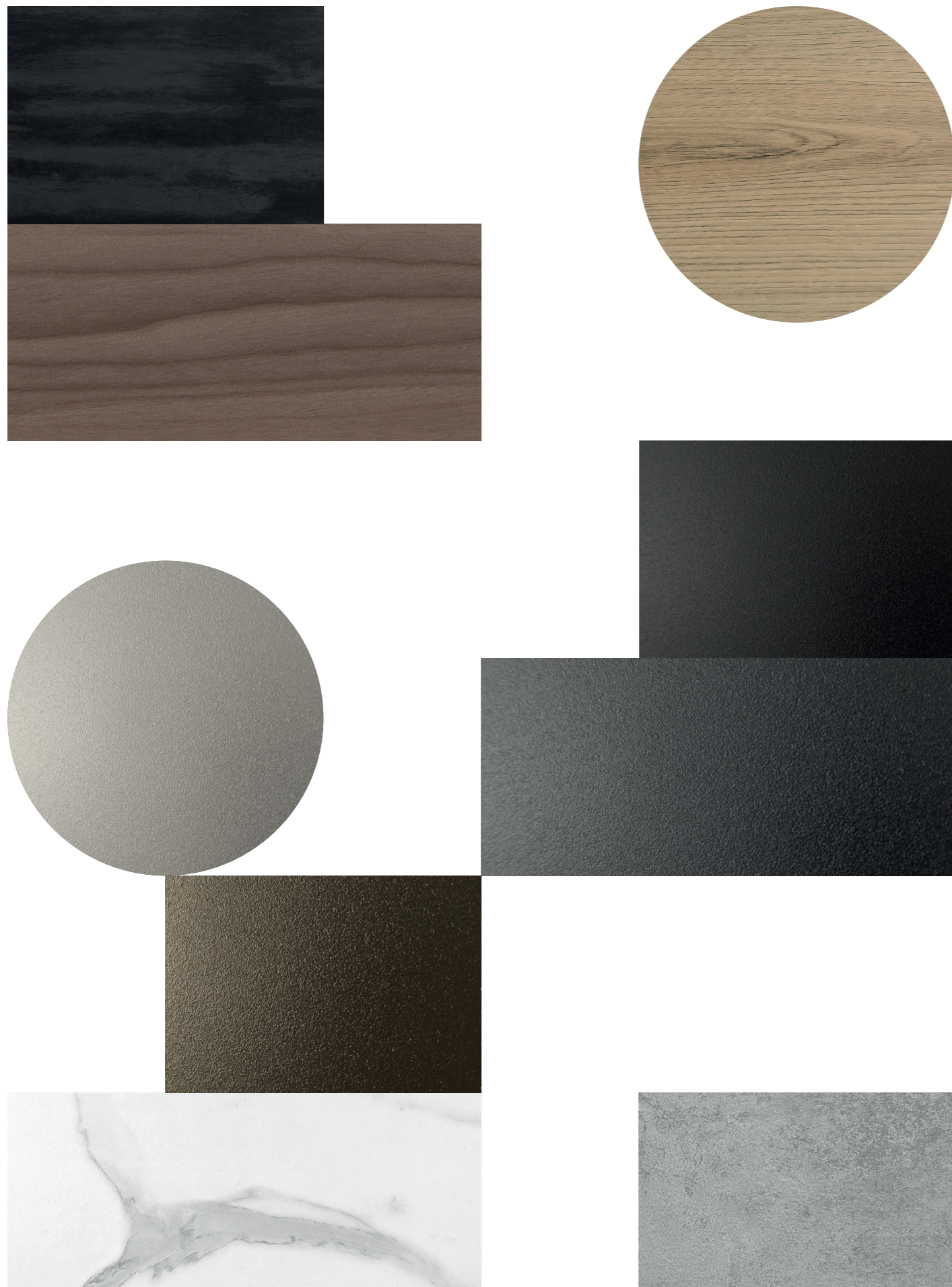

Molteplici colori

I colori giocano un ruolo fondamentale nel modo di arredare e vivere la casa. Trovare il giusto abbinamento è importante da un punto di vista estetico, ma un'adeguata scelta dei colori favorisce il nostro benessere e condiziona il nostro stato d'animo. In questa collezione proponiamo una selezione di finiture e colori armoniosi dalle tonalità tenui per creare ambienti confortevoli.

La nostra palette parte dal nero per arrivare fino al bianco assoluto, attraverso una serie di sfumature che si combinano fra loro. Trovate finiture opache e morbide come il laccato, finiture materiche di tendenza, finiture che riproducono essenze pregiate e marmo. Il tutto si abbina armoniosamente ai riflessi di luce del metallo verniciato a caldo con effetto sablé, dando origine ad innumerevoli possibili combinazioni di colori, in grado di soddisfare qualsiasi esigenza.

Several combinations

Colours play an essential role in the way we furnish and live in our homes. Finding the right combination is important from an aesthetic point of view, but the right choice of colours also influences our sense of well-being and mood. In this collection, we offer a selection of harmonious finishes and colours in soft tones to create comfortable environments.

Our palette starts with black and goes all the way through to pure white. It also offers a series of shades that complement each other. Matte and soft finishes, textured finishes, finishes reproducing precious woods and marble. All of this is harmoniously combined with the light reflections of the hot-painted metal with sablé effect, resulting in countless possible colour combinations to meet our needs.

Supremae



Ita Tavolo-Consolle allungabile con struttura in acciaio verniciato sablé e top in laminato ecologico con lavorazione folding. Il tavolo viene fornito completo di 2 o 3 allunghe da cm 42 cadauna. Due allunghe trovano alloggiamento in un contenitore all'interno della struttura, la terza deve essere conservata a parte.

En Table-console with extensions. Structure made of sandblasted colored steel and top made of Eco-friendly laminate manufactured with folding process. The table is supplied with 2 or 3 extensions (42 cm each). Two extensions can be placed into their case inside the structure, while the third one should be stored separately.

Dimensioni / Size

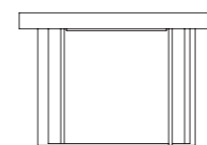

0/430 Chiuso / Closed
110 × 50 × h 75 cm

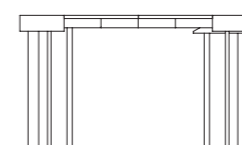
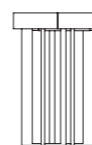

Aperto (2 allunghe) / Open (2 extensions)
110 × 134 × h 75 cm

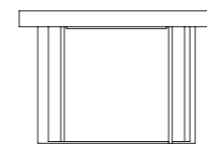
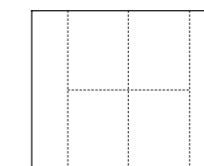

0/430.L Chiuso / Closed
110 × 50 × h 75 cm

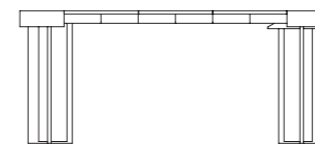
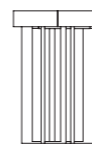

Aperto (3 allunghe) / Open (3 extensions)
110 × 176 × h 75 cm

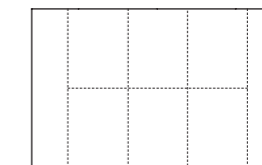





0/430 Aperto (2 allunghe) / Open (2 extensions)



0/430 - Rovere naturale + Nero sablé - Aperto (2 allunghe)
/ Natural oak + Sandblasted black - Open (2 extensions)
110 × 134 × h 75 cm



0/430 Chiuso / Closed
110 × 50 × h 75 cm



0/430.L Chiuso / Closed
110 × 50 × h 75 cm



1



2

Caratteristiche principali / Main features

1

All'interno del top è stato alloggiato un contenitore che contiene 2 allunghe che si piegano a libro. E' possibile aggiungere una terza allunga, identica alle altre, che però deve essere conservata a parte in un'apposita sacca dalle dimensioni contenute cm 43 x 56 x 4.

Inside the top there is a box that contains 2 extensions, with double leaf closing. It is possible to have an additional extension (42 cm) that should be stored separately in its small size bag cm 43 x 56 x 4.

2

La guida estensibile in alluminio in dotazione porta fino a 3 allunghe in entrambi i modelli ed il tavolo anche aperto alla massima estensione non necessita di gambe di sostegno ausiliarie.

The supplied aluminium extension slide is suitable for up to 3 extensions in both models. Moreover, even when table is open with maximum extension, no additional supporting legs are required.

3

Dettaglio del top realizzato in laminato ecologico cemento con lavorazione folding (misura 90 mm sul bordo esterno), e della gamba in acciaio verniciata nero sablé.

Detail of concrete Eco-friendly laminate top manufactured with folding process (with external board 90 mm) and of black sandblasted painted leg.



3

2 allunghe / extensions

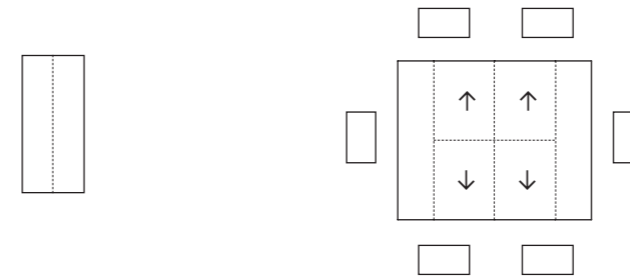

Chiuso/ Closed
50 cm larghezza / width

2 allunghe / extensions
6 posti / seats

3 allunghe / extensions

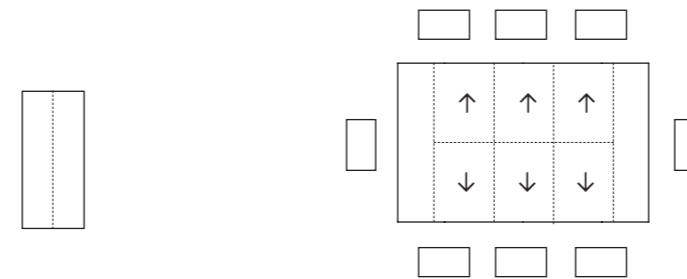

Chiuso/ Closed
50 cm larghezza / width

3 allunghe / extensions
8 posti / seats



Scansiona il QR code e scopri come funziona l'apertura / Scan the QR code and discover how it works

Finiture / Finishes



Colori e combinazioni disponibili nella web app Pezzani
Colors and combinations available in Pezzani's web app

Supremae



Ulisse

Ita Tavolo-Consolle allungabile con struttura in lamina d'acciaio verniciata sablé. Top in laminato ecologico spessore 18 mm. Il tavolo viene fornito completo di 4 allunghe (cm 60 cadauna) che trovano alloggiamento all'interno della struttura e diventano il fondo della consolle integrandosi perfettamente nella struttura. La guida estensibile è in alluminio. Le gambe pieghevoli di sostegno sono in acciaio inox.

En Table-console with extensions. This table-console is supplied with 4 extensions (60 cm each) which take place into the structure. Extensions become the back of the console by perfectly integrating with the structure. Structure made of sandblasted colored steel foil. Top made of Eco-friendly laminate 18 mm thick. The extension slide is made of aluminium and supporting folding legs are made of stainless steel.

Dimensioni / Size



0/415 - Chiuso / Closed
cm 90 × 45 × h 75

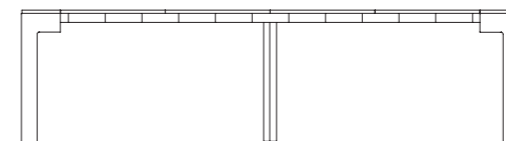
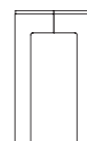

Apertura massima / Max extension
cm 285 (45 + 4 × 60) × 90 × h 75

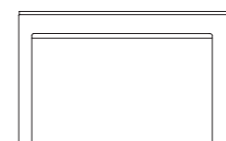
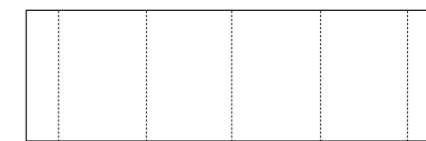

0/416 - Chiuso / Closed
cm 120 × 45 × h 75

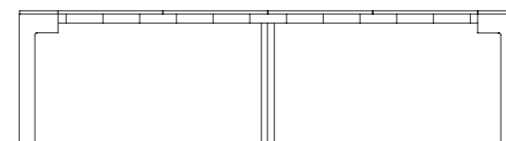
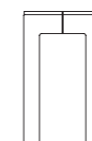

Apertura massima / Max extension
cm 285 (45 + 4 × 60) × 120 × h 75

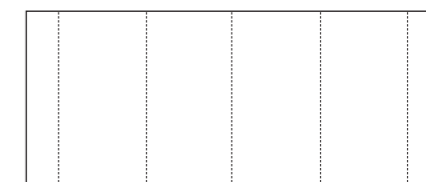





0/416 - Rovere naturale + Bronzo sablé
/ Natural oak + Sandblasted bronze



0/415 - Bianco + Bianco sablé
/ White + Sandblasted white



0/416 - Rovere naturale + Bronzo sablé
/ Natural oak + Sandblasted bronze

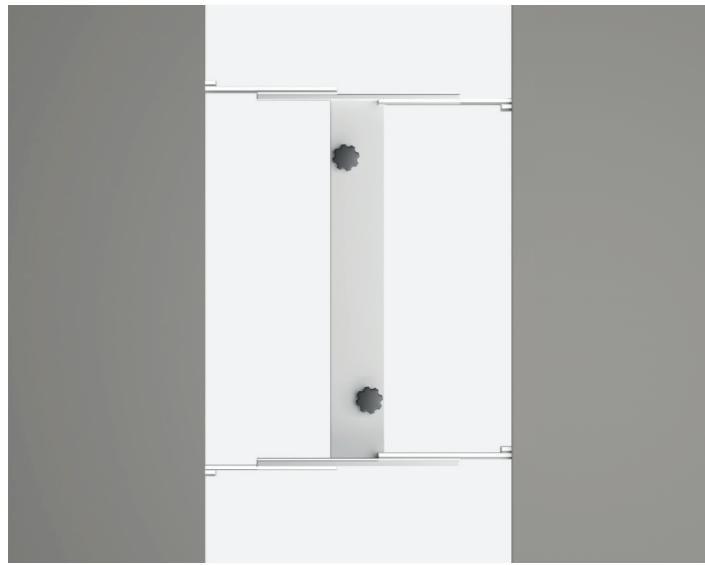

1



2



3

Caratteristiche principali / Main features

1

La guida estensibile è in alluminio. Le gambe pieghevoli di sostegno sono in acciaio inox.

The extension slide is made of aluminium and supporting folding legs are made of stainless steel.

2

Il tavolo viene fornito completo di 4 allunghe (cm 60 cadauna) che trovano alloggiamento all'interno della struttura e diventano il fondo della consolle integrandosi perfettamente nella struttura. Il sistema di aggancio e sgancio delle allunghe, quando le inseriamo nella struttura, è estremamente pratico e sicuro (vedi video).

This table-console is supplied with 4 extensions (60 cm each) which take place into the structure and become the back of the console. The extensions lock and unlock system, to store them inside the structure, is very practical and safe (see the video).

3

Dettaglio del top in laminato ecologico spessore 18 mm nero carbone e della gamba in acciaio verniciata nero sablé.

Detail of carbon black Eco-friendly laminate top 18 mm thick and of black sandblasted painted leg.

90 cm larghezza / width

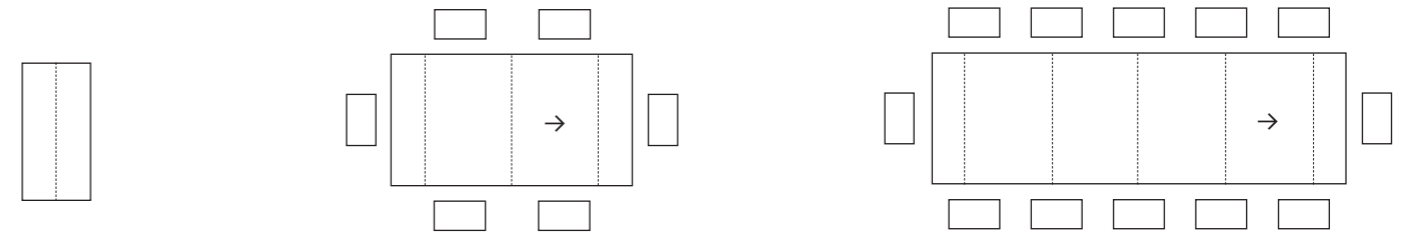

Chiuso/ Closed
45 cm larghezza / width

2 allunghe / extensions
6 posti / seats

4 allunghe / extensions
10 posti / seats

120 cm larghezza / width

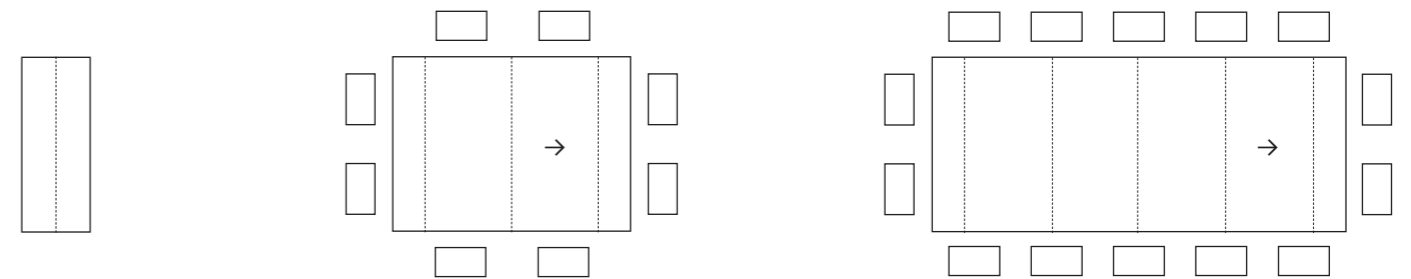

Chiuso/ Closed
45 cm larghezza / width

2 allunghe / extensions
8 posti / seats

4 allunghe / extensions
12 posti / seats



Scansiona il QR code e scopri come funziona l'apertura / Scan the QR code and discover how it works

Finiture / Finishes



Colori e combinazioni disponibili nella web app Pezzani
Colors and combinations available in Pezzani's web app



City

Ita Tavolo-Consolle allungabile con struttura e allunghe in laminato Ecologico da 18 mm. I fianchi portanti in vetro temperato spessore 10 mm grigio fumé o trasparente, rendono leggero ed elegante il tavolo. La guida estensibile è in alluminio. Le gambe pieghevoli di sostegno sono in acciaio inox.

En Table-Console with extensions. Structure and extensions made of Eco-friendly laminate 18 mm thick. Glass sides made of toughened clear or smoked grey glass 10 mm thick, make this table elegant with its lightweight design. The extension slide is made of aluminium and supporting folding legs are made of stainless steel.

Dimensioni / Size

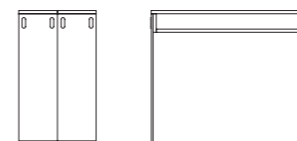

0/410 - Chiuso / Closed
cm 90 x 45 x h 75

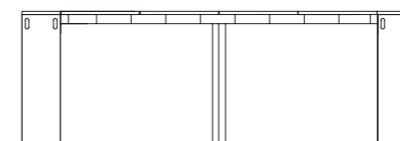

Apertura massima / Max extension
cm 225 (45 + 4 x 45) x 90 x h 75

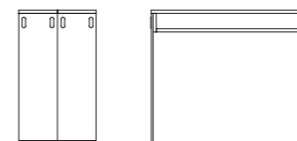
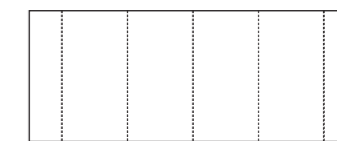

0/410.L - Chiuso / Closed
cm 90 x 45 x h 75

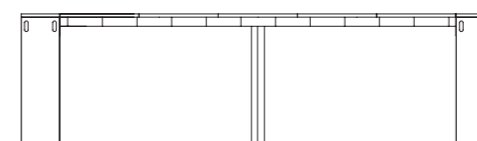

Apertura massima / Max extension
cm 270 (45 + 5 x 45) x 90 x h 75

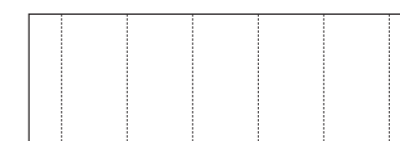





0/410 - Bianco + Vetro trasparente
/ White + Clear glass



0/410 - Bianco + Vetro trasparente
/ White + Clear glass



0/410 - Cemento + Vetro fumé
/ Concrete + Smoked glass

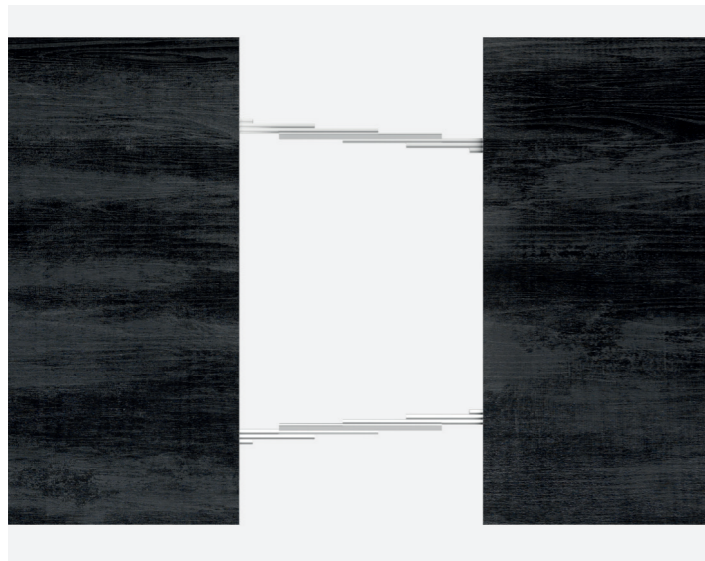

1



2

Caratteristiche principali / Main features

1

La guida estensibile in alluminio e le gambe pieghevoli di sostegno sono nascoste all'interno della struttura in laminato. Per riporre le allunghe sono disponibili due borse porta allunghe opzionali.

Aluminium extension slide and supporting stainless steel folding legs are hidden inside laminate structure. Two bags to store extensions are available (optional).

2

Dettaglio della piastra di fissaggio dei vetri alla struttura, realizzata in acciaio inox. Il nostro sistema a 2 punti di fissaggio per ogni piastra, garantisce il fissaggio forte e sicuro dei vetri temperati alla struttura.

Detail of the stainless steel plate that fixes toughened glass to the structure. Our fixing system with 2 points on each plate, assures a strong and safe glass fixing to the structure.

3

Dettaglio della gamba in vetro grigio fumé che rende il tavolo leggero ed elegante.

Detail of the smoked grey glass leg that makes the table even more elegant.



3

4 allunghe / extensions

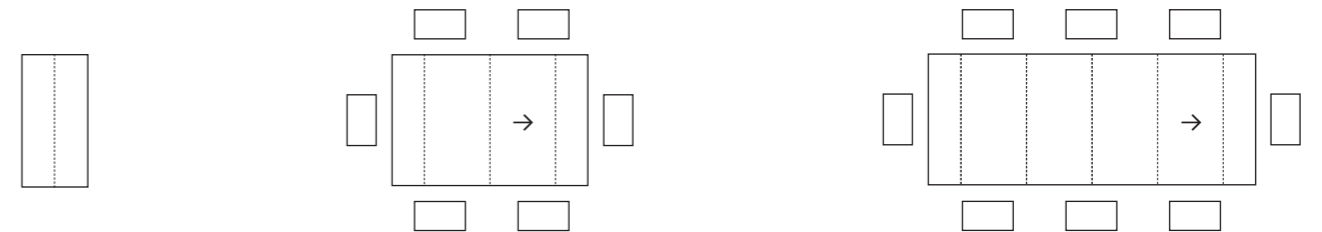

Chiuso/ Closed
45 cm larghezza / width

2 allunghe / extensions
6 posti / seats

4 allunghe / extensions
8 posti / seats

5 allunghe / extensions

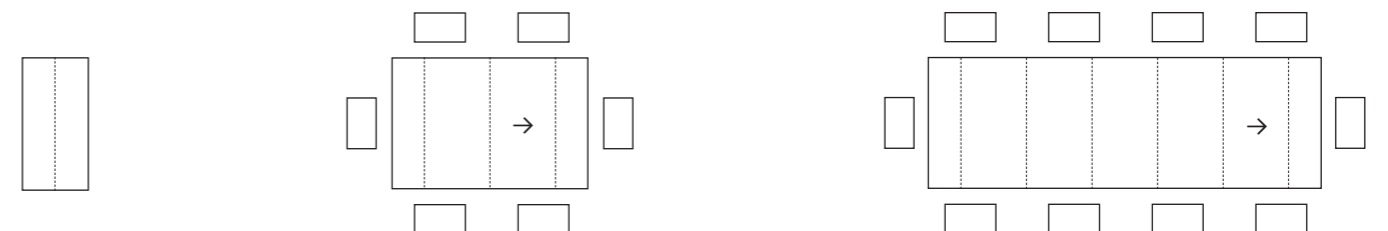

Chiuso/ Closed
45 cm larghezza / width

2 allunghe / extensions
6 posti / seats

5 allunghe / extensions
10 posti / seats



Scansiona il QR code e scopri come funziona l'apertura / Scan the QR code and discover how it works

Finiture / Finishes



Colori e combinazioni disponibili nella web app Pezzani
Colors and combinations available in Pezzani's web app



Hermés

Design: Pezzani

Ita Tavolo-Consolle trasformabile con apertura a libro del top in laminato ecologico spessore 18 mm. La struttura è composta da 2 gambe girevoli realizzate in acciaio tondo pieno Ø 12 mm verniciato con finitura sablé.

En Table-Console with double leaf opening top made of eco-friendly laminate 18 mm thick. The structure is made of 2 turning legs made of steel rods Ø 12 mm colored with sandblasted finishing.

Dimensioni / Size



0/439 - Chiuso / Closed
cm 115 × 45 × h 77

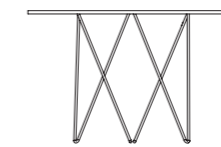

Aperto / Open
cm 115 × 90 × h 75

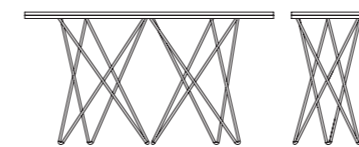

0/441 - Chiuso / Closed
cm 140 × 40 × h 77

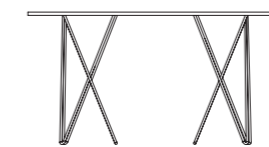

Aperto / Open
cm 140 × 80 × h 75

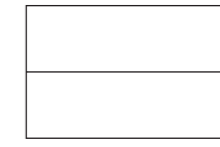





0/441 - Cemento + Grigio ardesia sablé
/ Concrete + Sandblasted ardesia grey



0/441 - Cemento + Grigio ardesia sablé
/ Concrete + Sandblasted ardesia grey



0/439 - Grigio tortora + Grigio tortora sablé
/ Dove grey + Sandblasted dove grey



1



2

Caratteristiche principali / Main features

1

Originale l'apertura a libro del top che consente di trasformare la consolle in tavolo in pochi secondi.

Thanks to the original double leaf opening, you can turn this console into a table in a few seconds.

2

La rotazione a compasso delle gambe garantisce un solido supporto al ripiano aperto e le sposta in posizione centrale, lasciando spazio alle gambe dei commensali che siederanno attorno al tavolo.

Legs rotation assure a strong support to the open top and moves legs to a central position, leaving more place for legs of the guests sitting around the table.

3

Dettaglio del top in laminato con finitura nero carbone e della gamba realizzata in tondo pieno ø 12 mm verniciata con finitura nero sablé.

Detail of carbon black laminate top and of the black sandblasted painted leg, made of steel rods ø 12 mm.



3

115 cm larghezza / width

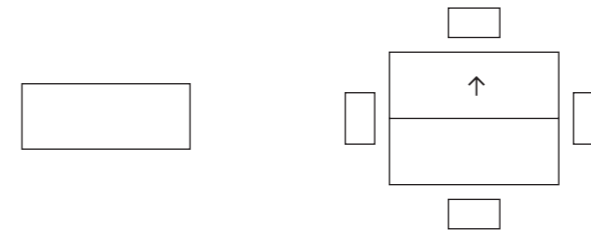

Chiuso/ Closed
115 cm larghezza / width

Aperto / Open
4 posti / seats

140 cm larghezza / width

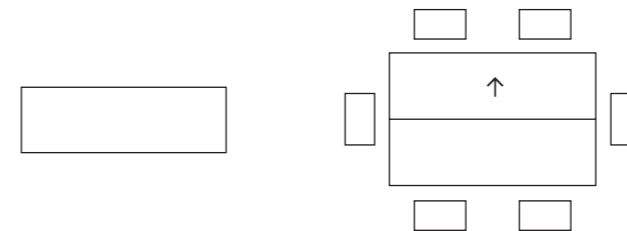

Chiuso/ Closed
140 cm larghezza / width

Aperto / Open
6 posti / seats



Scansiona il QR code e scopri come funziona l'apertura / Scan the QR code and discover how it works

Finiture / Finishes



Colori e combinazioni disponibili nella web app Pezzani
Colors and combinations available in Pezzani's web app



Excel

Design: Pezzani

Ita Tavolo-Consolle allungabile con struttura in lamina d'acciaio e gambe in acciaio tondo pieno da 12 mm verniciate con finitura sablé. Il top e le 5 allunghe in dotazione (da cm 45 cadauna) sono realizzati in laminato ecologico spessore 18 mm. La guida estensibile è in alluminio. Le gambe pieghevoli di sostegno sono in acciaio inox.

En Table-Console with extensions. Structure made of sandblasted colored steel foil and legs of steel rods 12 mm. Top and 5 extensions (45 cm each), are made of eco-friendly laminate 18 mm thick. The extension slide is made of aluminium and supporting folding legs are made of stainless steel.

Dimensioni / Size

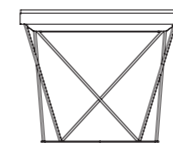

0/425 - Chiuso / Closed
cm 90 x 45 x h 75

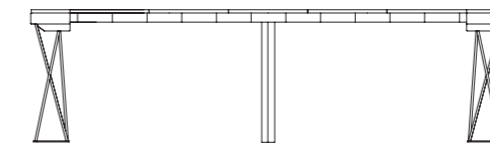

Apertura massima / Max extension
cm 270 (45 + 5 x 45) x 90 x h 75

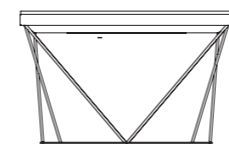
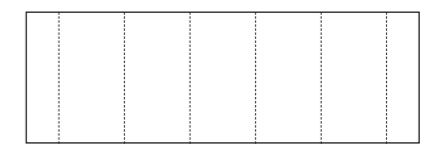

0/426 - Chiuso / Closed
cm 120 x 45 x h 75

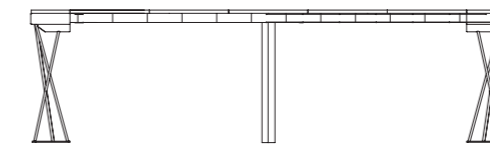

Apertura massima / Max extension
cm 270 (45 + 5 x 45) x 120 x h 75

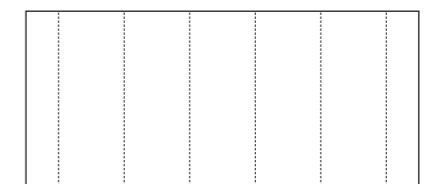





0/425 - Nero carbone + Nero sablé
/ Carbon black + Sandblasted black



0/425 - Nero carbone + Nero sablé
/ Carbon black + Sandblasted black



0/426 - Rovere naturale + Bronzo sablé
/ Natural oak + Sandblasted bronze

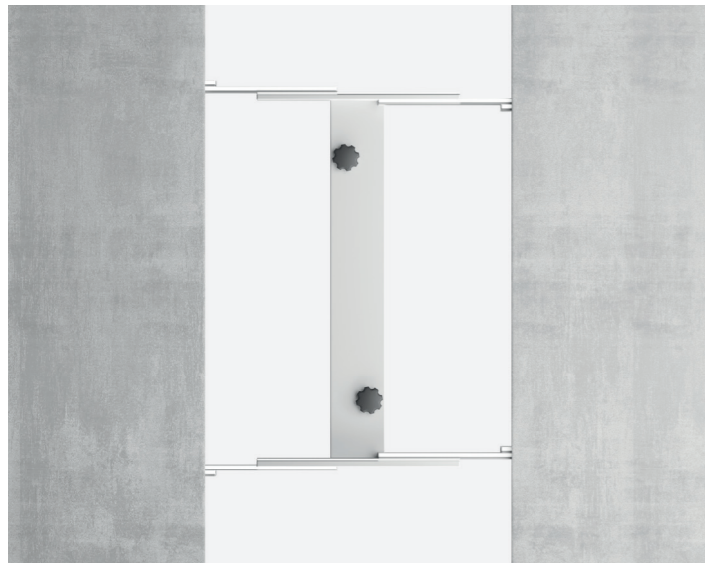

1

Caratteristiche principali / Main features

1 La guida estensibile in alluminio e le gambe pieghevoli di sostegno sono nascoste all'interno della struttura. Per riporre le allunghe sono disponibili due borse porta allunghe opzionali.

Aluminium extension slide and supporting stainless steel folding legs are hidden inside the structure. Two bags to store extensions are available (optional).

2 Dettaglio del top il laminato con finitura cemento e della gamba realizzata in lamina di acciaio e tondo pieno ø 12 mm verniciata con finitura grigio ardesia sablé.

Detail of concrete laminate top and of the ardesia grey sandblasted painted leg, made of steel foil and rods ø 12 mm.



2

90 cm larghezza / width

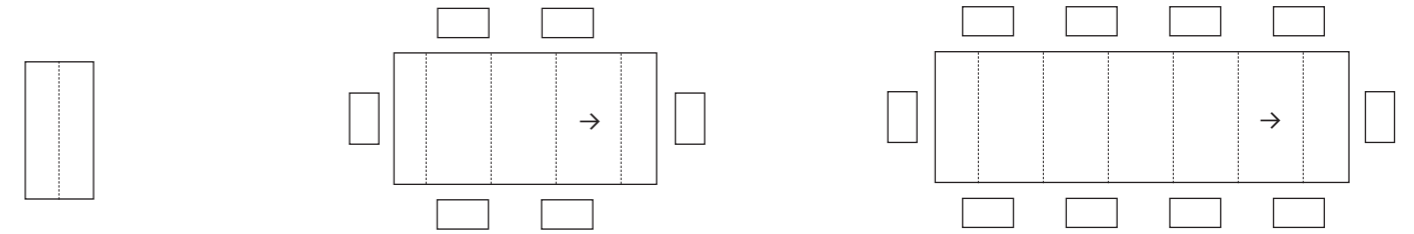

Chiuso/ Closed
45 cm larghezza / width

2 allunghe / extensions
6 posti / seats

4 allunghe / extensions
10 posti / seats

120 cm larghezza / width

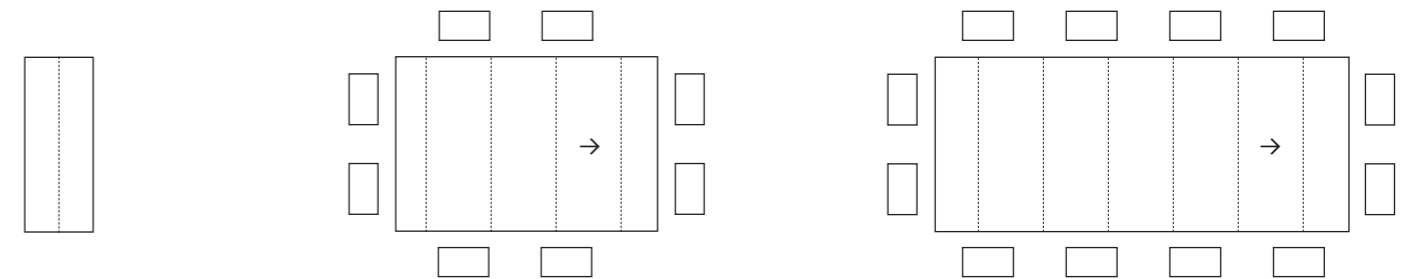

Chiuso/ Closed
45 cm larghezza / width

2 allunghe / extensions
8 posti / seats

4 allunghe / extensions
12 posti / seats



Scansiona il QR code e scopri come funziona l'apertura / Scan the QR code and discover how it works

Finiture / Finishes



Colori e combinazioni disponibili nella web app Pezzani
Colors and combinations available in Pezzani's web app

Leonardo



Ita Tavolo-Consolle allungabile con struttura in laminato ecologico spessore 25+18 mm rinforzata da una barra di alluminio sotto il top che è di 18 mm. Il tavolo è largo 90 o 120 cm e lungo 270 cm max quando vengono aggiunte le 5 allunghe (da 45 cm cadauna) in dotazione. La guida estensibile è in alluminio. Le gambe pieghevoli di sostegno sono in acciaio inox.

En Table-console with extensions. Structure made of Eco-friendly laminate 25+18 mm thick reinforced by an aluminum bar under the top 18 mm thick. The table is 90 or 120 cm wide and 270 cm long when all the 5 supplied extensions are added (cm 45 each). The extension slide is made of aluminium and supporting folding legs are made of stainless steel.

Dimensioni / Size



0/420 - Chiuso / Closed
cm 90 × 45 × h 75

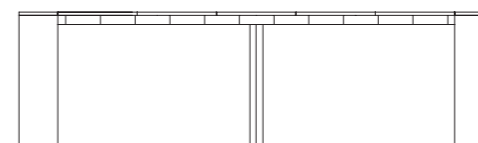

Apertura massima / Max extension
cm 270 (45 + 5 × 45) × 90 × h 75

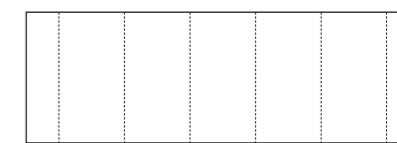

0/421 - Chiuso / Closed
cm 120 × 45 × h 75

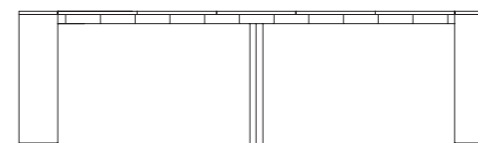

Apertura massima / Max extension
cm 270 (45 + 5 × 45) × 120 × h 75

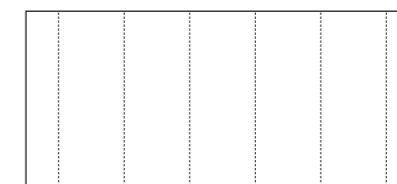





0/420 - Bianco + Grigio ardesia
/ White + Ardesia grey



0/420 - Bianco + Grigio ardesia
/ White + Ardesia grey



0/421 - Noce ardesia + Grigio ardesia
/ Ardesia walnut + Ardesia grey



1



3



2



Scansiona il QR code e scopri come funziona l'apertura / Scan the QR code and discover how it works

Caratteristiche principali / Main features

1

La guida estensibile in alluminio e le gambe pieghevoli di sostegno sono nascoste all'interno della struttura. Per riporre le allunghe sono disponibili due borse porta allunghe opzionali.

Aluminium extension slide and supporting stainless steel folding legs are hidden inside the structure. Two bags to store extensions are available (optional).

2

L'interno delle gambe è di colore Grigio Ardesia per creare un piacevole contrasto con la finitura del top disponibile in 8 colori. Tuttavia per i soli colori bianco, tortora e grigio ardesia è disponibile la versione monocromatica dove anche l'interno è coordinato al colore del top.

Inside part of legs is ardesia grey to obtain a nice contrast with top finishing (available in 8 colors). Only for white, dove grey and ardesia grey is available the monochromatic version (inside and top of the same color).

3

Dettaglio del top in laminato con finitura rovere naturale combinato con il grigio ardesia all'interno della gamba.

Detail of natural oak laminate top combined with ardesia grey legs (inside).

90 cm larghezza / width

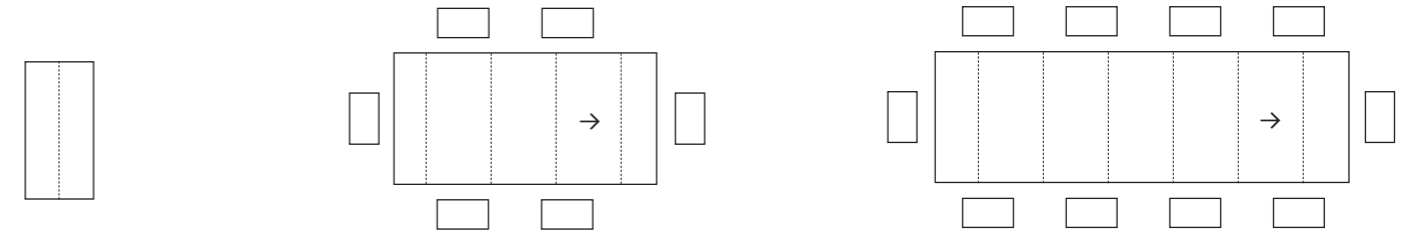

Chiuso/ Closed
45 cm larghezza / width

3 allunghe / extensions
6 posti / seats

5 allunghe / extensions
10 posti / seats

120 cm larghezza / width

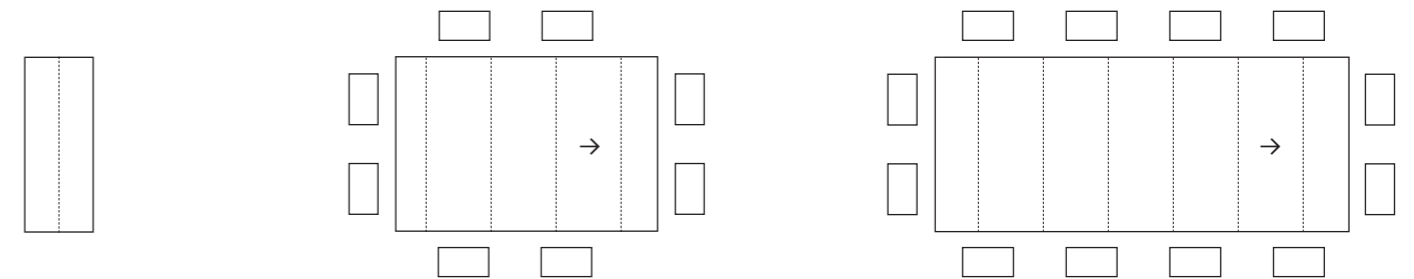

Chiuso/ Closed
45 cm larghezza / width

3 allunghe / extensions
8 posti / seats

5 allunghe / extensions
12 posti / seats

Finiture / Finishes



Colori e combinazioni disponibili nella web app Pezzani
Colors and combinations available in Pezzani's web app



Marvel

Ita Marvel è la prima consolle trasformabile in tavolo che contiene elegantemente le proprie allunghe. Il tavolo viene fornito completo di 4 allunghe (da cm 60 ciascuna) che trovano alloggiamento all'interno della struttura e diventano il fondo della consolle integrandosi perfettamente nella stessa. Ha la struttura in lamina d'acciaio verniciata con finitura sablé ed il top in laminato ecologico spessore 18 mm. La guida estensibile è in alluminio. Le gambe pieghevoli di sostegno sono in acciaio inox.

En Marvel is the first table-console that elegantly contains its extensions. This table-console is supplied with 4 extensions (60 cm each) which take place into the structure. Extensions become the back of the console by perfectly integrating with the structure. The structure is made of sandblasted colored steel foil and the top is made of Eco-friendly laminate 18 mm thick. The extension slide is made of aluminium and supporting folding legs are made of stainless steel.

Dimensioni / Size

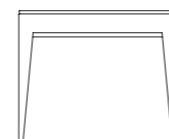

0/411 and 0/412 - Chiuso / Closed
cm 90 × 45 × h 75

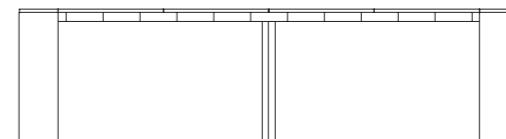

Apertura massima / Max extension
cm 285 (45 + 4 × 60) × 90 × h 75

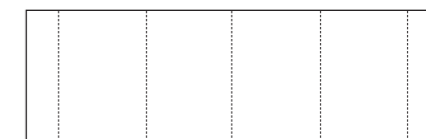

0/413 and 0/414 - Chiuso / Closed
cm 120 × 45 × h 75

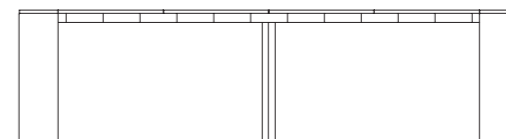

Apertura massima / Max extension
cm 285 (45 + 4 × 60) × 120 × h 75







0/411 - Cemento + Grigio ardesia sablé
/ Concrete + Sandblasted ardesia grey



0/411 - Cemento + Grigio ardesia sablé
/ Concrete + Sandblasted ardesia grey

0/413 - Marmo bianco fiorentino + Bianco sablé
/ Florentine white marble + Sandblasted white



Marvel+

Ita Nella versione + (plus), l'aggiunta di un sistema di aggancio consente di fissare una delle allunghe anche sul lato frontale della struttura. In questo modo la consolle si trasforma in un mobile contenitore dove poter riporre un carrello e 6/8 sedie chiudibili Piper o Zeta.

En In the + (plus) version, by adding a frontal hooking system for one of its extensions, the console will turn into a storage unit where you can put a chairs-holder and 6/8 Piper or Zeta folding chairs.



Scansiona il QR code e scopri come funziona / Scan the QR code and discover how it works

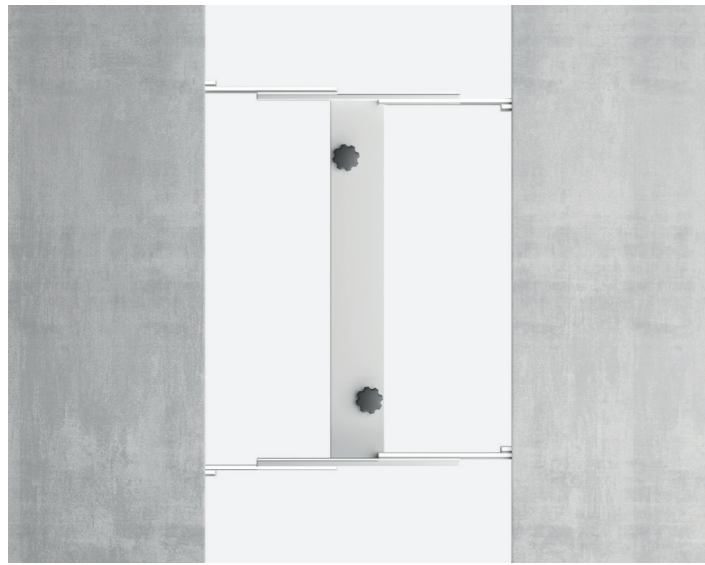

1

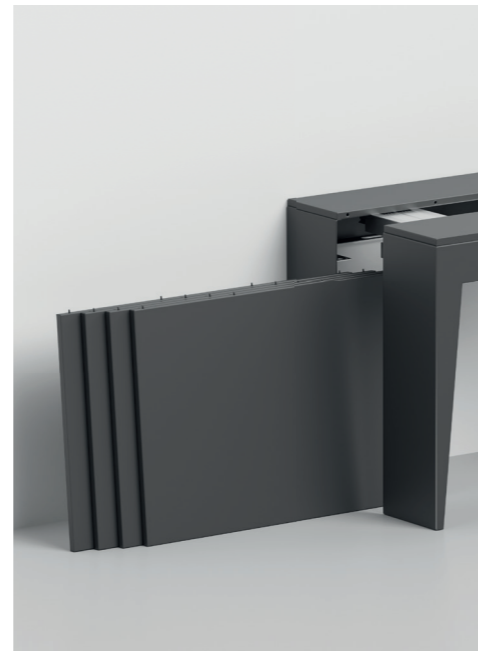

2



3

Caratteristiche principali / Main features

1

La guida estensibile è in alluminio. Le gambe pieghevoli di sostegno sono in acciaio inox.

The extension slide is made of aluminium and supporting folding legs are made of stainless steel.

2

Il tavolo viene fornito completo di 4 allunghe (cm 60 cadauna) che trovano alloggiamento all'interno della struttura e diventano il fondo della consolle integrandosi perfettamente nella struttura. Il sistema di aggancio e sgancio delle allunghe, quando le inseriamo nella struttura, è estremamente pratico e sicuro (vedi video).

This table-console is supplied with 4 extensions (60 cm each) which take place into the structure and become the back of the console integrating perfectly into the structure. The extension lock and unlock system, to store them inside the structure, is very practical and safe (see the video).

3

Dettaglio del top in laminato ecologico spessore 18 mm con finitura grigio ardesia e della gamba in acciaio verniciata grigio ardesia sablé.

Detail of ardesia grey top made of Eco-friendly laminate 18 mm thick combined with ardesia sandblasted painted leg.

90 cm larghezza / width

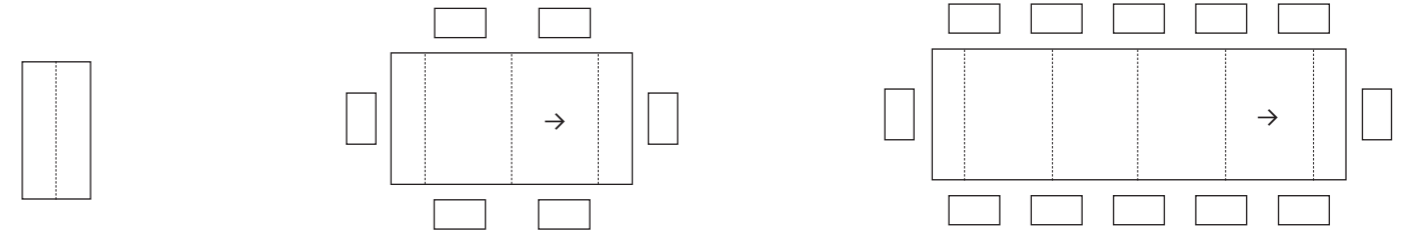

Chiuso/ Closed
45 cm larghezza / width

2 allunghe / extensions
6 posti / seats

4 allunghe / extensions
10 posti / seats

120 cm larghezza / width

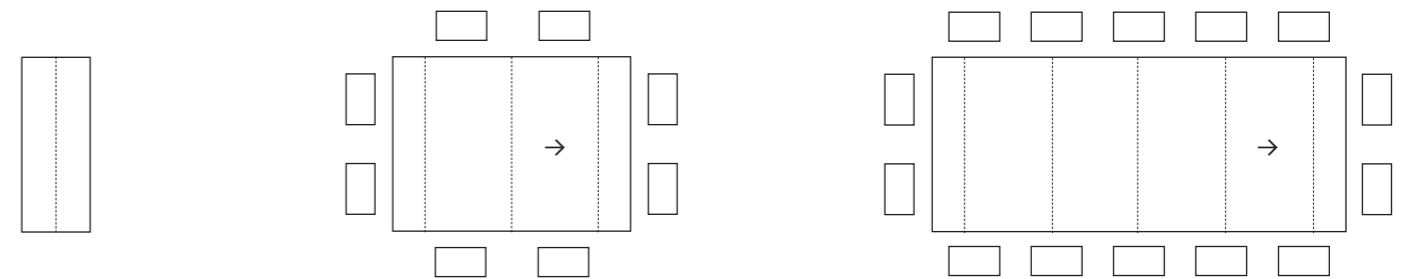

Chiuso/ Closed
45 cm larghezza / width

2 allunghe / extensions
8 posti / seats

4 allunghe / extensions
12 posti / seats



Scansiona il QR code e scopri come funziona l'apertura / Scan the QR code and discover how it works

Finiture / Finishes



Colori e combinazioni disponibili nella web app Pezzani
Colors and combinations available in Pezzani's web app

Archimede



Ita E' un sistema formato da un tavolo chiudibile (che contiene e nasconde fino a 6 sedie Zeta o Piper) e due mobili dedicati al suo contenimento, diversi per design e funzionalità. Questa versione del tavolo senza chiusure laterali ha la struttura in acciaio verniciato sablé ed il top in laminato ecologico da 18 mm.

En It's a clever system consisting of a folding table (containing 6 folding chairs Zeta or Piper) and two pieces of furniture with different design and features, conceived to contain this table. This version of the table without doors, has a sandblasted colored steel structure and Eco-friendly laminate top 18 mm thick.

Tavolo chiudibile (senza chiusure laterali) / Folding table (without doors)

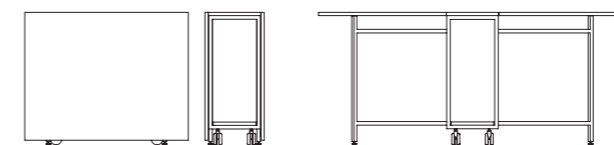

0/402 - Chiuso / Closed
cm 90 × 34 × h 73

Aperto / Open
cm 170 (34 + 2 × 68) × 90 × h 73

Consolle / Consoles



0/405
cm 96 × 36 × h 77

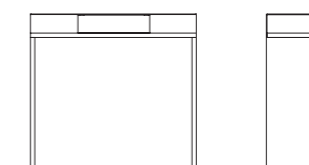

0/404
cm 96 × 36 × h 88





0/404.COMP-3 - tavolo Cemento + Nero sable con sedie Piper Bianche e consolle Cemento + Grigio ardesia sablé
/ Concrete + Sandblasted black table with White Piper chairs and Concrete + Sandblasted ardesia grey console



Il tavolo si apre anche a metà e lasciandolo inserito nel mobile sporge 68 cm dalla consolle
/ The half-opened folding table will extend 68 cm from the console



0/402 - tavolo Bianco + Bianco sable con sedie Piper Nere
/ White + Sandblasted white table with Black Piper chairs



0/405 - Consolle realizzata in laminato ecologico 12 mm (esterno) Bianco accoppiato al 18 mm (interno) di colore Grigio ardesia.
/ Console made of Eco-friendly White laminate 12 mm thick (outside) combined with Ardesia grey laminate 18 mm thick (inside).

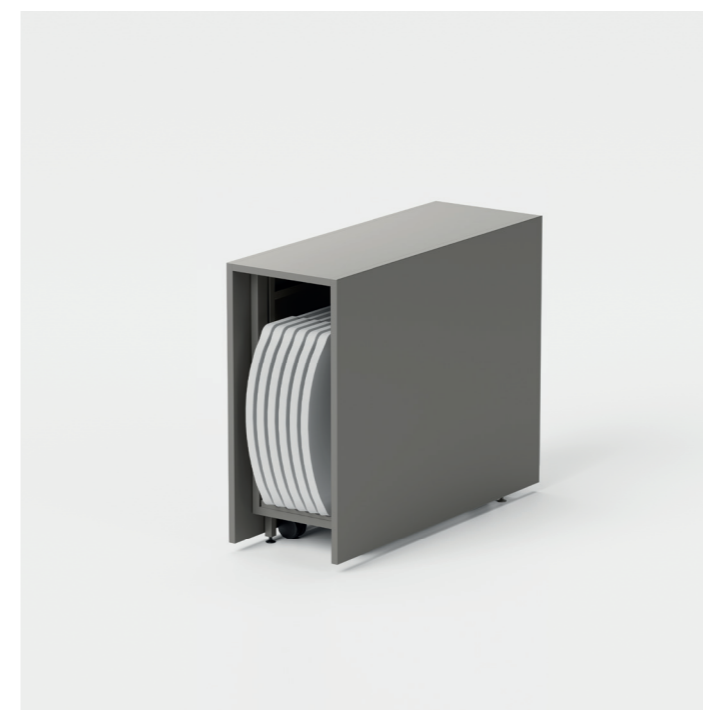

0/402 - tavolo Grigio tortora + Grigio tortora sable con sedie Zeta Bianche
/ Dove grey + Sandblasted dove grey table with White Zeta chairs



0/404 - Consolle con cassetto. Top in acciaio Bianco sablé, struttura in laminato ecologico Bianco da 25 mm.
/ Console with drawer. Top made of White sandblasted colored steel, structure made of White eco-friendly laminate 25 mm thick.



Archimede+

Ita Nella versione + (plus) il tavolo chiudibile viene fornito con l'aggiunta di chiusure laterali (una con sportello apribile), per nascondere le sedie pieghevoli Piper o Zeta contenute al suo interno quando il tavolo è chiuso. Le chiusure laterali sono integrate nella struttura e sono realizzate anch'esse in acciaio verniciato sablé.

En In the + (plus) version the folding table is supplied with side closing (one with door) to hide folding chairs Piper or Zeta contained into the table when closed. Sides closing, made of sandblasted colored steel, are integrated into table structure.



Scansiona il QR code e scopri come funziona / Scan the QR code and discover how it works



Caratteristiche principali / Main features

1 I due modelli di consolle abbinabili al tavolo pieghevole Archimede, sono indipendenti e rimangono nella loro posizione anche quando il tavolo è in uso. Non è necessario spostare soprammobili quando si ricevono ospiti. I colori della consolle e quello del top del tavolo pieghevole, si possono combinare a piacere scegliendo fra le finiture proposte nella nostra collezione.

Two different models of the console can be combined with folding table Archimede. Both of them are self-standing and stay in their position even when you are using the table. You do not have to move ornaments when you have guests. You can combine colors of console and top of folding table as you prefer, by choosing among the finishing of our collection.

Il sistema di apertura delle gambe chiudibili del tavolo è assistito da un movimento a gas che agevola l'apertura nella posizione corretta ed impedisce la chiusura accidentale della gamba in caso di urto.

The folding legs opening system is facilitated by gas motion that helps to open the table into the right position and prevent the accidental closing of the leg in case of impact.

Il tavolo si muove su robuste ruote in gomma morbida e si sposta agevolmente, mentre le gambe apribili hanno i piedini regolabili per stabilizzare il tavolo quando è in uso.

Table has solid and soft rubber castors and it is very easy to move, while on opening legs there are high-adjustable feet to stabilize the table when you use it.



Scansiona il QR code e scopri come funziona l'apertura / Scan the QR code and discover how it works

90 cm larghezza / width

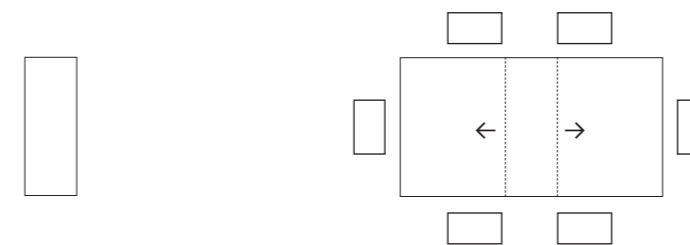

Chiuso / Closed
34 cm larghezza / width

Aperto / Open
6 posti / seats

Finiture / Finishes



Colori e combinazioni disponibili nella web app Pezzani
Colors and combinations available in Pezzani's web app

Bureau

Design: Pezzani

Ita Sistema composto da un mobile contenitore da parete (che si trasforma in tavolo/scrivania) e dalla libreria opzionale. Il mobile contenitore, realizzato in laminato Ecologico da 18 mm, ha l'anta di chiusura che diventa un solido piano d'appoggio, sostenuto da staffe in acciaio pieghevoli facilmente azionabili. Al suo interno può contenere fino a 3 sedie chiudibili Piper o Zeta. La libreria ha la struttura in acciaio verniciato con finitura sablé ed il ripiano in laminato Ecologico da 25 mm di spessore.

En This system is composed by a wall storage unit (that turns into a table/desk) and a bookcase (optional). The wall storage unit door, made of Eco-friendly laminate 18 mm thick, turns into a solid top, supported by steel folding brackets, easy to open and close. Inside it can hold Piper or Zeta folding chairs (maximum 3 pcs). Wall bookcase structure is made of sandblasted colored steel and shelves are made of Eco-friendly laminate 25 mm thick.





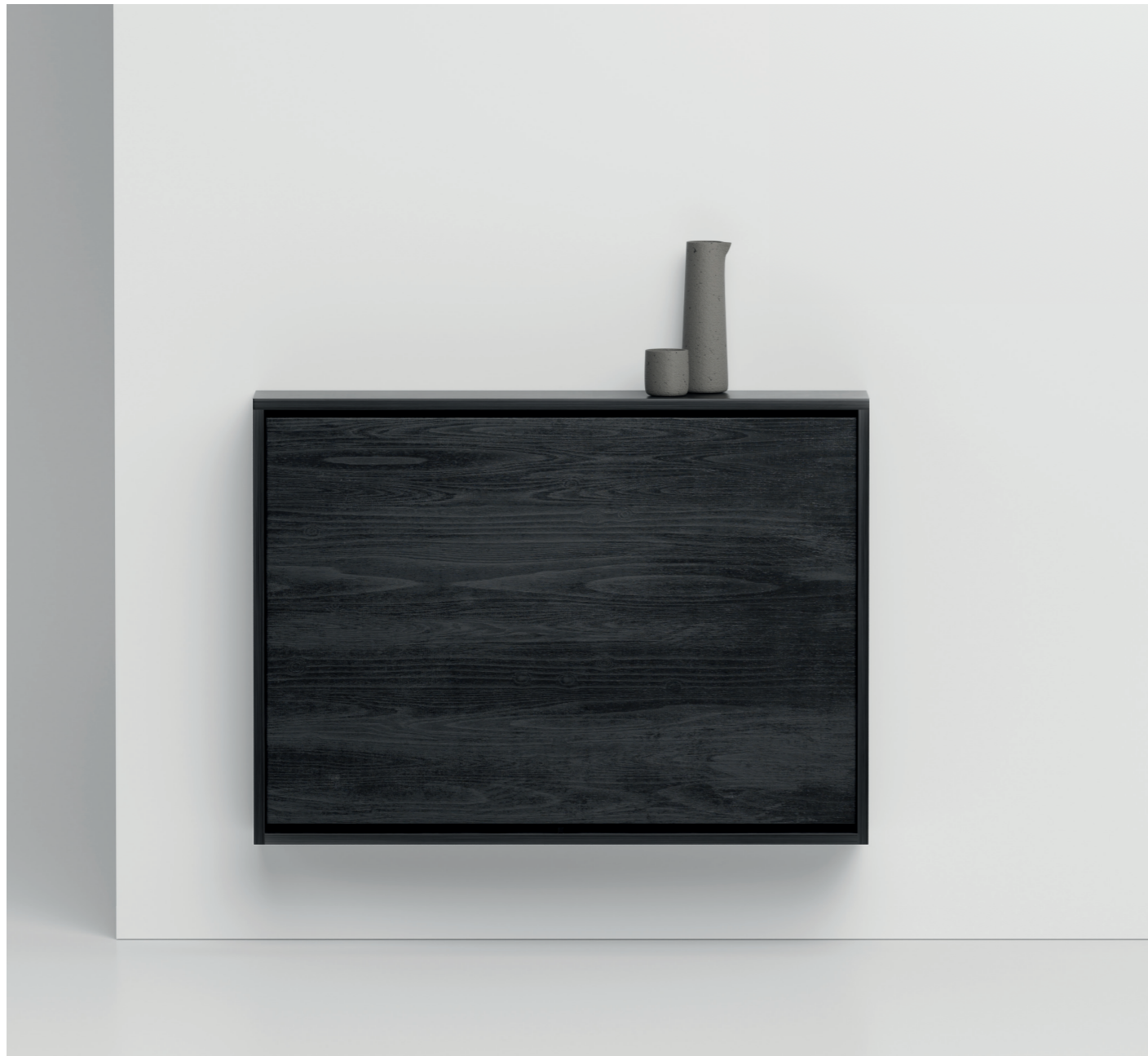



1



2

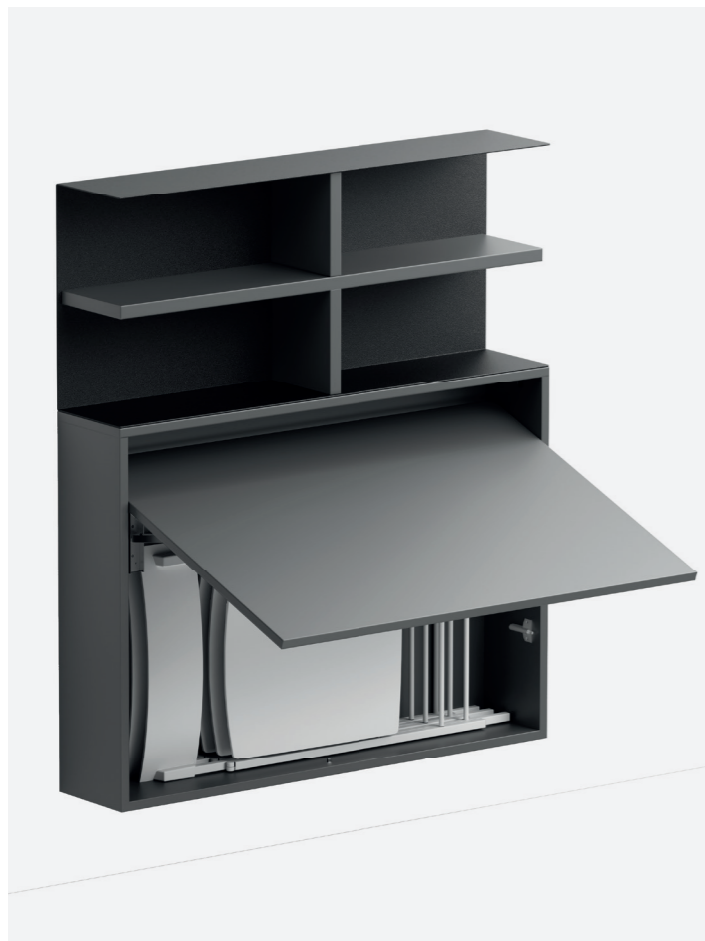

3

Caratteristiche principali / Main features

1

Le staffe di sostegno in acciaio sopportano il carico senza flessioni e si bloccano automaticamente in posizione aperta quando si solleva il ripiano. Il ripiano si sblocca altrettanto agevolmente, ma solo premendo contemporaneamente (per scongiurare la possibilità di sblocco accidentale) i pulsanti di sblocco presenti nelle 2 staffe di sostegno. La chiusura del ripiano è inoltre ammortizzata da pistoncini frenanti.

Steel folding brackets support the weight without bending and when you lift the top they automatically lock into open position. You can easily unlock the top only when you push the two unlock buttons on the two folding brackets at the same time (to avoid an accidental unlock). Moreover, two brake pistons cushion top closing.

2

Il mobile contenitore (0/87) che si trasforma in tavolo/scrivania e la libreria (0/67) sono vendibili separatamente.

Wall storage unit (0/87) that turns into a table/desk and bookcase (0/67) are sold separately.

3

L'ingombro da chiuso del mobile contenitore è di soli 20 cm di profondità, mentre da aperto l'ingombro è complessivamente di 70 cm. All'interno del contenitore trovano alloggio 3 sedie chiudibili Piper o Zeta.

Closed wall storage unit is only 20 cm deep, while when open total depth is 70 cm. Inside the storage unit you can put Piper or Zeta folding chairs (max 3 pcs).

Dimensioni / Size

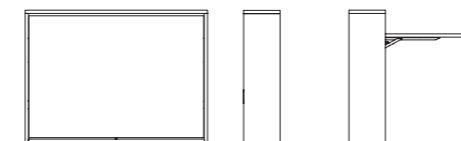

Chiuso / Closed
cm 100 × 20 × h 72

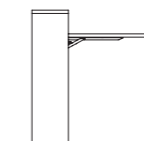

Aperto / Open
cm 100 × 70 × h 72

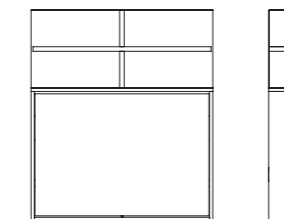

Chiuso / Closed
cm 100 × 20 × h 115

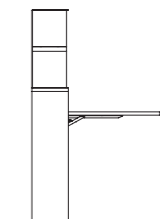

Aperto / Open
cm 100 × 70 × h 115



Scansiona il QR code e scopri come funziona l'apertura / Scan the QR code and discover how it works

Finiture / Finishes



Colori e combinazioni disponibili nella web app Pezzani
Colors and combinations available in Pezzani's web app

Plana

Design: Pezzani

Ita Tavolo/scrivania chiudibile da parete, con ripiano in alluminio da 4 mm (leggero, sottile e resistente) verniciato con le nostre finiture sablé combinato ad una solida struttura di sostegno chiudibile in acciaio verniciata in tinta.

En Wall folding table/desk. Top made of sandblasted colored aluminium 4 mm thick (light, thin and strong), combined with solid folding brackets made of colored steel.







1

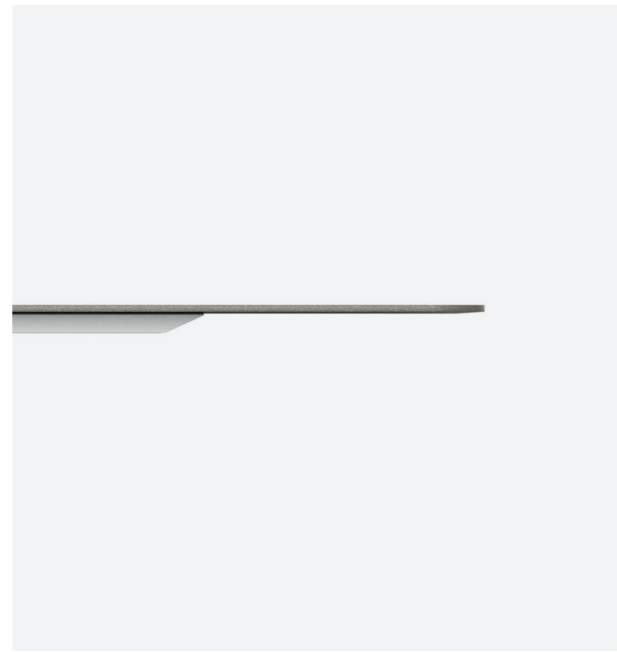

2



3

Caratteristiche principali / Main features

1

Le staffe di sostegno in acciaio sopportano il carico senza flessioni e si bloccano automaticamente in posizione aperta quando si solleva il ripiano. Il ripiano si sblocca altrettanto agevolmente ma solo premendo contemporaneamente (per scongiurare la possibilità di sblocco accidentale) i pulsanti di sblocco presenti nelle 2 staffe di sostegno.

Steel folding brackets support the weight without bending and when you lift the top they automatically lock into open position. You can easily unlock the top only when you push the two unlock buttons on the two folding brackets at the same time (to avoid an accidental unlock).

2

Il ripiano in alluminio di soli 4 mm di spessore è rigido e leggero da movimentare.

The 4 mm thick aluminium top is rigid and light to open and close.

3

La profondità ridotta a soli 2,5 cm (chiuso) lo rende uno dei tavoli chiudibili da parete più sottili al mondo, capace di confondersi con la parete di appoggio o di rivelare la sua forma a seconda della colorazione scelta.

Thanks to its depth (only 2,5 cm closed) is one of the thinner wall folding-table worldwide. Depending on chosen color, it blends with the wall or shows its shape.

Dimensioni / Size

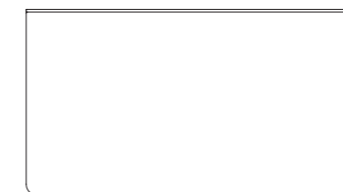

Chiuso / Closed
cm 90 × 2,5 × h 50

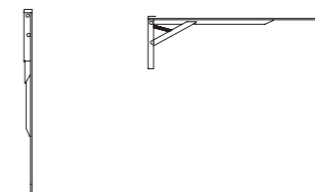

Aperto / Open
cm 90 × 51 × h 0,4



Scansiona il QR code e scopri come funziona l'apertura / Scan the QR code and discover how it works

Finiture / Finishes



Colori e combinazioni disponibili nella web app Pezzani
Colors and combinations available in Pezzani's web app

Plana

Piper

Design: Scutellà

Ita Questa sedia pieghevole di design ha una solida struttura in acciaio verniciato con finitura sablè. La seduta in polipropilene (PP) è costituita da 2 parti (cover e fondo) che avvolgono e nascondono al suo interno la struttura in acciaio. Lo schienale anch'esso in polipropilene ha uno spessore di 6 mm.

En This modern-design folding chair has a strong structure made of sandblasted colored steel. Seat is made of polypropylene (PP) and consists in two parts (top and cover) that wrap and hide the inside steel structure. Back is made of solid polypropylene 6 mm thick.



Scansiona il QR code e scopri come funziona l'apertura
/ Scan the QR code and discover how it works



Dimensioni / Size

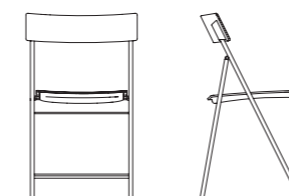

SE04 - Aperta / Open
cm 46 × 46 × h 79



Chiusa / Closed
cm 7,5 × 46 × h 90

Finiture / Finishes



Colori e combinazioni disponibili nella web app Pezzani
Colors and combinations available in Pezzani's web app





Chiusa è estremamente compatta e ne possiamo inserire tante in poco spazio, come nelle nostre consolle trasformabili.

When closed it is very thin and you can put several of them in a little space, as in our table-panels.



Zeta

Design: Pezzani

Ita Zeta è sicuramente una delle più compatte sedie pieghevoli attualmente in commercio. E' realizzata con una solida struttura in acciaio verniciato con finitura sablé combinata a confortevoli seduta e schienale in polipropilene (PP).

En Zeta is one of the most compact folding chairs on the market. It has a strong structure made of sandblasted colored steel and comfortable seat and back made of polypropylene (PP).



Scansiona il QR code e scopri come funziona l'apertura
/ Scan the QR code and discover how it works



Dimensioni / Size

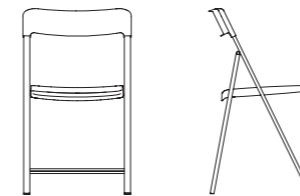

SE03 - Aperta / Open
cm 45,5 × 46 × h 78



Chiusa / Closed
cm 5 × 46 × h 89

Finiture / Finishes



Colori e combinazioni disponibili nella web app Pezzani
Colors and combinations available in Pezzani's web app





Chiusa è estremamente compatta e ne possiamo inserire tante in poco spazio, come nelle nostre consolle trasformabili.

When closed it is very thin and you can put several of them in a little space, as in our table-consols.



CS01

Design: Pezzani

Ita Pratico carrello porta-sedie, realizzato in acciaio verniciato. A pieno carico porta 8 sedie (Piper o Zeta). Il carrello è pieghevole e, quando non è in uso, può essere riposto in poco spazio.

En Practical chairs-holder cart made of colored steel, suitable for max 8 chairs Piper or Zeta. It is folding too and when not in use, you can store it in a little space.



Dimensioni / Size

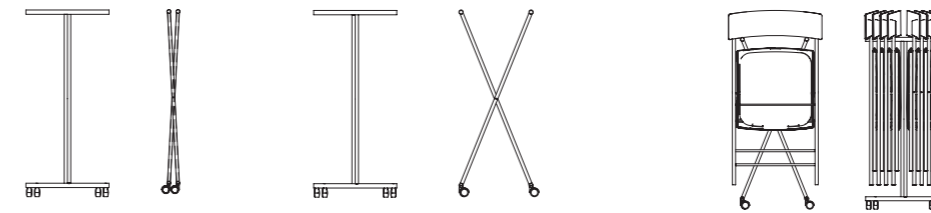

CS01 - Chiuso / Closed
cm 9 × 39 × h 94

Aperto / Open
cm 34 × 39 × h 87

Aperto con sedie / Open with chairs
cm 46 × 39 × h 98



AS02

Design: Pezzani

Ita Questa utilissima mensola multifunzione realizzata in acciaio verniciato sablé, porta fino a 6 sedie Piper o Zeta. Quando le sedie sono in uso si trasforma in portabiti e porta-grucce.

En This useful multipurpose chairs-holder shelf made of colored steel is suitable for max 6 chairs Piper or Zeta. It turns into a coat-hanger when chairs are in use.

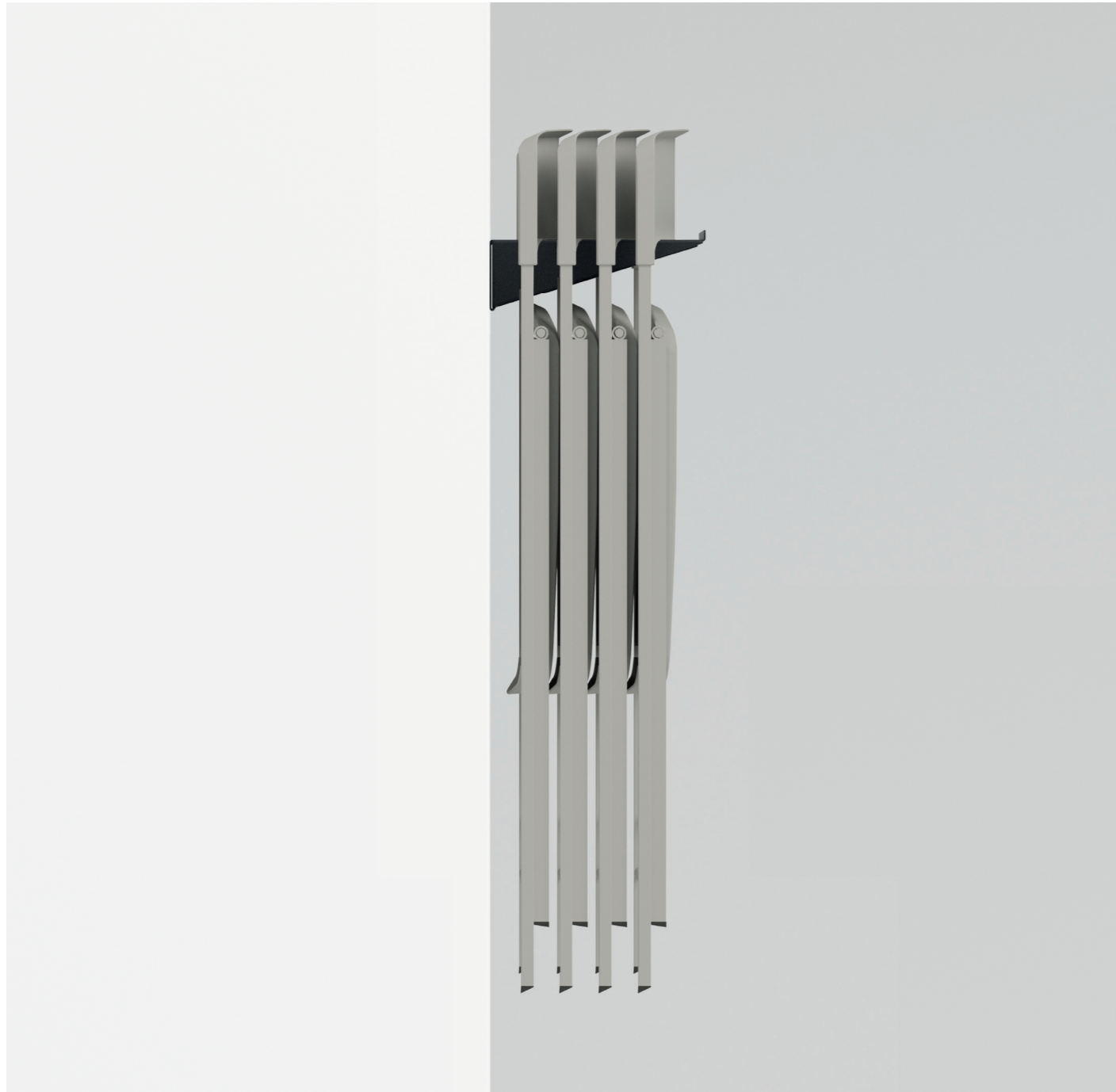

Dimensioni / Size

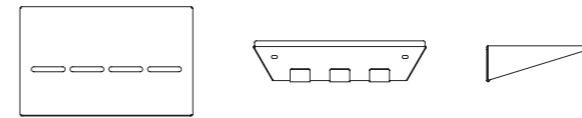

AS02
cm 35 x 22 x h 7



Brighton

Design: Pezzani

Ita Tavolino multifunzione con piano alzabile che nasconde un pratico contenitore. La struttura è in Laminato Ecologico da 18 e 25 mm ed i fianchi in acciaio verniciato con finitura sablé. Il sistema di sollevamento è pratico e funzionale: il top si solleva di 25 cm e si sposta in avanti di ben 35 cm e rende agevole il suo utilizzo quando si è comodamente seduti sul divano.

En Multipurpose table with lift top that hides a practical box. Structure made of Eco-friendly laminate 18 and 25 mm thick. Sandblasted colored steel sides. Our lift system is very practical and functional: the top raises 25 cm and moves 35 cm forward for an easy use while comfortably sitting on the sofa.



Scansiona il QR code e scopri come funziona l'apertura / Scan the QR code and discover how it works



Dimensioni / Size



0/265 - Chiuso / Closed
cm 80 × 70 × 40

Aperto / Open
80 × 70 + 35 × h 65

0/266 - Chiuso / Closed
cm 110 × 70 × h 40

Aperto / Open
cm 110 × 70 + 35 × h 65

Finiture / Finishes



Colori e combinazioni disponibili nella web app Pezzani
Colors and combinations available in Pezzani's web app



London

Design: Pezzani

Ita Tavolino multifunzione con piano alzabile che nasconde un pratico contenitore. La struttura è in Laminato Ecologico da 18 e 25 mm ed i fianchi in vetro temperato trasparente spessore 10 mm. Il sistema di sollevamento è pratico e funzionale: il top si solleva di 25 cm e si sposta in avanti di ben 35 cm e rende agevole il suo utilizzo quando si è comodamente seduti sul divano.

En Multipurpose table with lift top that hides a practical box. Structure made of Eco-friendly laminate 18 and 25 mm thick. Sides made of toughened clear glass 10 mm thick. Lift system is very practical and functional: the top raises 25 cm and moves 35 cm forward for an easy use while comfortably sitting on the sofa.



Scansiona il QR code e scopri come funziona l'apertura
/ Scan the QR code and discover how it works



Dimensioni / Size

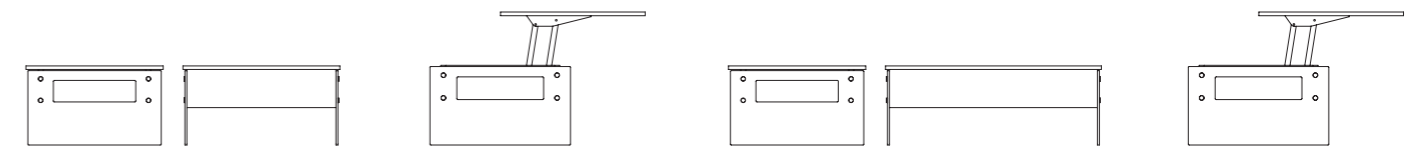

0/262 - Chiuso / Closed
cm 80 x 70 x 40

Aperto / Open
80 x 70 + 35 x h 65

0/263 - Chiuso / Closed
cm 110 x 70 x 40

Aperto / Open
110 x 70 + 35 x h 65

Finiture / Finishes



Colori e combinazioni disponibili nella web app Pezzani
Colors and combinations available in Pezzani's web app



Hide



Ita La specchiera da terra HIDE misura solo 40 cm in larghezza e trova facile collocazione in spazi ridotti. E' realizzata con vetri dai sofisticati colori: il vetro trasparente grigio fumé (o bronzo) fa da cornice allo specchio grigio fumé (o bronzo) che viene incollato al centro con una pellicola adesiva di sicurezza. Lo specchio è fissato ad un pannello di laminato ecologico da 12 mm che arriva a terra ed incorpora il sistema di fissaggio a parete.

En HIDE is a floor mirror 40 cm wide and it perfectly suits narrow spaces. It's made of glass with sophisticated colors: transparent smoked grey (or bronze) glass that frames the smoked grey (or bronze) mirror joint together with a special safety adhesive film. The mirror is fixed on an Eco-friendly laminate panel 12 mm thick that reaches the floor and includes the system to fix it to the wall.

Dimensioni / Size



0/547
cm 40 x 2 x h 198

Finiture / Finishes



Colori e combinazioni disponibili nella web app Pezzani
Colors and combinations available in Pezzani's web app



Hide+

Ita La specchiera Hide è predisposta per essere fissata al modulo libreria/portaoggetti (0/544) creando un angolo guardaroba aperto. La specchiera nasconde parzialmente alla vista il lato scarpiera/portaoggetti e quanto in essa contenuto.

En Hide mirror has been conceived to be fixed at the bookcase/storage unit 0/544 to create an open wardrobe corner. The mirror partially hides it's storage side and all it contains.

Dimensioni / Size

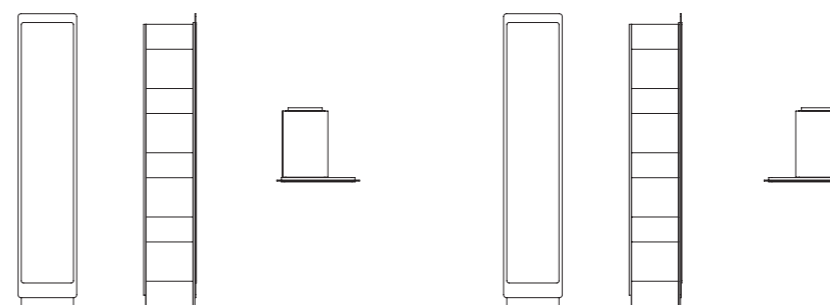

0/544 + 0/547
cm 40 × 36 × h 198

Finiture / Finishes



Colori e combinazioni disponibili nella web app Pezzani
Colors and combinations available in Pezzani's web app



1

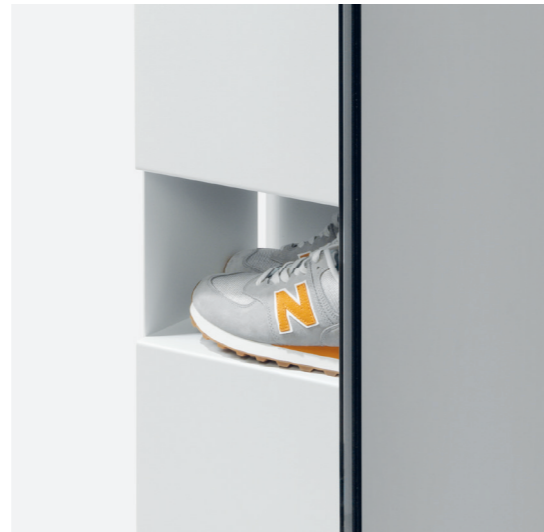

2



2

1

Il vetro trasparente grigio fumé (o bronzo) fa da cornice allo specchio grigio fumé (o bronzo) che viene incollato al centro con una pellicola adesiva di sicurezza.

Transparent smoked grey (or bronze) glass that frames the smoked grey (or bronze) mirror joint together with a special safety adhesive film.

2

La libreria/portaoggetti reversibile 0/544 realizzata in acciaio verniciato sablé, diventa struttura di sostegno per le specchiere Hide e Slide. Ha 4 ripiani sul fronte (lato libreria) e 5 sul retro (portascarpe ed oggetti).

Reversible bookcase/holder item 0/544 made of colored sandblasted steel. It is a supporting structure for Hide and Slide mirrors. It has 4 shelves on the front side (bookcase side) and 5 on the back side (for objects and shoes)

3

La specchiera reversibile HIDE è fissata sul modulo libreria 0/544 in posizione decentrata. Sporge a destra o a sinistra per nascondere parzialmente alla vista un lato della libreria/portaoggetti e quanto in essa contenuto.

HIDE reversible mirror is not fixed in the middle of bookcase unit, item 0/544. It sticks out of the unit on the right or on the left to partially hide one side of the bookcase/storage unit and all it contains.

Posizionamento consigliato / Suggested placement

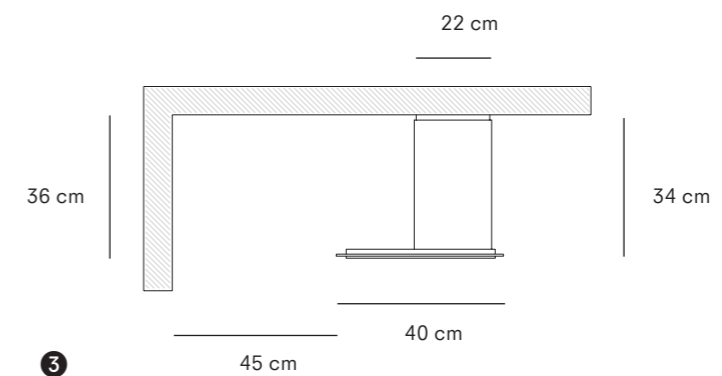

3

Finiture / Finishes



Colori e combinazioni disponibili nella web app Pezzani
Colors and combinations available in Pezzani's web app



Slide

Ita Slide è un'elegante specchiera che scorre su binari agganciati al modulo libreria/portaoggetti, creando un vano nascosto visibile solo quando lo specchio è aperto. Soluzione elegante per trasformare un piccolo spazio ad angolo in un prezioso guardaroba dove riporre scarpe, abiti e molto altro.

En Slide is an elegant mirror that slides on the tracks fixed to the bookcase/storage unit, by creating a hidden space visible only when mirror is open. This is a smart solution to convert small corners in precious wardrobes where you can put shoes, clothes and much more.

Dimensioni / Size

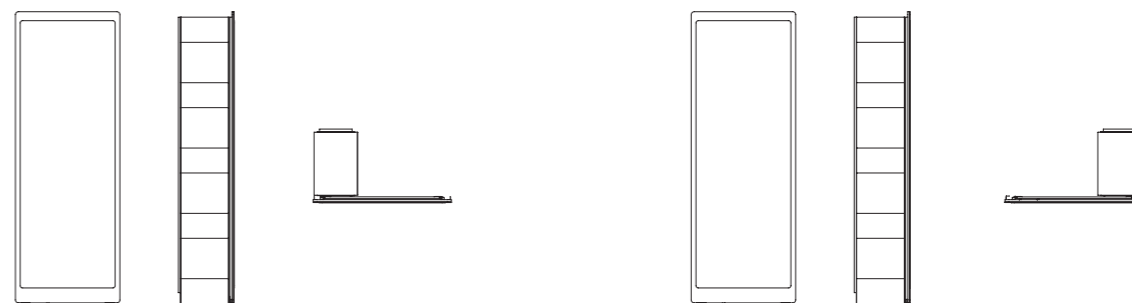

0/548 + 0/544
cm 70 × 38 × h 198

Finiture / Finishes



Colori e combinazioni disponibili nella web app Pezzani
Colors and combinations available in Pezzani's web app





1



2

1

La specchiera scorrevole Slide è realizzata con un sofisticato vetro a specchio grigio fumé (o bronzo) spessore 5 mm con fascia esterna acidata che ne disegna la cornice, accoppiato ad un pannello in laminato con finitura nero carbone da 12 mm.

Slide mirror is made of refined smoked grey (or bronze) mirror glass 5 mm thick with external frosted band that outlines its frame, fixed to a carbon black finished laminate panel 12 mm thick.

2

Libreria/portaoggetti reversibile 0/544 realizzata in acciaio verniciato sablé, diventa struttura di sostegno per le specchiere Hide e Slide. Ha 4 ripiani sul fronte (lato libreria) e 5 sul retro (porta-scarpe ed oggetti).

Reversible bookcase/storage unit 0/544 made of colored sandblasted steel. It is a supporting structure for Hide and Slide mirrors. It has 4 shelves on the front side (bookcase side) and 5 on the back side (for objects and shoes)

3

Lo specchio è montato su un pannello di laminato da 12 mm dotato di ruote e guide di scorrimento. Dettaglio del pannello in dotazione nel modulo libreria per compensare il battiscopa.

The mirror is fixed to a laminate panel 12 mm thick with castors and sliding tracks. Detail of the laminate panel included into the bookcase unit to compensate the baseboard thickness.



3

Posizionamento a parete / Wall placement

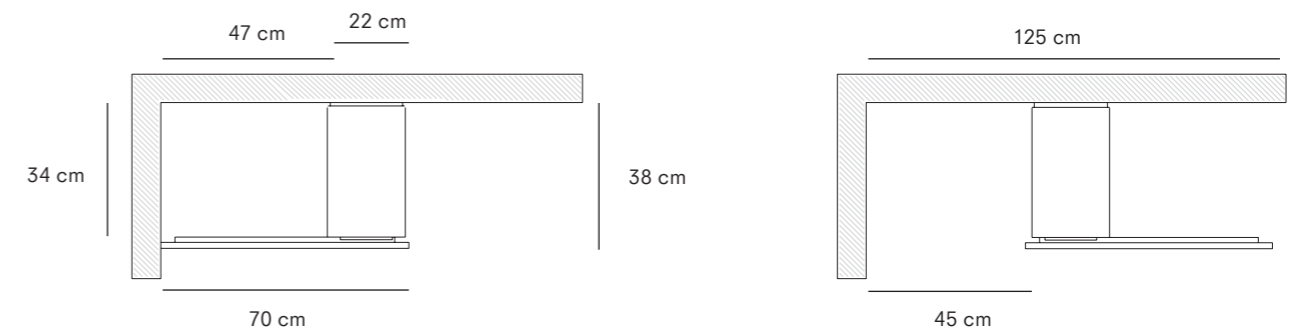

Chiuso / Closed

Aperto / Open



Scansiona il QR code e scopri come funziona l'apertura / Scan the QR code and discover how it works

Finiture / Finishes



Colori e combinazioni disponibili nella web app Pezzani
Colors and combinations available in Pezzani's web app

Angolo



Ita Angolo trasforma lo specchio Riflesso in un prezioso guardaroba dove riporre scarpe, abiti e molto altro. Il kit è composto dallo specchio Riflesso (0/532) con cornice in alluminio verniciato con finitura sablé, dal pannello in MDF laccato che rifinisce il retro dello specchio e dal montante in alluminio verniciato bianco (struttura di sostegno dello specchio da fissare a parete) completo di cerniere.

En Angolo converts Riflesso mirror into precious corner-wardrobes where you can put shoes, dresses and much more. The set is composed of Riflesso mirror (0/532) with aluminium frame sandblasted finished, a lacquered MDF panel that completes the mirror back and a white colored aluminium jamb (to fix the mirror to the wall) joints included.

Dimensioni / Size

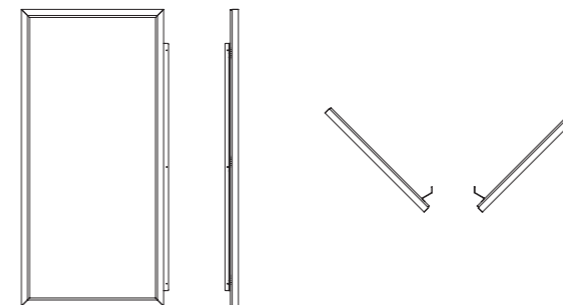

0/540 reversibile + 0/532
cm 90 × 5 × h 192 (specchio / mirror)

Finiture / Finishes



Colori e combinazioni disponibili nella web app Pezzani
Colors and combinations available in Pezzani's web app





1



0/68
cm 50 × 15 × h 15



0/545
cm 51 × 17 × h 41



0/326
cm 25 × 5 × h 12



0/322 - 0/324
cm 20 × 5 × h 5
cm 45 × 5 × h 5

3

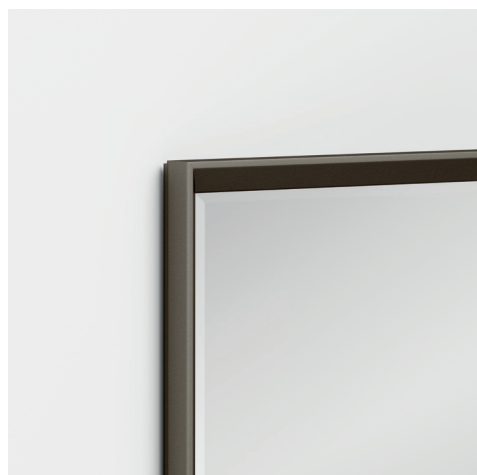
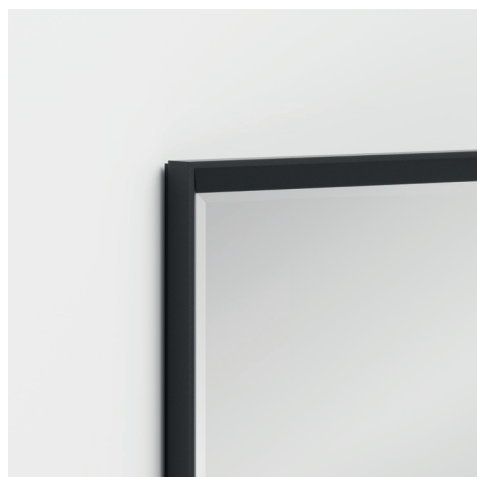

2



Scansiona il QR code e scopri come funziona l'apertura / Scan the QR code and discover how it works

1

La struttura di sostegno Angolo (0/540) della specchiera Riflesso (0/532) è composta da un montante in alluminio reversibile verniciato bianco (da fissare a parete), da solide cerniere di collegamento tra montante e cornice dello specchio e dal pannello in MDF laccato che rifinisce il retro dello specchio stesso.

Angolo equipment (0/540) to fix Riflesso mirror (0/532) to the wall is composed of a white colored aluminium reversible jamb (to be fixed to the wall), solid joints to connect jamb and mirror frame and a lacquered MDF panel that complete the mirror back.

2

La cornice della specchiera Riflesso (0/532) è realizzata in alluminio verniciato con le nostre finiture sablé. Il vetro a specchio ha il bordo bisellato.

Riflesso mirror frame (0/532) is made of sandblasted colored aluminium. Mirror glass with bevel.

3

Accessori interni (opzionali): mensola a 2 ripiani e portabiti realizzati acciaio con finitura sablé; scarpiera modulare sovrapponibile in polipropilene.

Inner equipment (optional): shelf and coat-hangers made of sandblasted colored steel; modular and stackable shoe-rack made of polypropylene.



Rettangolo



Ita Rettangolo è un altro modo di trasformare una preziosa specchiera in un pratico guardaroba. Lo si ottiene aggiungendo alla specchiera Riflesso (0/532), la struttura di sostegno a battente (0/543) e la libreria/portaoggetti (0/544) che diventa esternamente la colonna di chiusura del vano. La composizione Rettangolo ha una profondità di soli 39 cm, ma al suo interno trovano spazio scarpe, abiti e molto altro.

En Rettangolo is another way to convert a precious mirror into a practical wardrobe, by adding to Riflesso mirror (0/532) a swing supporting structure (0/543) and the bookcase/storage unit (0/544) that will be the external column that close the wardrobe. Rettangolo composition is only 39 cm deep, but inside you can put shoes, clothes and much more.

Dimensioni / Size

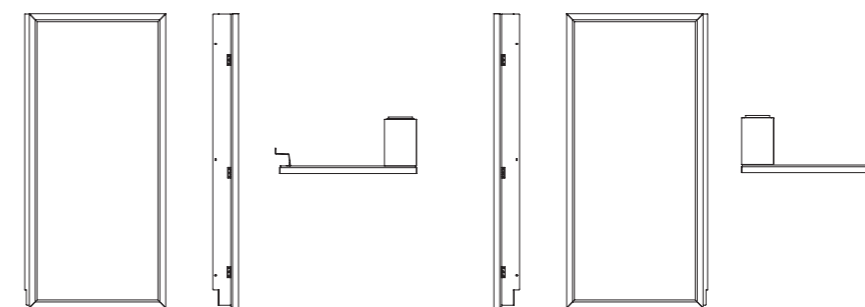

0/543.DX + 0/532 + 0/544
cm 95 × 39 × h 192

0/543.SX + 0/532 + 0/544
cm 95 × 39 × h 192

Finiture / Finishes



Colori e combinazioni disponibili nella web app Pezzani
Colors and combinations available in Pezzani's web app





1



0/68
cm 50 × 15 × h 15



AS02
cm 35 × 22 × h 7



0/326
cm 25 × 5 × h 12



0/322 - 0/324
cm 20 × 5 × h 5
cm 45 × 5 × h 5

3

1

La struttura di sostegno Rettangolo (0/543) della specchiera Riflesso (0/532) è composta da un montante in acciaio destro o sinistro verniciato bianco (da fissare a parete), da solide cerniere di collegamento tra montante e cornice dello specchio e dal pannello in MDF laccato che rifinisce il retro dello specchio stesso.

Rettangolo equipment (0/543) to fix Riflesso mirror (0/532) to the wall is composed of a white colored aluminium left or right jamb (to be fixed to the wall), solid joints to connect jamb and mirror frame, a lacquered MDF panel that complete the mirror back.

2

La libreria/portaoggetti reversibile (0/544), realizzata in acciaio verniciato sablé, ha 4 ripiani sul fronte (lato libreria) e 5 sul retro (portascarpe ed oggetti).

The reversible bookcase/storage unit (0/544) is made of colored sandblasted steel. It has 4 shelves on the front side (bookcase side) and 5 on the back side (for objects and shoes).

3

Accessori interni (opzionali): mensola a 2 ripiani, mensola portasedie/portabiti, portabiti vari, tutti realizzati in acciaio verniciato con finitura sablé.

Inner equipment (optionals): shelf, chairs-holder shelf and coat-hangers made of sandblasted colored steel.



2



Scansiona il QR code e scopri come funziona l'apertura / Scan the QR code and discover how it works

Finiture / Finishes



Colori e combinazioni disponibili nella web app Pezzani
Colors and combinations available in Pezzani's web app

Rettangolo

Select

Design: Pezzani

Ita Il carrello chiudibile Select rappresenta un'icona del design Pezzani. Il solo prodotto rimasto in produzione ininterrottamente dagli anni '70 ad oggi. E' realizzato unendo esperienza e tradizione artigiana alle più avanzate tecnologie di produzione, utilizzando esclusivamente materiali di prima qualità e finiture estremamente resistenti (una solida struttura in acciaio cromato o verniciato con finitura sablé e ripiani in resistente formica), per garantire la massima solidità strutturale di un oggetto unico destinato a durare nel tempo. Scopri di più sul carrello Select nel video che ne spiega in dettaglio il funzionamento.

En The Select foldable cart is an icon of Pezzani design. It is the only item continuously produced from the 1970s. Manufactured combining experience and traditional craftsmanship with the most advanced manufacturing technology using high-end materials and extremely enduring finishes (chrome plated or sandblasted colored steel structure and formica trays), to ensure the structural integrity of this everlasting piece. Find more about Select cart in the video that explains how it works.



Scansiona il QR code e scopri come funziona l'apertura / Scan the QR code and discover how it works



Dimensioni / Size



0/142 - Chiuso / Closed
cm 63 x 7 x h 67

Aperto / Open
63 x 41,5 x h 86

Finiture / Finishes



Colori e combinazioni disponibili nella web app Pezzani
Colors and combinations available in Pezzani's web app



Pezzani srl
Via Papini 33
43036 Fidenza, Parma (Italy)

T +39 0524 525440
info@pezzani.eu
www.pezzani.eu

📸 @pezzaniofficial
f /pezzaniofficial
📍 /pezzani_official

Art direction and Graphic design
Andrea Bianchi

Photography
Federico Villa

Styling
Sara Dassi

Still Life Images
Rafael Eifler Barbosa

Aknowledgments
Artemide
Danese
Enrico Donadello
Francesco Zurlini
Giorgia Orlandelli
Ilaria Franza
Martina Geroni
Materie Plastiche Paolillo
Morfosi
Roberto Sironi

Printing
Grafiche Sagi

L'azienda si riserva il diritto di modificare od eliminare gli articoli contenuti in questo catalogo in qualsiasi momento senza preavviso. L'azienda è proprietaria esclusiva del catalogo e del materiale fotografico in essa contenuto; riproduzione vietata. I colori riportati nel catalogo sono solo indicativi e possono differire da quelli reali degli oggetti ai quali si riferiscono.

The company has the right to change or delete items from this catalogue without notice. Copyright notice: the company is the sole owner of this catalogue and its pictures; copies are strictly prohibited. The colors of this catalogue are only approximate, they can be different from the real ones.



