

Chairs and tables



pezzani

Index Tavoli / Tables

Eiffel 10
Vertigo 20
Monolith R 32
Monolith T 44

Tavolini trasformabili
/ Multipurpose coffee tables

Liverpool 52

Sedie / Chairs

Dafne 54
Olimpe 62
Polly 70
Minerva 78
Medea 86
Morgana 94
Alissa 98
Circe 104

In questo catalogo
abbiamo messo al centro
la convivialità, il piacere di
ricevere e di condividere
la bellezza della propria
casa.

In questo catalogo abbiamo messo al centro la convivialità, il piacere di ricevere e di condividere la bellezza della propria casa.

Lo abbiamo fatto creando una collezione di tavoli da soggiorno dal design unico e ricercato, ai quali sono state abbinare una serie di sedie, poltroncine e sgabelli "tailormade" eleganti e confortevoli. Articoli concepiti per trasformare l'area living in un ambiente accogliente dall'atmosfera rilassante e conviviale, disegnati e prodotti in Italia, ma pensati per le case di tutto il mondo.

La nuova collezione completa la già ricca proposta di complementi d'arredo Pezzani, per offrire ancora maggiori opportunità di espressione, con prodotti personalizzabili che solo una lunga tradizione ed esperienza artigianale, l'ossessione per la qualità e la cura dei dettagli combinate alla creatività, al talento ed alla competenza nel design, possono esprimere.

This catalogue is focused on conviviality, pleasure to host and to share the beauty of our homes.

We did this by creating a collection of living room tables with a unique and refined design to match with elegant and comfortable "tailor-made" chairs, armchairs and stools. These items are conceived to transform the living area to get a warm and friendly welcome in a relaxed and convivial ambiance. They are designed and produced in Italy, but made to fit homes worldwide.

This new collection of chairs and tables expands the wide Pezzani proposal of interior furnishing, to offer even greater opportunity of expression thanks to tailor-made products that only a long tradition of craftsmanship experience, the obsession for quality and care for details combined with creativity, talent and design competences can deliver.

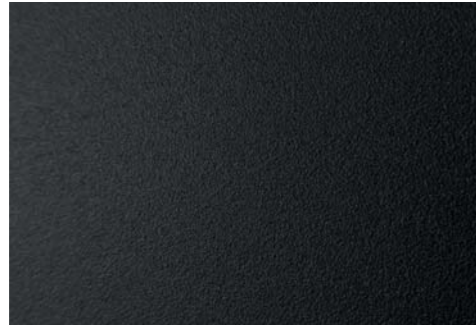
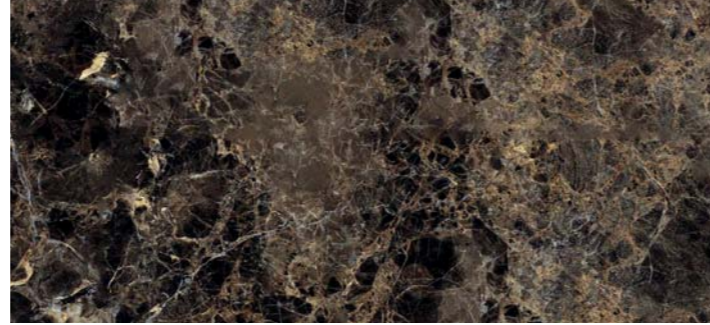
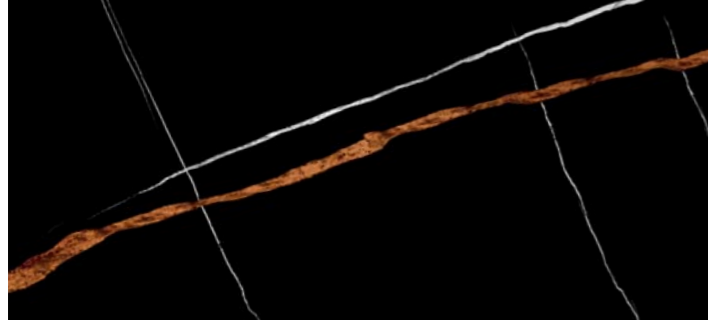
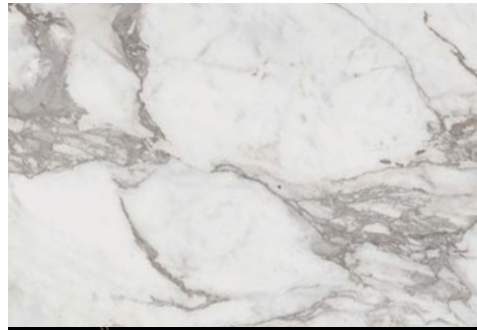

Molteplici combinazioni

I colori ed i materiali giocano un ruolo fondamentale nel modo di arredare e vivere la casa. Trovare il giusto abbinamento è importante da un punto di vista estetico, ma un'adeguata scelta dei colori favorisce anche il nostro benessere e condiziona il nostro stato d'animo. In questa collezione proponiamo una selezione di finiture e colori che si combinano fra loro armoniosamente per creare ambienti confortevoli.

Nella nostra collezione di tavoli, il protagonista è il vetro grigio fumé o bronzo, (trasparente o forgiato a caldo) oppure extra chiaro con stampe ad alta risoluzione che riproducono i marmi più pregiati. Il tutto si abbina armoniosamente ai riflessi di luce del metallo verniciato a caldo con effetto sablé, dando origine ad innumerevoli possibili combinazioni di colori.

Several combinations

Colours play an essential role in the way we furnish and live in our homes. Finding the right combination is important from an aesthetic point of view, but the right choice of colours also influences our sense of well-being and mood. In this collection, we offer a selection of finishes and colours that harmoniously combine themselves to create comfortable environments.

In our tables collection, the protagonist is the glass, either smoke grey or bronze coloured with transparent or hot-forged finish, or extra clear decorated with the reproduction of the most precious marbles. Everything is harmoniously combined with the light reflections of the hot-painted metal with sablé effect, resulting in countless possible colour combinations to meet every need.

Fatto su misura

Grazie ad una sorprendente serie di finiture e colori, materiali di alta qualità e design in stili diversi, vi offriamo la possibilità di creare pezzi di arredamento unici made in Italy.

Le nostre sedie possono essere rivestite con tessuti pregiati (Puntino, Miele, etc.), tessuti lavabili Acquaclean, velluto, similpelle e vera pelle, che potrete abbinare a scelta con le numerose basi proposte in metallo verniciato sablé o cromato.

Potrete personalizzare ulteriormente le sedie scegliendo tonalità a contrasto per i rivestimenti, perché offriamo la possibilità di abbinare sulla stessa seduta, colori o materiali diversi, ed anche superfici trapuntate.

Questa collezione di sedie, poltroncine e sgabelli vi consentirà di sentirvi totalmente a proprio agio seduti nel massimo comfort.

Tailor-made

Thanks to an amazingly wide range of finishing and colours, top quality materials and design styles, we offer you the experience of creating your own personal made in Italy piece of furniture.

Our chairs can be upholstered with precious (Puntino and Miele) or washable (Acquaclean) fabrics, velvet, leatherette and leather that you can combine, at your choice, with several colored or chrome plated metal bases.

You can customize even further your chair by choosing contrast hues for the upholstery, as we give you the opportunity to have different colours, materials and also quilted surfaces for the same seat.

This collection will offer you the great feeling of living your house in total comfort thanks to a collection of chairs, armchairs and stools for every taste and need.

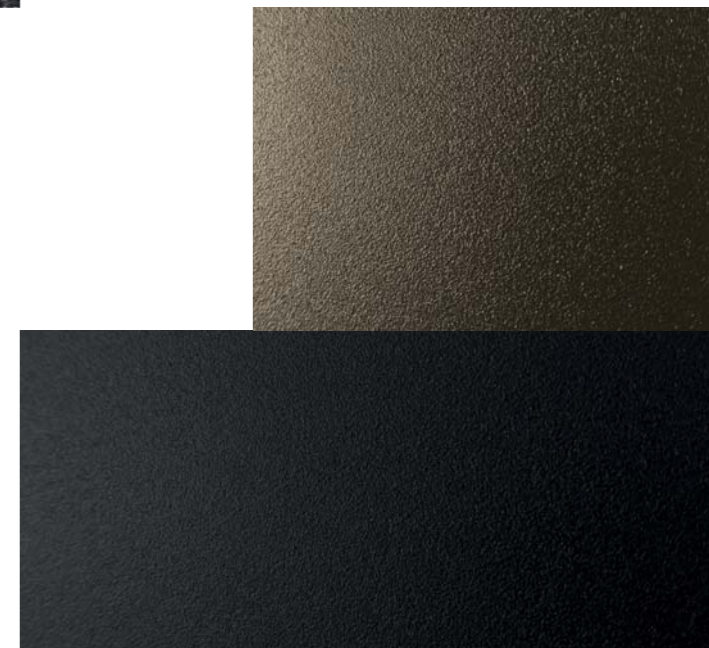
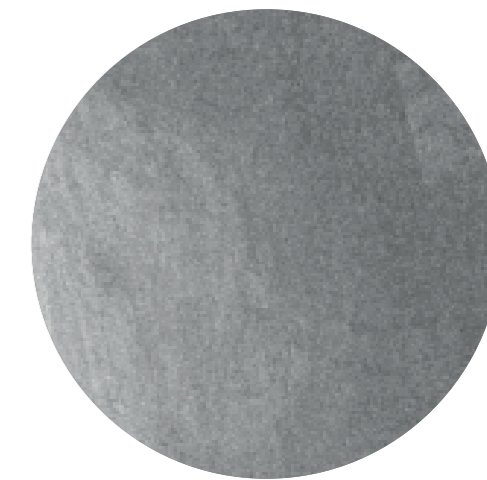
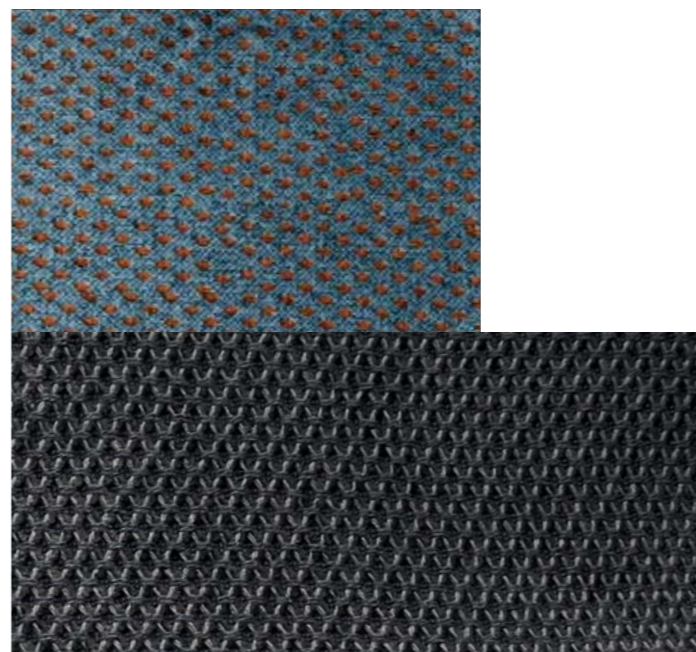



Eiffel

Ita La struttura dal design ricercato di questo magnifico tavolo evoca quello dell'omonima tour Eiffel di Parigi ed è realizzata in solida lamina d'acciaio ad alto spessore, verniciata con le nostre finiture sablé, e si sposa perfettamente con i sofisticati top in vetro disponibili in tre varianti. Per la prima, sono previsti eleganti vetri trasparenti temperati colorati bronzo o grigio fumé, spessore 10 mm, che lasciano trasparire l'imponente struttura. La seconda è l'esclusiva variante vetro forgiato a caldo, dove gli stessi vetri bronzo o grigio fumé vengono scaldati fino al punto di fusione a 740° e pressati per ottenere un effetto finemente ondulato che, per specchiatura e trasparenza, richiama la superficie dell'acqua leggermente increspata. In alternativa alle prime due varianti, sono disponibili anche innovativi top in vetro extrachiaro stampati in digitale con decoro marmo Sahara noir, Emperador brown e bianco Calacatta. La lucentezza ed i riflessi del vetro extrachiaro, uniti alla qualità della stampa ad altissima risoluzione, rendono stupefacente la definizione ed i colori del decoro marmo.

En The refined structure of this magnificent table, whose design is inspired by the tour Eiffel in Paris, is made of very strong steel coloured with our sandblasted finishing. It perfectly matches with the sophisticated glass tops that are available in three different variants. The first one is an elegant toughened transparent glass 10 mm thick, smoke grey or bronze coloured, that lets the imponent structure shine through. The second is the exclusive hot forged glass. This variant is provided with 10 mm thick smoke grey or bronze glass, heated in an oven at 740°, then pressed to obtain a finely wavy effect, reminding slightly rippled water surface. As an alternative to these two variants, you can choose innovative extra-clear glass tops digitally printed with Sahara noir, Emperador brown or Calacatta white marble decoration. The brightness and reflections of extra-clear glass, combined with extraordinary quality of high-resolution printing, make the marble decoration amazing.





0/810 200R - vetro Grigio fumé forgiato ad angoli raggianti + struttura Nero sablé
/ Forged smoke grey glass with rounded corners + Sandblasted black structure
cm 200 x 100 x h 75

Dettaglio del sofisticato vetro grigio fumé forgiato a caldo con bordo filo lucido piatto. Il vetro grigio fumé (o bronzo) spessore 10 mm viene scaldato fino al punto di fusione a 740° e pressato per ottenere un effetto finemente ondulato che, per specchiatura e trasparenza, richiama la superficie dell'acqua leggermente increspata.

Detail of the sophisticated bronze hot forged glass with flat polished edge. Bronze (or smoke grey) 10 mm glass is heated in an oven at 740°, then pressed to obtain a finely wavy effect, reminding slightly rippled water surface.



Dettaglio vetro Grigio fumé forgiato
/ Forged smoke-grey glass detail



0/810 240B- vetro Marmo bianco sagomato a botte + struttura Grigio ardesia sablé
/ White marble glass with barrel shape + Sandblasted ardesia grey structure
cm 240 x 110 x h 75



0/810 240B - vetro Bronzo trasparente sagomato a botte + struttura Bronzo sablé
/ Transparent bronze glass with barrel shape + Sandblasted bronze structure



1



2

Caratteristiche principali / Main features

1

Dettaglio del top sagomato con angoli raggio 150 mm e bordo bisellato delle versioni 200.R e 240.B, realizzato in vetro extrachiario, stampato in digitale con decoro marmo. Nei top rettangolari ad angoli retti delle versioni 200.A e 240.A il bordo invece è filo lucido piatto. Per maggiori dettagli sulle caratteristiche di questi vetri, consultare il nostro listino.

Detail of the shaped top (version 200.R and 240.B) with corners 150 mm radius and bevelled edge, made of extra-clear glass digital printed with marble decoration. The rectangular tops with right corners (version 200.A and 240.A) instead have flat polished edges. Check our pricelist for more details about features of these glass.

2

Dettaglio del top in vetro bronzo trasparente temperato spessore 10 mm con bordo filo lucido piatto, la versione che esalta maggiormente la magnifica struttura realizzata in solida lamina d'acciaio da 6/8 mm di spessore con finitura bronzo sablé.

Detail of the top made of toughened transparent bronze glass 10 mm thick with flat polished edge. This is the version that better enhances the magnificent structure (made of very strong steel foil 8/6 mm thick) with sandblasted bronze finishing.

3

Su richiesta questo tavolo può essere fornito lungo cm 280.

On demand this table is available also cm 280 long.

Dimensioni / Size

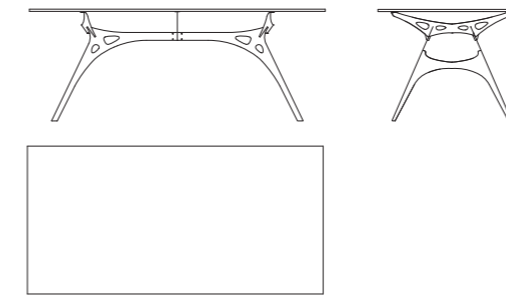

0/810 200.A
cm 200 × 100 x h 75

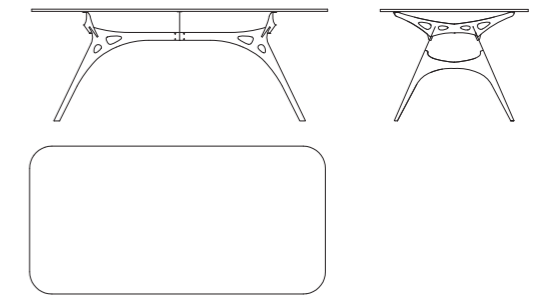

0/810 200.R
cm 200 × 100 x h 75

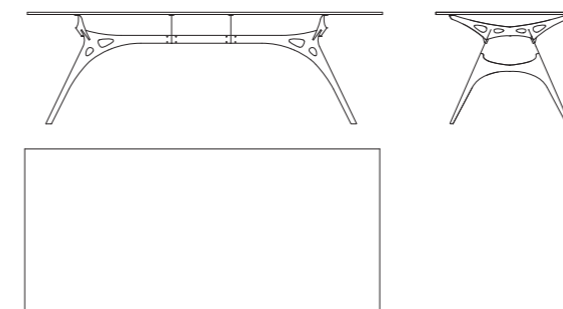

0/810 240.A
cm 240 × 110 x h 75

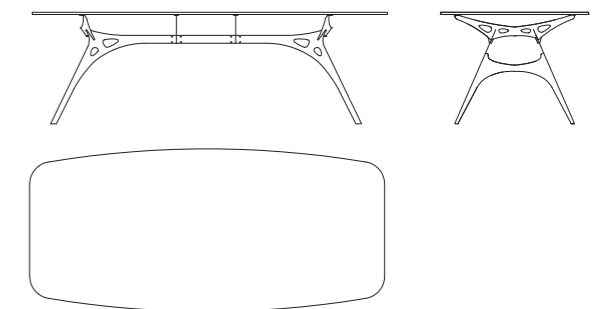

0/810 240.B
cm 240 × 110 x h 75

Finiture / Finishes



Colori e combinazioni disponibili nella web app Pezzani
Colors and combinations available in Pezzani's web app



Vertigo

Ita La struttura dall'originale design di questo elegante tavolo è realizzata in solido tubolare d'acciaio di forma rettangolare, verniciata con le nostre finiture sablé, e si sposa perfettamente con i sofisticati top in vetro disponibili in tre varianti. Per la prima, sono previsti eleganti vetri trasparenti temperati colorati bronzo o grigio fumé, spessore 10 mm, che lasciano trasparire l'imponente struttura. La seconda è l'esclusiva variante vetro forgiato a caldo, dove gli stessi vetri (bronzo o grigio fumé) sono scaldati fino al punto di fusione a 740° e pressati per ottenere un effetto finemente ondulato che, per specchiatura e trasparenza, richiama la superficie dell'acqua leggermente increspata. In alternativa alle prime due varianti, sono disponibili anche innovativi top in vetro extrachiaro stampati in digitale con decoro marmo Sahara noir, Emperador brown e bianco Calacatta. La lucidità ed i riflessi del vetro extrachiaro, uniti alla qualità della stampa ad altissima risoluzione, rendono stupefacente la definizione ed i colori del decoro marmo.

En The elegant structure of this table, is made of strong steel tubular with rectangular shape, coloured with our sandblasted finishing. It perfectly matches with the sophisticated glass tops that are available in three different variants. The first one is an elegant toughened transparent glass 10 mm thick, smoke grey or bronze coloured, that lets the imponent structure shine through. The second is the exclusive hot forged glass. This variant is provided with 10 mm thick smoke grey or bronze glass, heated in an oven at 740°, then pressed to obtain a finely wavy effect, reminding slightly rippled water surface. As an alternative to these two variants, you can choose innovative extra-clear glass tops digitally printed with Calacatta white, Emperador brown or Sahara noir marble decoration. The brightness and reflections of extra-clear glass combined with extraordinary quality of high-resolution printing, make the marble decoration amazing.





0/800 200R - vetro Bronzo trasparente con angoli raggati + Bronzo sablé
/ Transparent bronze glass with rounded corners + Sandblasted bronze structure
cm 200 x 100 x h 75



0/800 200A - vetro Fumè forgiato ad angoli retti + struttura Nero sablé
/ Forged smoke grey glass with right corners + Sandblasted black structure



0/800 200L - vetro Sahara noir ad angoli retti + struttura Nero sablé - aperto
/ Sahara noir glass with right corners + Sandblasted black structure - open
cm 290 (45+200+45) x 100 x h 75



Dimensioni / Size

1 Tavoli fissi / Dining tables

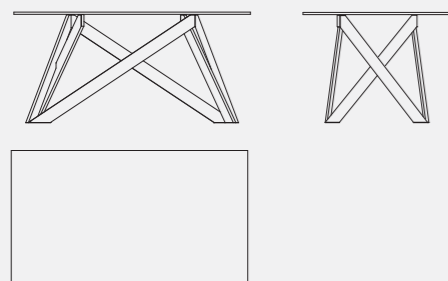

0/800 160.A
cm 160 × 90 x h 75

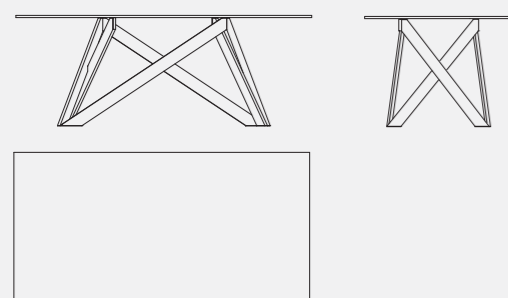

0/800 200.A
cm 200 × 100 x h 75

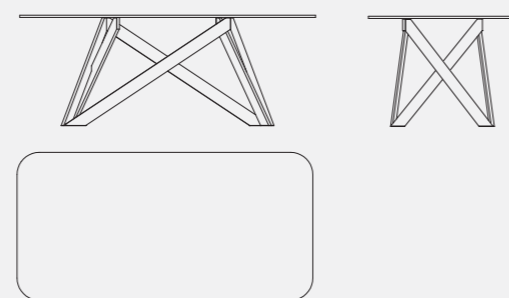

0/800 200.R
cm 200 × 100 x h 75

2 Tavoli allungabili / Extendible tables

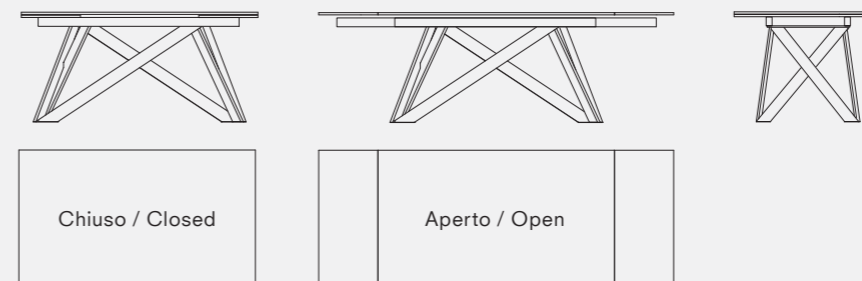

0/800 160.L
cm 160 × 90 x h 75

cm 240 (40 + 160 + 40) × 90 x h 75

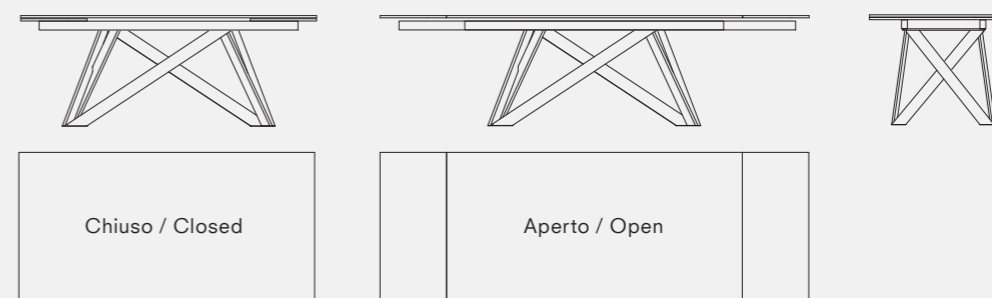

0/800 200.L
cm 200 × 100 x h 75

cm 290 (45 + 200 + 45) × 100 x h 75

Finiture / Finishes

→ Colori e codici dei moduli sono precisati a listino
Elements code and colors available in our pricelist

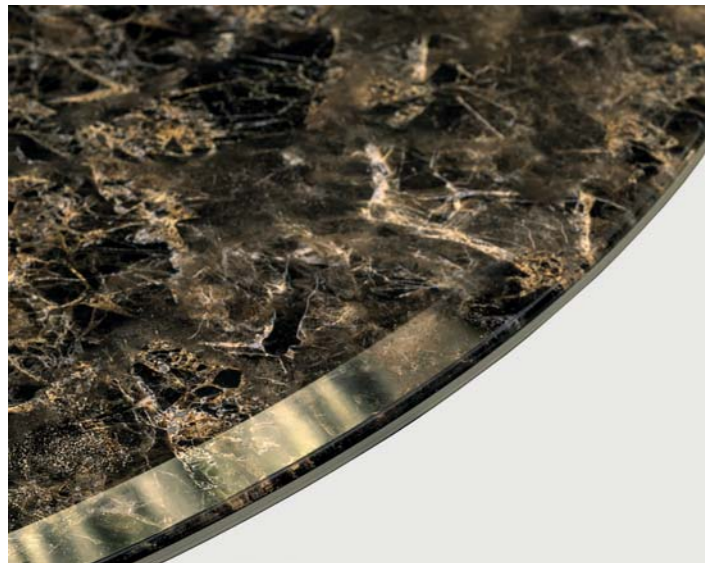

1



2

Caratteristiche principali / Main features

1

Dettaglio del top sagomato con angoli raggio 150 mm e bordo bisellato della versione 200.R, realizzato in vetro extra-chiaro, stampato in digitale con decoro marmo. Nei top rettangolari ad angoli retti e le loro allunghe, il bordo invece è filo lucido piatto. Per maggiori dettagli sulle caratteristiche di questi vetri, consultare il nostro listino.

Detail of the shaped top (version 200.R) with corners 150 mm radius and bevelled edge, made of extra-clear glass digital printed with marble decoration. The rectangular tops and relevant extensions with right corners instead have flat polished edges. Check our pricelist for more details about features of these glass.

2

Dettaglio del sofisticato vetro bronzo forgiato a caldo con bordo filo lucido piatto. Il vetro bronzo (o grigio fumé) spessore 10 mm viene scaldato fino al punto di fusione a 740° e pressato per ottenere un effetto finemente ondulato che, per specchiatura e trasparenza, richiama la superficie dell'acqua leggermente increspata.

Detail of the sophisticated bronze hot forged glass with flat polished edge. Bronze (or smoke grey) 10 mm glass is heated in an oven at 740°, then pressed to obtain a finely wavy effect, reminding slightly rippled water surface.

3

Dettaglio del posizionamento delle allunghe in vetro stratificato quando il tavolo è chiuso.

Detail of laminated-glass extensions position when the table is closed.

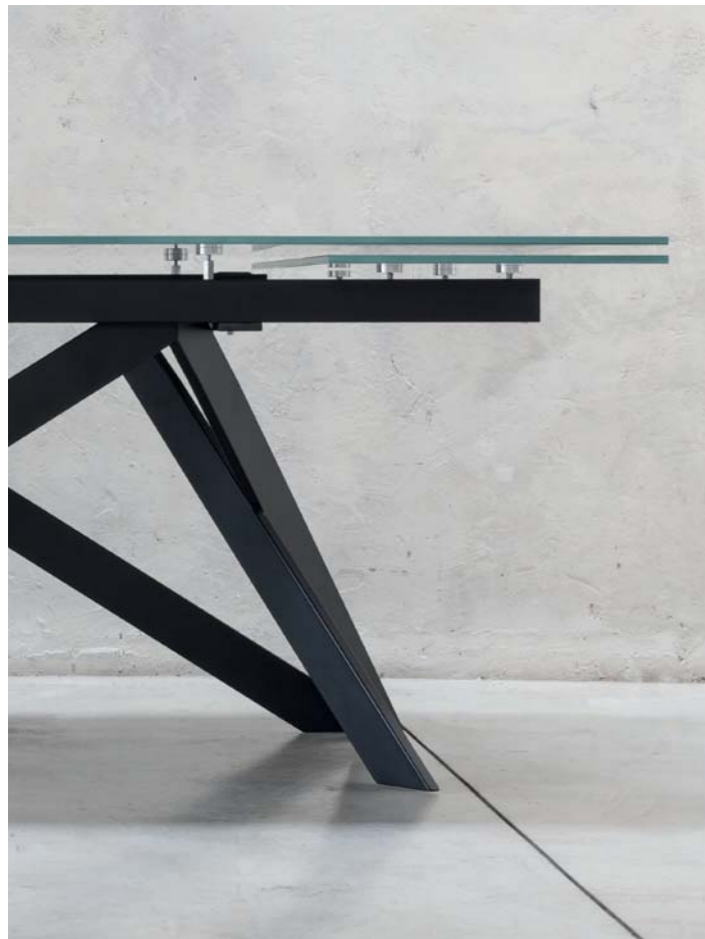

3

Finiture / Finishes



Colori e combinazioni disponibili nella web app Pezzani
Colors and combinations available in Pezzani's web app

Monolith R



Ita Questo bellissimo tavolo dal design ricercato è realizzato con una solida struttura in lamina d'acciaio, verniciata con le nostre finiture sablé, e si sposa perfettamente con i sofisticati top in vetro disponibili in tre varianti. Per la prima, sono previsti eleganti vetri trasparenti temperati colorati bronzo o grigio fumé, spessore 10 mm, che lasciano trasparire l'imponente struttura. La seconda è l'esclusiva variante vetro forgiato a caldo, dove gli stessi vetri bronzo o grigio fumé sono scaldati fino al punto di fusione a 740° e pressati per ottenere un effetto finemente ondulato che, per specchiatura e trasparenza, richiama la superficie dell'acqua leggermente increspata. In alternativa alla prime due varianti, sono disponibili anche innovativi top in vetro extrachiaro stampati in digitale con decoro marmo Sahara noir, Emperador brown e bianco Calacatta. La lucentezza ed i riflessi del vetro extrachiaro, uniti alla qualità della stampa ad altissima risoluzione, rendono stupefacente la definizione ed i colori del decoro marmo.

En The stylish design of this wonderful table, is due to the solid structure made of very strong steel foil coloured with our sandblasted finishing. It perfectly matches with the sophisticated glass tops that are available in three different variants. The first one is an elegant toughened transparent glass 10 mm thick, smoke grey or bronze coloured, that lets the imponent structure shine through. The second is the exclusive hot forged glass. This variant is provided with 10 mm thick smoke grey or bronze glass, heated in an oven at 740°, then pressed to obtain a finely wavy effect, reminding slightly rippled water surface. As an alternative to these two variants, you can choose innovative extra-clear glass tops digitally printed with Sahara noir, Emperador brown or Calacatta white marble decoration. Brightness and reflections of extra-clear glass combined with extraordinary quality of high-resolution printing, make the marble decoration amazing.





0/805 200R - vetro Bronzo forgiato + struttura Bronzo sablé
/ Forged bronze glass + Sandblasted bronze structure



0/805 200R - vetro Bronzo forgiato ad angoli raggianti + struttura Bronzo sablé
/ Forged bronze glass with rounded corners + Sandblasted bronze structure
cm 200 x 100 x h 75



0/805 200L - vetro Sahara noir ad angoli retti + struttura Nero sablé - aperto
/ Sahara noir glass with right corners + Sandblasted black structure - open
cm 290 (45+200+45) x 100 x h 75



Dimensioni / Size

1 Tavoli fissi / Dining tables

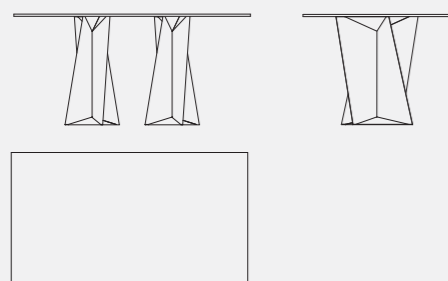

0/805 160.A
cm 160 × 90 x h 75

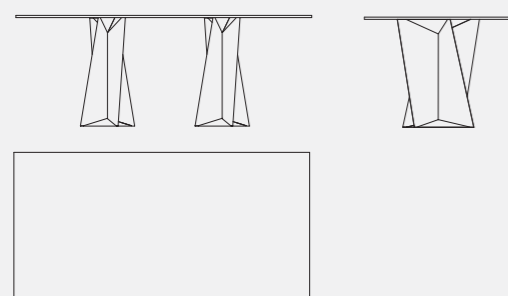

0/805 200.A
cm 200 × 100 x h 75

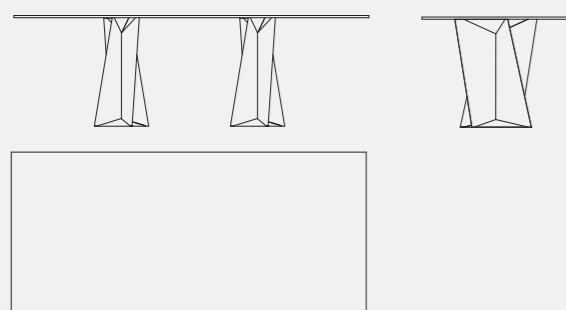

0/805 240.A
cm 240 × 110 x h 75

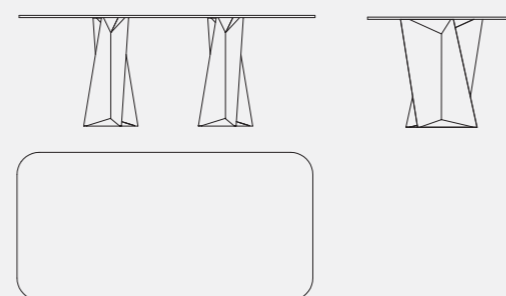

0/805 200.R
cm 200 × 100 x h 75

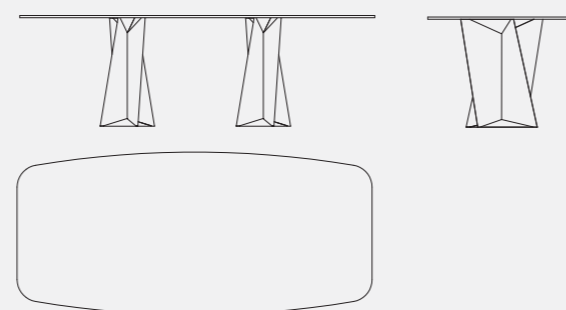

0/805 240.B
cm 240 × 110 x h 75

2 Tavoli allungabili / Extendible tables

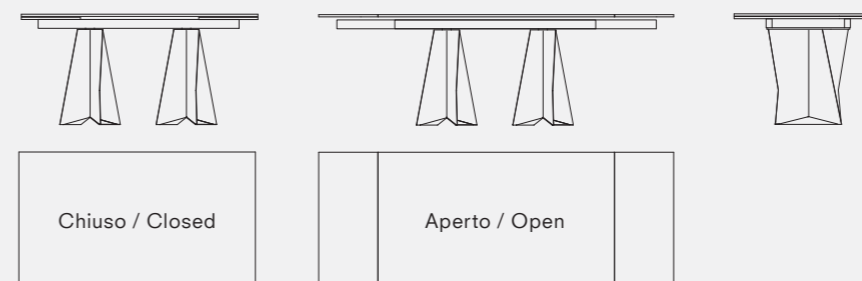

0/805 160.L
cm 160 × 90 x h 75

cm 240 (40 + 160 + 40) × 90 x h 75



0/805 200.L
cm 200 × 100 x h 75

cm 290 (45 + 200 + 45) × 100 x h 75

Finiture / Finishes

→ Colori e codici dei moduli sono precisati a listino
Elements code and colors available in our pricelist



1



2

Caratteristiche principali / Main features

1 Dettaglio del posizionamento delle allunghe in vetro quando il tavolo è chiuso. Il top e le allunghe hanno il bordo filo lucido piatto e sono in vetro extrachiaro, stampato in digitale con decoro marmo. Nel top sagomato a botte ed in quello con angoli raggio 150 mm, invece il bordo è bisellato. Per maggiori dettagli sulle caratteristiche di questi vetri, consultare il nostro listino.

Detail of glass extensions with flat polished edges positioned under the top when the table is closed. Top and extensions are made of extra clear glass digital printed with marble decoration. Shaped top with corners 150 mm radius instead have bevelled edge. Check our pricelist for more details about features of these glass.

2 Dettaglio del sofisticato vetro bronzo forgiato a caldo con bordo filo lucido piatto. Il vetro bronzo (o grigio fumé) spessore 10 mm viene scaldato fino al punto di fusione a 740° e pressato per ottenere un effetto finemente ondulato che, per specchiatura e trasparenza, richiama la superficie dell'acqua leggermente increspata.

Detail of the sophisticated bronze hot forged glass with flat polished edge. Bronze (or smoke grey) 10 mm glass is heated in an oven at 740°, then pressed to obtain a finely wavy effect, reminding slightly rippled water surface.

3 L'elegante top in vetro bronzo trasparente 10 mm con angoli raggio 150 mm e bordo filo lucido piatto, lascia trasparire l'originale forma di questa base in lamina d'acciaio con finitura bronzo sablé.

Detail of the shaped top with rounded corners (150 mm radius) made of transparent bronze glass 10 mm thick with flat polished edge. This is the version that better enhances the original shape of this steel structure with sand-blasted bronze finishing.



3

Finiture / Finishes



Colori e combinazioni disponibili nella web app Pezzani
Colors and combinations available in Pezzani's web app

Monolith T



Ita Questo bellissimo tavolo dal design imponente è realizzato con una solida struttura in lamina d'acciaio, verniciata con le nostre finiture sablé, e si sposa perfettamente con i sofisticati top in vetro disponibili in tre varianti. Per la prima, sono previsti eleganti vetri trasparenti temperati colorati bronzo o grigio fumé, spessore 10 mm, che lasciano trasparire l'imponente struttura. La seconda è l'esclusiva variante vetro forgiato a caldo, dove gli stessi vetri bronzo o grigio fumé sono scaldati fino al punto di fusione a 740° e pressati per ottenere un effetto finemente ondulato che, per specchiatura e trasparenza, richiama la superficie dell'acqua leggermente increspata. In alternativa alla prime due varianti, sono disponibili anche innovativi top in vetro extrachiaro stampati in digitale con decoro marmo Sahara noir, Emperador brown e bianco Calacatta. La lucentezza ed i riflessi del vetro extrachiaro, uniti alla qualità della stampa ad altissima risoluzione, rendono stupefacente la definizione ed i colori del decoro marmo.

En This wonderful table with a majestic design, has a solid structure made of very strong steel foil coloured with our sandblasted finishing. It perfectly matches with the sophisticated glass tops that are available in three different variants. The first one is an elegant toughened transparent glass 10 mm thick, smoke grey or bronze coloured, that lets the imponent structure shine through. The second is the exclusive hot forged glass. This variant is provided with 10 mm thick smoke grey or bronze glass, heated in an oven at 740°, then pressed to obtain a finely wavy effect, reminding slightly rippled water surface. As an alternative to these two variants, you can choose innovative extra-clear glass tops digitally printed with Sahara noir, Emperador brown or Calacatta white marble decoration. The brightness and reflections of extra-clear glass combined with extraordinary quality of high-resolution printing, make the marble decoration amazing.





0/850 120T - vetro Emperador brown + struttura Bronzo sablé
/ Emperador brown glass + Sandblasted bronze structure
cm Ø 120 × h 75



0/850 140T - vetro Bronzo trasparente + struttura Bronzo sablé
/ Transparent bronze glass + Sandblasted bronze structure
cm Ø 140 × h 75

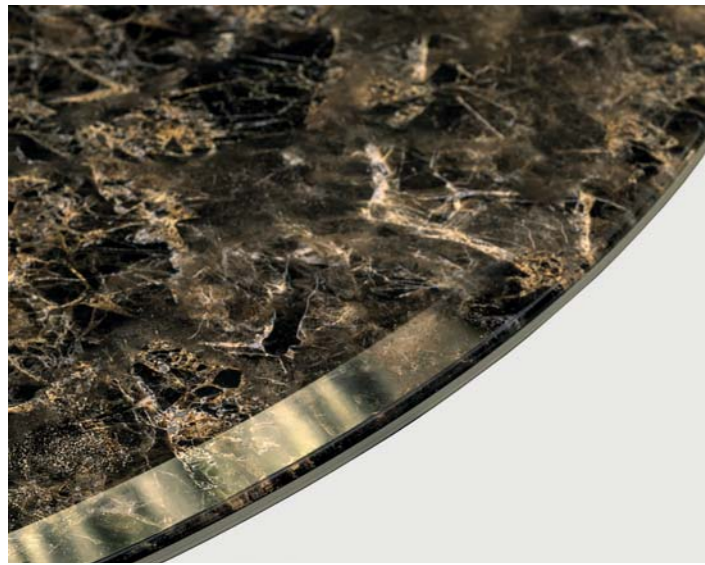

1



2

Caratteristiche principali / Main features

1 Dettaglio del top con bordo biselato realizzato in vetro extrachiario, stampato in digitale con decoro marmo Emperador brown. Per maggiori dettagli sulle caratteristiche di questi vetri, consultare il nostro listino.

Detail of the top with bevelled edge, made of extra-clear glass digital printed with Emperador brown marble decoration. Check our pricelist for more details about features of these glass.

2 Dettaglio del sofisticato vetro bronzo forgiato a caldo con bordo filo lucido piatto. Il vetro bronzo (o grigio fumé) spessore 10 mm viene scaldato fino al punto di fusione a 740° e pressato per ottenere un effetto finemente ondulado che, per specchiatura e trasparenza, richiama la superficie dell'acqua leggermente increspata.

Detail of the sophisticated bronze hot forged glass with flat polished edge. Bronze (or smoke grey) 10 mm glass is heated in an oven at 740°, then pressed to obtain a finely wavy effect, reminding slightly rippled water surface.

3 L'elegante top in vetro bronzo trasparente spessore 10 mm con bordo filo lucido piatto, lascia trasparire l'originale forma di questa base in lamina d'acciaio con finitura bronzo sablé, alla quale è fissato con sofisticate piastre in acciaio di colore nero.

Detail of the elegant round top made of transparent bronze glass 10 mm thick with flat polished edge. It is the version that better enhances the original shape of the steel structure with sandblasted bronze finishing. Top is fixed to the structure by refined black coloured steel plates



3

Dimensioni / Size

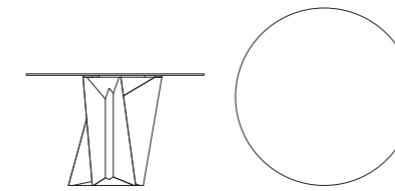

0/850 120.T
cm Ø 120 × h 75

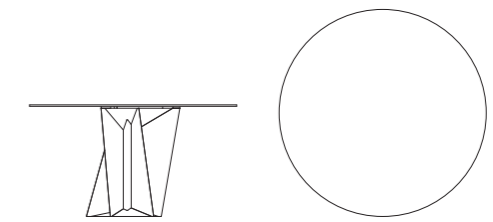

0/850 140.T
cm Ø 140 × h 75

Finiture / Finishes

➔ Colori e combinazioni disponibili nella web app Pezzani
Colors and combinations available in Pezzani's web app

Liverpool

Design: Pezzani

Ita Liverpool è un tavolino trasformabile. Il piano alzabile che nasconde un pratico contenitore trasforma il tavolo basso in un pratico piano di lavoro o svago. Il sistema di sollevamento con movimento a compasso è assistito da pistoni a gas che, oltre a favorire la movimentazione del top, ne frenano ed ammortizzano il peso in fase di chiusura. Il movimento è pratico, solido e funzionale: il top si solleva di 25 cm e si avvicina di ben 35 cm, rendendo agevole il suo utilizzo quando si è comodamente seduti sul divano. La struttura portante in lamina d'acciaio spessore 6 mm è verniciata con finitura sablé, l'elemento contenitore ed il top sono realizzati in laminato ecologico di spessore 18/25 mm. La parte centrale del vano è nascosta dal top quando questo è abbassato, mentre le parti laterali sono aperte e fruibili per riporre oggetti di uso frequente.

En Liverpool is a multipurpose coffee-table. The lift top that hides a practical box, turns the coffee-table into a handy work or leisure surface. The lift system with compass movement is assisted by a gas spring system that makes this movement extremely easy and also brakes and absorbs the weight of the top in its return phase. The lift system is practical, solid and functional: the top lifts up 25 cm and to moves 35 cm in your direction, making it comfortably accessible when sitting on the sofa. Structure is made of sand-blasted coloured steel 6 mm thick, while storage unit and top are made of 18/25 mm eco-friendly laminate. The central part of the storage unit is hidden by the top when in lowered position, whereas the lateral parts are open and can be used to store everyday objects.



Dimensioni / Size

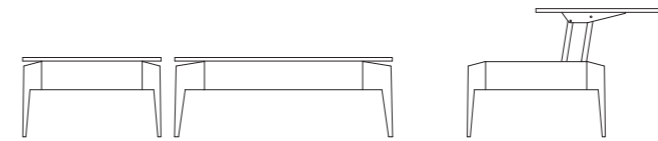

0/268 - Chiuso / Closed
cm 110 × 70 × h 40

Aperto / Open
cm 110 × 70 + 35 × h 65

Finiture / Finishes

→ Colori e combinazioni disponibili nella web app Pezzani
Colors and combinations available in Pezzani's web app





Dafne

Ita Questa elegante poltroncina offre sorprendenti combinazioni di stile. La seduta può essere abbinata a varie basi in metallo verniciate con finitura sablé o cromate, incluse versioni sgabello. Sedile e schienale sono realizzati in legno multistrato di betulla, imbottiti con spugna di poliuretano espanso ad alta densità e ricoperti a scelta con una ampia gamma di tessuti, vera pelle o similpelle. Inoltre la seduta può essere ulteriormente personalizzata, scegliendo l'esterno dello schienale trapuntato oppure colori e materiali diversi tra fronte e retro, creando abbinamenti unici ed esclusivi. Il risultato finale è una sedia costruita su misura in grado di soddisfare ogni esigenza.

En This elegant armchair offers amazing style combinations. You can match the seat with several sandblasted coloured or chrome plated metal frames, including stool versions. Backrest and seat are made of birch plywood, padded with high-density polyurethane foam and upholstered with a wide range of fabric, leather or leatherette at your choice. The seat also offers several customizations, like the quilted back and possibility to choose different colors and materials between front and back, to create unique and exclusive combinations. The final result is a tailor-made chair able to satisfy every need and taste.



S/DAF-12 - similpelle Magic 10 bianco/retro velluto Viky 32 tortora + base Bronzo sablé
/ white leatherette Magic 10/dove grey velvet Viky 32 back + Sandablasted bronze frame



S/DAF-01- similpelle Magic 10/retro velluto Viky 32 + base Cromata
/ leatherette Magic 10/velvet Viky 32 back + Chrome plated base



S/DAF-07 - similpelle Magic 10/retro velluto Viky 32 + base Cromata
/ leatherette Magic 10/velvet Viky 32 back + Chrome plated frame



S/DAF-04 - tessuto Puntino 138 azzurro + base Bronzo sablé
/ light blue fabric Puntino 138 + Sandablasted bronze frame



S-DAF-53 - similpelle Magic 10 bianco/retro velluto Viky 32 tortora + base Nero sablé
/white leatherette Magic 10/dove grey velvet Viky 32 back + Sandblasted black base

Ita Le moderne strutture girevoli degli sgabelli 50 e 53 sono rese particolarmente stabili da una base in ghisa ricoperta da una cover in lamina di acciaio inox collegata al piantone con un pistone a gas di norma cromato, ma che può essere richiesto anche nickel nero (come nella foto sotto o a lato). Sono dotate di poggiatesta e regolabili in altezza da 62 a 78 cm. Lo sgabello con quattro gambe in acciaio tubolare è disponibile in due altezze: la 04SB con seduta a 67 cm perfetta per la cucina, e la 04SA da 77 cm ideale per i banconi altezza bar.

En The modern swivel structures of stools 50 and 53 are very stable thanks to a cast iron base covered by a stainless-steel plate. This base is usually connected to the column by a chrome plated gas lift, but it is also available with the optional black nickel finish (as into the photo below or on the side). The structure is height-adjustable from 62 to 78 cm, and has a footrest. The stool with four legs made of tubular steel is available in two sizes: the 04SB with a 67 cm height seat that is perfect for standard kitchen size, and the 04SA, with seat height 77 cm, is ideal for bar counters.



S/DAF-50 - acquaclean Nordic 904 bordeaux + base Nero sablé
/ wine red acquaclean fabric Nordic 904 + Sandblasted black base



S/DAF-04B - acquaclean Nordic 904 bordeaux + base Nero sablé
/wine red acquaclean Nordic 904 + Sandblasted black frame



1



2

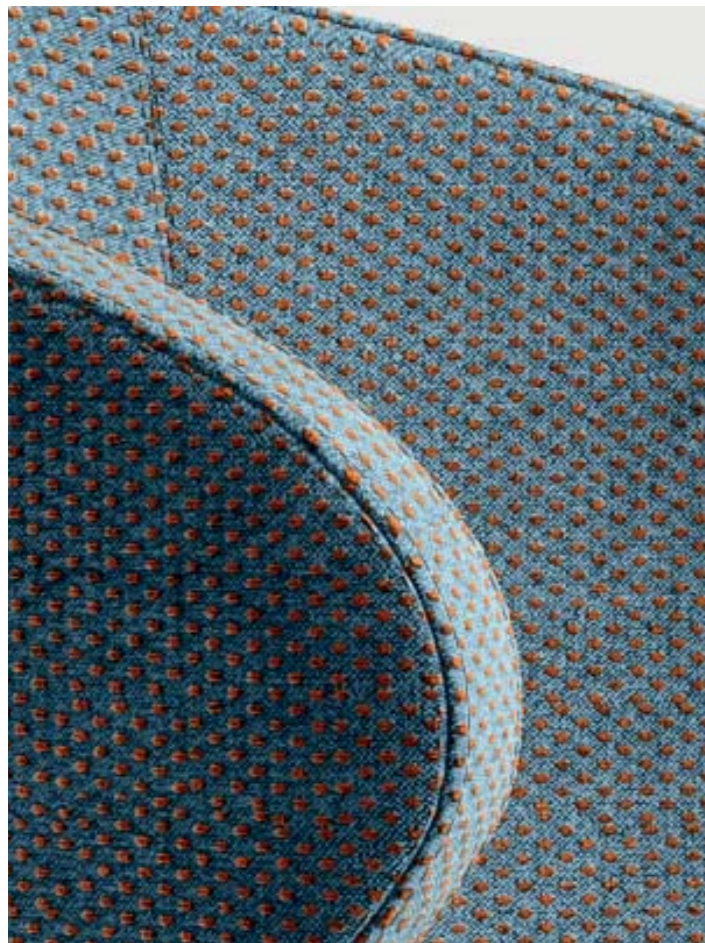

3

Caratteristiche principali / Main features

1 Dettaglio delle cuciture sulle versioni in vera pelle (cat.C) o similpelle di alta qualità (cat A)

Detail of seams on leather (Cat. C) or high quality leatherette (Cat. A).

2 Su richiesta il retro dello schienale della seduta può essere arricchito con trapuntatura opzionale (come da foto) e richiesto in colori e materiali diversi da quello della seduta interna.

For the backrest, we offer several customization possibilities. On demand, you can choose a different colour and material for its back, and also quilted surface (as per photo).

3 Dettaglio del rivestimento in tessuto Puntino 138.

Detail of upholstered seat with fabric Puntino 138.

Dimensioni / Size

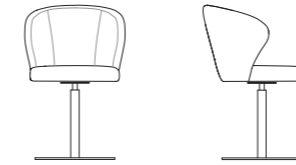

S/DAF - 01
cm 55 × 59 × h 80 (seduta/seat h 49)



S/DAF - 12
cm 55 × 59 × h 80 (seduta/seat h 49)

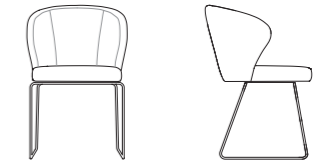

S/DAF - 07
cm 55 × 59 × h 80 (seduta/seat h 49)



S/DAF - 04
cm 55 × 59 × h 80 (seduta/seat h 49)

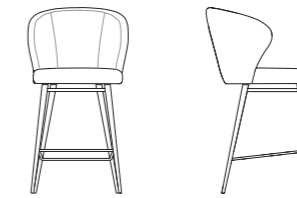

S/DAF - 04SB
cm 55 × 59 × h 98 (seduta/seat h 67)

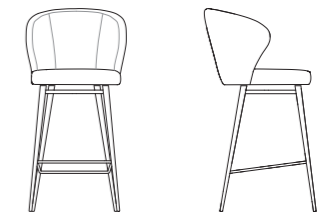

S/DAF - 04SA
cm 55 × 59 × h 108 (seduta/seat h 77)

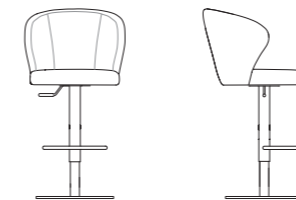

S/DAF - 50
cm 55 × 59 × h 93-109
(seduta/seat h 62-78)

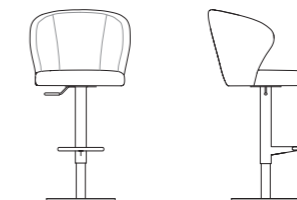

S/DAF - 53
cm 55 × 59 × h 93-109
(seduta/seat h 62-78)

Finiture / Finishes



Colori e combinazioni disponibili nella web app Pezzani
Colors and combinations available in Pezzani's web app

Olimpe



Ita Questa elegante poltroncina offre sorprendenti combinazioni di stile. La seduta può essere abbinata a varie basi in metallo verniciate con finitura sablé o cromate, incluse versioni sgabello. Sedile e schienale sono realizzati in legno multistrato di betulla, imbottiti con spugna di poliuretano espanso ad alta densità e ricoperti a scelta con una ampia gamma di tessuti, vera pelle o similpelle. Inoltre la seduta può essere ulteriormente personalizzata, scegliendo l'esterno dello schienale trapuntato oppure colori e materiali diversi tra fronte e retro, creando abbinamenti unici ed esclusivi. Il risultato finale è una sedia costruita su misura in grado di soddisfare ogni esigenza.

En This elegant armchair offers amazing style combinations. You can match the seat with several sandblasted coloured or chrome plated metal frames, including stool versions. Backrest and seat are made of birch plywood, padded with high-density polyurethane foam and upholstered with a wide range of fabric, leather or leatherette at your choice. The seat also offers several customizations, like the quilted back and possibility to choose different colors and materials between front and back, to create unique and exclusive combinations. The final result is a tailor-made chair able to satisfy every need and taste.



S/OLI-12 - acquaclean Nordic 115 grigio cenere + base Nero sablé
/ ash grey acquaclean Nordic 115 + Sandblasted black frame



S/OLI-01 - acquaclean Nordic 115 grigio cenere + base Cromata
/ ash grey acquaclean Nordic 115 + Chrome plated base



S/OLI-07 - acquaclean Nordic 115 grigio cenere + base Cromata
/ ash grey acquaclean Nordic 115 + Chrome plated frame



S/OLI-04 - acquaclean Nordic 115 grigio cenere/retro Viky 61 grigio cenere + base Nero sablé
/ ash grey acquaclean Nordic 115/ash grey velvet Viky 18 back + Sandblasted black frame



S/OLI-50 - similpelle Magic 57 blu/retro trapuntato + base Cromata
/ blue leatherette Magic 57/quilted back + chrome plated base

Ita Le moderne strutture girevoli degli sgabelli 50 e 53 sono rese particolarmente stabili da una base in ghisa ricoperta da una cover in lamina di acciaio inox collegata al piantone con un pistone a gas di norma cromato, ma che può essere richiesto anche nickel nero (come nella foto sotto riportata). Sono dotate di poggiapiedi e regolabili in altezza da 62 a 78 cm. Lo sgabello con quattro gambe in acciaio tubolare è disponibile in due altezze: la 04SB con seduta a 69 cm perfetta per la cucina, e la 04SA da 79 cm ideale per i banconi altezza bar.

En The modern swivel structures of stools 50 and 53 are very stable thanks to a cast iron base covered by a stainless-steel plate. This base is usually connected to the column by a chrome plated gas lift, but it is also available with the optional black nickel finish (as into the below photo). The structure is height-adjustable from 62 to 78 cm, and has a footrest. The stool with four legs made of tubular steel is available in two sizes: the 04SB with a 69 cm height seat that is perfect for standard kitchen size, and the 04SA, with seat height 79 cm, is ideal for bar counters.



S/OLI-53 - velluto Viky 72 petrolio + base Nero sablé
/ petroleum velvet Viky 72 + Sandblasted Black base



S/OLI-04B - velluto Viky 72 petrolio + base Nero sablé
/ petroleum velvet Viky 72 + Sandblasted Black frame



1



2



3

Caratteristiche principali / Main features

1 Dettaglio delle cuciture sulle versioni in vera pelle (cat.C) o similpelle di alta qualità (cat A)

Detail of seams on leather (Cat. C) or high quality leatherette (Cat. A).

2 Su richiesta il retro dello schienale della seduta può essere arricchito con trapuntatura opzionale (come da foto) e richiesto in colori e materiali diversi da quello della seduta interna.

For the backrest, we offer several customization possibilities. On demand, you can choose a different colour and material for its back, and also quilted surface (as per photo).

3 Su richiesta il retro dello schienale di questa seduta è disponibile in legno multistrati impiallacciato frassino, tinto: naturale, noce, rovere scuro o nero venato.

On demand, the back of this chair is available also made of ash veneered plywood with natural, walnut, dark oak or black veined finishes.

Dimensioni / Size

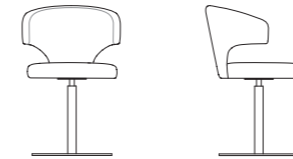

S/OLI - 01
cm 55 × 56 × h 78 (seduta/seat h 49)



S/OLI - 12
cm 55 × 56 × h 78 (seduta/seat h 49)

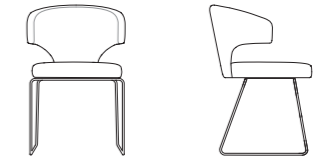

S/OLI - 07
cm 55 × 56 × h 78 (seduta/seat h 49)



S/OLI - 04
cm 55 × 56 × h 78 (seduta/seat h 49)

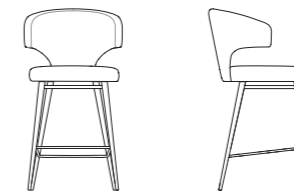

S/OLI - 04SB
cm 55 × 56 × h 98 (seduta/seat h 69)

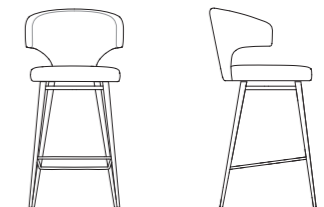

S/OLI - 04SA
cm 55 × 56 × h 108 (seduta/seat h 79)

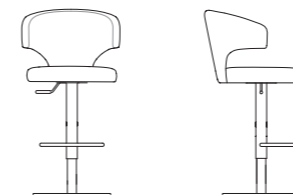

S/OLI - 50
cm 55 × 56 × h 91-107
(seduta/seat h 62-78)

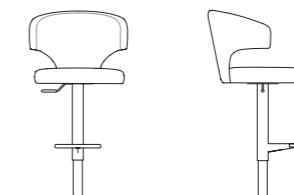

S/OLI - 53
cm 55 × 56 × h 91-107
(seduta/seat h 62-78)

Finiture / Finishes



Colori e combinazioni disponibili nella web app Pezzani
Colors and combinations available in Pezzani's web app



Polly

Ita Questa elegante poltroncina offre sorprendenti combinazioni di stile. La seduta può essere abbinata a varie basi in metallo verniciate con finitura sablé o cromate, incluse versioni sgabello. Sedile e schienale sono realizzati in legno multistrato di betulla, imbottiti con spugna di poliuretano espanso ad alta densità e ricoperti a scelta con una ampia gamma di tessuti, vera pelle o similpelle. Inoltre la seduta può essere ulteriormente personalizzata, scegliendo l'esterno dello schienale trapuntato oppure colori e materiali diversi tra fronte e retro, creando abbinamenti unici ed esclusivi. Il risultato finale è una sedia costruita su misura in grado di soddisfare ogni esigenza.

En This elegant armchair offers amazing style combinations. You can match the seat with several sandblasted coloured or chrome plated metal frames, including stool versions. Backrest and seat are made of birch plywood, padded with high-density polyurethane foam and upholstered with a wide range of fabric, leather or leatherette at your choice. The seat also offers several customizations, like the quilted back and possibility to choose different colors and materials between front and back, to create unique and exclusive combinations. The final result is a tailor-made chair able to satisfy every need and taste.

Ita La seduta può essere abbinata alle strutture in metallo 04 e 12 verniciate con finitura sablé oppure alla struttura girevole cromata 01, resa particolarmente stabile da una base in ghisa ricoperta da una cover in lamina di acciaio inox.

En The seat of this chair can be combined with sand-blasted coloured metal frames 04 and 12 or with the chrome plated swivel structure 01, very stable thanks to a cast iron base covered by a stainless-steel plate.



S/POL-12 - tessuto Caliente 03 verde + base Nero sablé
/ green fabric Caliente 03 + Sandblasted black frame



S/POL-01 - tessuto Caliente 03 verde + base Cromata
/ green fabric Caliente 03 + Chrome plated base

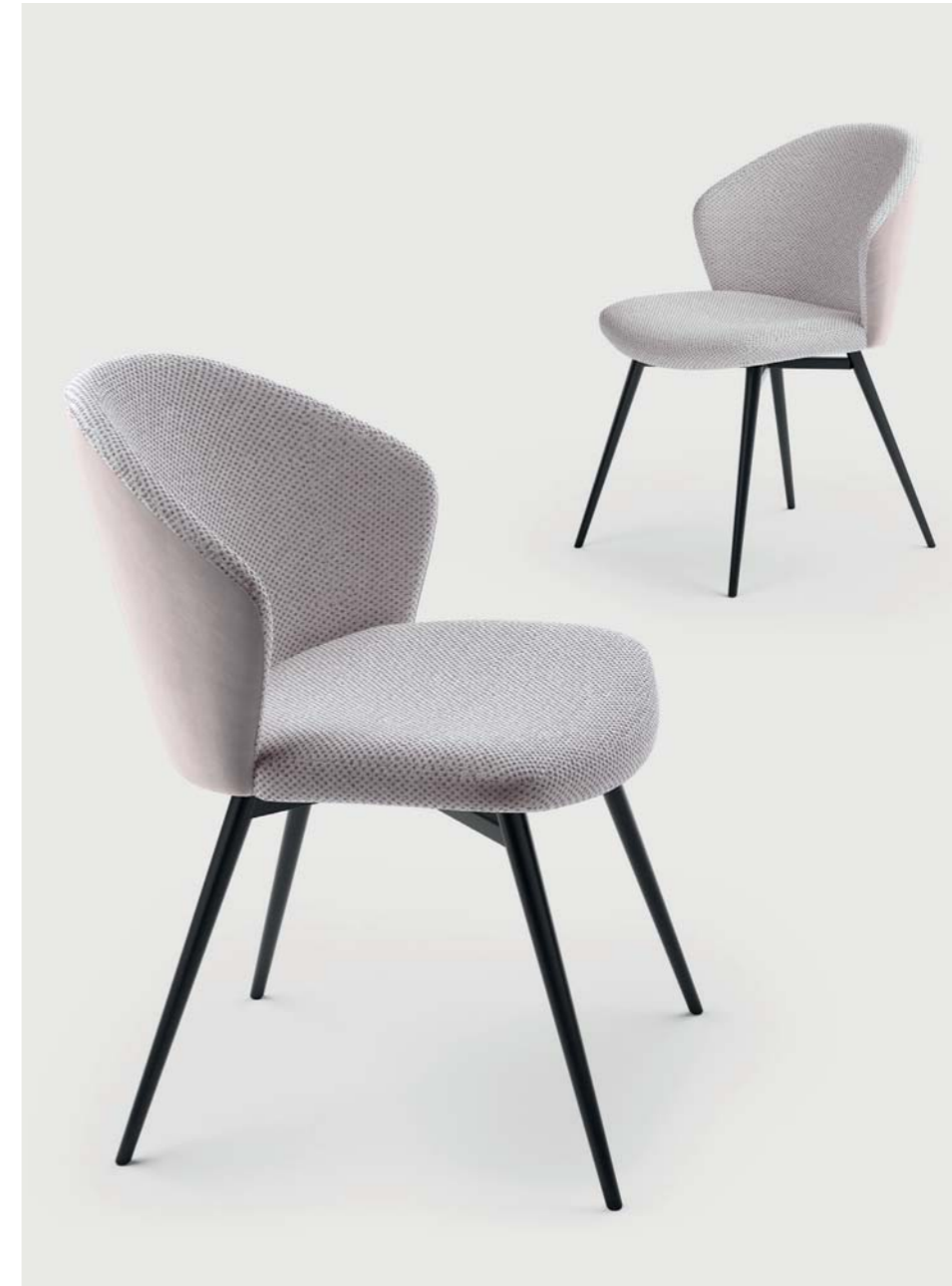

S/POL-04 - tessuto Puntino 122 ecru/retro velluto Viky 18 rosa cipria + base Nero sablé
/ ecru fabric Puntino 122/pink velvet Viky 18 back + Sandblasted black frame



S/POL-04SB - tessuto acquaclean Nordic 115 grigio cenere + base Nero sablé
/ ash grey acquaclean fabric Nordic 115 + Sandblasted black frame

Ita Le moderne strutture girevoli degli sgabelli 50 e 53 sono rese particolarmente stabili da una base in ghisa ricoperta da una cover in lamina di acciaio inox collegata al piantone con un pistone a gas di norma cromato, ma che può essere richiesto anche nickel nero (come nelle foto sotto riportate). Sono dotate di poggiapiedi e regolabili in altezza da 62 a 78 cm. Lo sgabello con quattro gambe in acciaio tubolare è disponibile in due altezze: la 04SB con seduta a 64 cm perfetta per la cucina, e la 04SA da 74 cm ideale per i banconi altezza bar.

En The modern swivel structures of stools 50 and 53 are very stable thanks to a cast iron base covered by a stainless-steel plate. This base is usually connected to the column by a chrome plated gas lift, but it is also available with the optional black nickel finish (as into the below photos). The structure is height-adjustable from 62 to 78 cm, and has a footrest. The stool with four legs made of tubular steel is available in two sizes: the 04SB with a 64 cm height seat that is perfect for standard kitchen size, and the 04SA, with seat height 74 cm, is ideal for bar counters.



S/POL-53 - velluto Viky 72 petrolio + base Nero sablé
/ petroleum velvet Viky 72 + Sandblasted Black base



S/POL-50 - velluto Viky 72 petrolio + base Nero sablé
/ petroleum velvet Viky 72 + Sandblasted Black base



1



2



3

Caratteristiche principali / Main features

1

Su richiesta il retro dello schienale della seduta può essere arricchito con trapuntatura opzionale (come da foto) e richiesto in colori e materiali diversi da quello della seduta interna.

For the backrest, we offer several customization possibilities. On demand, you can choose a different colour and material for its back, and also quilted surface (as per photo).

2

Dettaglio delle cuciture sulle versioni in vera pelle (cat.C) o similpelle di alta qualità (cat A)

Detail of seams on leather (Cat. C) or high quality leatherette (Cat. A).

3

Dettaglio dello sgabello con struttura a quattro gambe in acciaio tubolare (articolo 04SA)

Detail of the stool with four legs frame made of tubular steel (item 04SA)

Dimensioni / Size

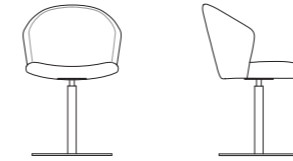

S/POL - 01
cm 53 × 57 × h 80 (seduta/seat h 47)



S/POL - 12
cm 53 × 57 × h 80 (seduta/seat h 47)



S/POL - 04
cm 53 × 57 × h 80 (seduta/seat h 47)

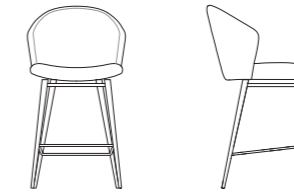

S/POL - 04SB
cm 53 × 57 × h 102 (seduta/seat h 64)

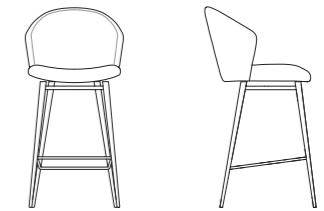

S/POL - 04SA
cm 53 × 57 × h 112 (seduta/seat h 74)

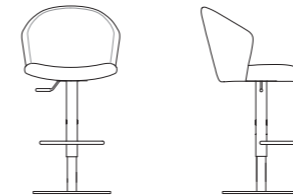

S/POL - 50
cm 53 × 57 × h 95-111
(seduta/seat h 62-78)

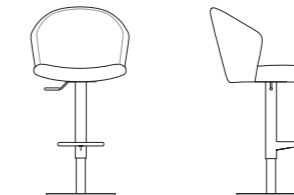

S/POL - 53
cm 53 × 57 × h 95-111
(seduta/seat h 62-78)

Finiture / Finishes



Colori e combinazioni disponibili nella web app Pezzani
Colors and combinations available in Pezzani's web app

Minerva



Ita Questa elegante poltroncina offre sorprendenti combinazioni di stile. La seduta può essere abbinata a varie basi in metallo verniciate con finitura sablé o cromate, incluse versioni sgabello. Sedile e schienale sono realizzati in legno multistrato di betulla, imbottiti con spugna di poliuretano espanso ad alta densità e ricoperti a scelta con una ampia gamma di tessuti, vera pelle o similpelle. Inoltre la seduta può essere ulteriormente personalizzata, scegliendo l'esterno dello schienale trapuntato oppure colori e materiali diversi tra fronte e retro, creando abbinamenti unici ed esclusivi. Il risultato finale è una sedia costruita su misura in grado di soddisfare ogni esigenza.

En This elegant armchair offers amazing style combinations. You can match the seat with several sandblasted coloured or chrome plated metal frames, including stool versions. Backrest and seat are made of birch plywood, padded with high-density polyurethane foam and upholstered with a wide range of fabric, leather or leatherette at your choice. The seat also offers several customizations, like the quilted back and possibility to choose different colors and materials between front and back, to create unique and exclusive combinations. The final result is a tailor-made chair able to satisfy every need and taste.



S/MIN-12 - velluto Viky 18 rosa cipria + base Nero sablé
/ pink velvet Viky 18 + Sandblasted black frame



S/MIN-01 - velluto Viky 18 rosa cipria + base Cromata
/ pink velvet Viky 18 + Chrome plated base



S/MIN-07 - velluto Viky 18 rosa cipria + base Cromata
/ pink velvet Viky 18 + Chrome plated frame



S/MIN-04 - tessuto Miele 36 grigio bruno + base Nero sablé
/ grey brown fabric Miele 36 + Sandblasted black frame



S/MIN-04SB - Pelle PL 33 corda + base Nero sablé
/ rope Leather PL 33 + Sandblasted black frame

Ita Le moderne strutture girevoli degli sgabelli 50 e 53 sono rese particolarmente stabili da una base in ghisa ricoperta da una cover in lamina di acciaio inox collegata al piantone con un pistone a gas di norma cromato, ma che può essere richiesto anche nickel nero. Sono dotate di poggiatesta e regolabili in altezza da 62 a 78 cm. Lo sgabello con quattro gambe in acciaio tubolare è disponibile in due altezze: la 04SB con seduta a 67 cm perfetta per la cucina, e la 04SA da 77 cm ideale per i banconi altezza bar.

En The modern swivel structures of stools 50 and 53 are very stable thanks to a cast iron base covered by a stainless-steel plate. This base is usually connected to the column by a chrome plated gas lift, but it is also available with the optional black nickel finish. The structure is height-adjustable from 62 to 78 cm, and has a footrest. The stool with four legs made of tubular steel is available in two sizes: the 04SB with a 67 cm height seat that is perfect for standard kitchen size, and the 04SA, with seat height 77 cm, is ideal for bar counters.



S/MIN-53 - Pelle PL 33 corda + base Cromata
/ rope Leather PL 33 + Chrome plated base



S/MIN-50 - Pelle PL 33 corda + base Cromata
/ rope Leather PL 33 + Chrome plated base



1



2

Caratteristiche principali / Main features

1 Dettagli delle cuciture nelle versioni in vera pelle (cat.C) o similpelle (cat A)

Detail of seams on leather (Cat. C) or high quality leatherette (Cat. A).

2 Dettaglio del rivestimento in tessuto Miele 36.

Detail of upholstered seat with Miele 36 fabric.

Dimensioni / Size

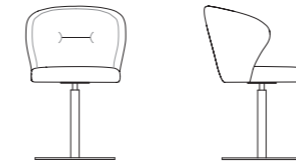

S/MIN - 01
cm 55 × 59 × h 80 (seduta/seat h 49)

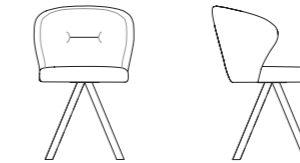

S/MIN - 12
cm 55 × 59 × h 80 (seduta/seat h 49)

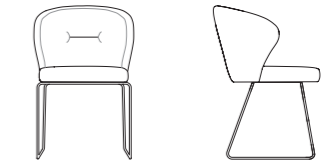

S/MIN - 07
cm 55 × 59 × h 80 (seduta/seat h 49)

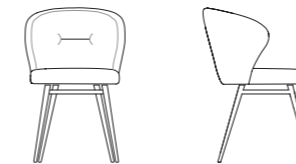

S/MIN - 04
cm 55 × 59 × h 80 (seduta/seat h 49)

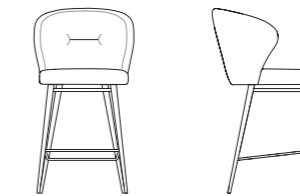

S/MIN - 04SB
cm 55 × 59 × h 98 (seduta/seat h 67)

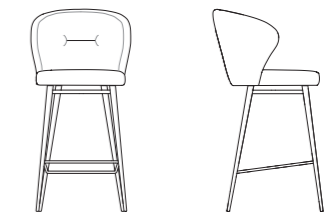

S/MIN - 04SA
cm 55 × 59 × h 108 (seduta/seat h 77)

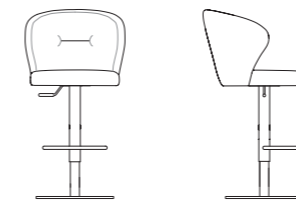

S/MIN - 50
cm 55 × 59 × h 93-109
(seduta/seat h 62-78)

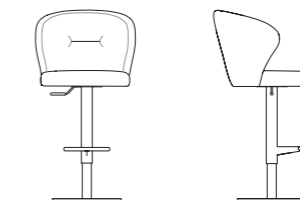

S/MIN - 53
cm 55 × 59 × h 93-109
(seduta/seat h 62-78)

Finiture / Finishes

→ Colori e combinazioni disponibili nella web app Pezzani
Colors and combinations available in Pezzani's web app



Medea

Ita Questa elegante poltroncina offre sorprendenti combinazioni di stile. La seduta può essere abbinata a varie basi in metallo verniciate con finitura sablé o cromate, inclusa la versione sgabello. La scocca è realizzata in polipropilene, imbottita con spugna di poliuretano espanso ad alta densità e ricoperta a scelta con una ampia gamma di tessuti, vera pelle o similpelle. Sul retro dello schienale si può chiedere la lavorazione trapuntata per creare abbinamenti unici ed esclusivi. Il risultato finale è una sedia costruita su misura in grado di soddisfare ogni esigenza.

En This elegant armchair offers amazing style combinations. You can match the seat with several sandblasted coloured or chrome plated metal frames, including a stool version. The shell is made of polypropylene, padded with high-density polyurethane foam and upholstered with a wide range of fabric, leather or leatherette at your choice. On demand, for its back, you can choose quilted surface, to create unique and exclusive combinations. The final result is a tailor-made chair able to satisfy every need and taste.

Ita La seduta può essere abbinata alle strutture in metallo 04M e 12 verniciate con finitura sablé oppure alla struttura girevole cromata 01, resa particolarmente stabile da una base in ghisa ricoperta da una cover in lamina di acciaio inox.

En The seat of this chair can be combined with sandblasted coloured metal frames 04M and 12 or with the chrome plated swivel structure 01, very stable thanks to a cast iron base covered by a stainless-steel plate.



S/MED-12 - velluto Viky 93 verde + base Nero sablé
/ green velvet Viky 93 + Sandablasted black frame



S/MED-01- velluto Viky 93 verde + base Cromata
/ green velvet Viky 93 + Chrome plated base



S/MED-04M - tessuto Miele 11 ecru + base Nero sablé
/ ecru fabric Miele 11 + Sandablasted black frame





1



2

Caratteristiche principali / Main features

1

Su richiesta il retro dello schienale della seduta può essere arricchito con trapuntatura opzionale.

On demand we supply quilted surfaces on the back side of chair's back.

2

Dettaglio del rivestimento in velluto Viky 93

Detail of upholstered seat with Viky 93 velvet.

3

Dettaglio del rivestimento in tessuto Miele 11.

Detail of upholstered seat with Miele 11 fabric.



3

Dimensioni / Size

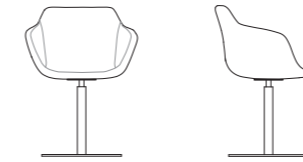

S/MED - 01
cm 61 × 53 × h 81 (seduta/seat h 46)



S/MED - 12
cm 61 × 53 × h 81 (seduta/seat h 46)

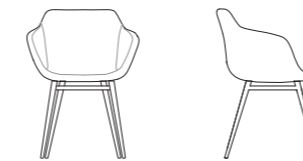

S/MED - 04M
cm 61 × 53 × h 81 (seduta/seat h 46)

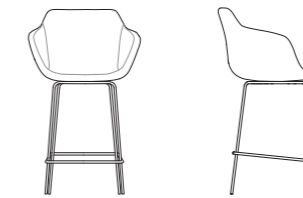

S/MED - SB
cm 61 × 53 × h 99 (seduta/seat h 67)

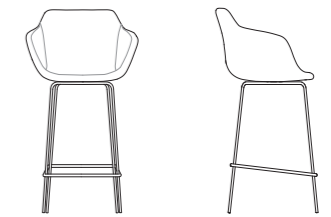

S/MED - SA
cm 61 × 53 × h 109 (seduta/seat h 77)

Finiture / Finishes



Colori e combinazioni disponibili nella web app Pezzani
Colors and combinations available in Pezzani's web app

Morgana

Ita La poltroncina Morgana è una versione più ampia e confortevole della poltroncina Medea che richiama in molti aspetti del design. La seduta può essere abbinata a varie basi in metallo verniciate con finitura sablé o cromate. La scocca è realizzata in polipropilene, imbottita con spugna di poliuretano espanso ad alta densità e ricoperta a scelta con una ampia gamma di tessuti, vera pelle o similpelle. Sul retro dello schienale si può chiedere la lavorazione trapuntata per creare abbinamenti unici ed esclusivi. Il risultato finale è una sedia costruita su misura in grado di soddisfare ogni esigenza.

En Morgana armchair is a wider and more comfortable version of Medea armchair that recalls in many aspects of its design. You can match the seat with several sandblasted coloured or chrome plated metal frames. The shell is made of polypropylene, padded with high-density polyurethane foam and upholstered with a wide range of fabric, leather or leatherette at your choice. On demand, for its back, you can choose quilted surface, to create unique and exclusive combinations. The final result is a tailor-made chair able to satisfy every need and taste.



S/MOR-04M - tessuto acquaclean Nordic 904 bordeaux + base Nero sablé
/ wine red acquaclean fabric Nordic 904 + Sandblasted black frame



S/MOR-01 - Nordic 115 cenere + base Cromata
/ ash grey Nordic 115 + Chrome base



S/MOR-12 - acquaclean Nordic 115 cenere + base Nero sablé
/ ash grey acquaclean Nordic 115 + Black frame



1



Caratteristiche principali / Main features

1

Su richiesta il retro dello schienale della seduta può essere arricchito con trapuntatura opzionale.

On demand we supply quilted surfaces on the back side of chair's back.

2

Dettagli delle cuciture sul retro dello schienale nelle versioni in vera pelle (cat.C) o similpelle (cat A)

Detail of seams on leather (Cat. C) or high quality leatherette (Cat. A).

3

Dettaglio del rivestimento in tessuto Miele 36.

Detail of upholstered seat with Miele 36 fabric.



3

Dimensioni / Size

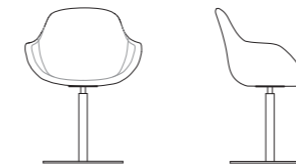

S/MOR - 01
cm 65 × 53 × h 82 (seduta/seat h 45)



S/MOR - 12
cm 65 × 53 × h 82 (seduta/seat h 45)

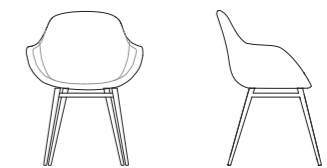

S/MOR - 04
cm 65 × 53 × h 82 (seduta/seat h 45)

Finiture / Finishes



Colori e combinazioni disponibili nella web app Pezzani
Colors and combinations available in Pezzani's web app



Alissa

Design: Pezzani

Ita Questa confortevole sedia ha il sedile realizzato in laminato con imbottitura in spugna di poliuretano espanso ad alta densità, ricoperto a scelta con una ampia gamma di tessuti, vera pelle o similpelle. Inoltre la seduta può essere ulteriormente personalizzata, scegliendo l'esterno dello schienale trapuntato oppure colori e materiali diversi tra fronte e retro, creando abbinamenti unici ed esclusivi. La struttura è in tubolare d'acciaio tondo conificato e verniciato sablé ed è disponibile anche la versione sgabello.

En This very comfortable chair has a seat made of wood laminate, padded with high-density polyurethane foam and upholstered with a wide range of fabric, leather or leatherette at your choice. The seat also offers several customizations, like the quilted back and possibility to choose different colors and materials between front and back, to create unique and exclusive combinations. The frame is made of sandblasted colored round tubular steel and also a stool versions is available.



S/ALI - 00 tessuto Puntino 110 ecru + base Nero sablé
/ ecru fabric Puntino 110 + Sandblasted black frame



S/ALI-SB - tessuto Nordic 115 grigio cenere + base Nero sablé
/ ash grey fabric Nordic 115 + Sandblasted black frame



1

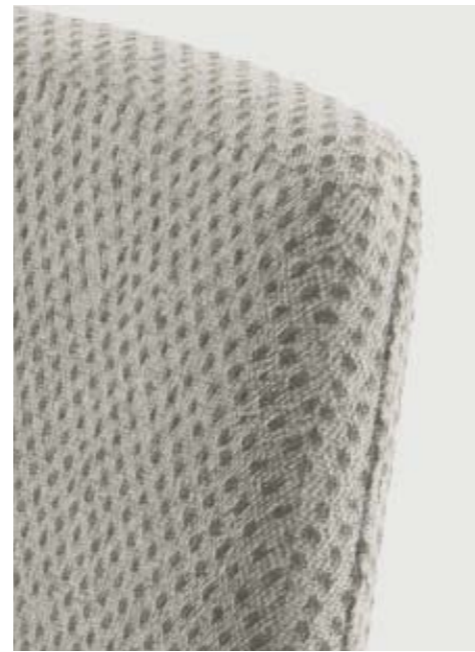

Caratteristiche principali / Main features

1

Dettagli dei rivestimenti in tessuto Miele 36 e Puntino 110 (cat B)

Details of upholstered seat with Miele 36 and puntino 110 fabrics.

2

Dettagli delle cuciture sul retro dello schienale nelle versioni in vera pelle (cat.C) o similpelle (cat A)

Details of the seams on the back of a chair made of leather (Cat. C) or high quality leatherette (Cat. A).



2

Dimensioni / Size

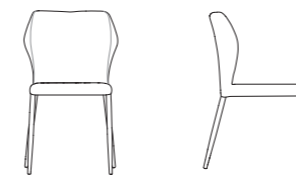

S/ALI - 00
cm 53 × 52 × h 85 (seduta/seat h 49)

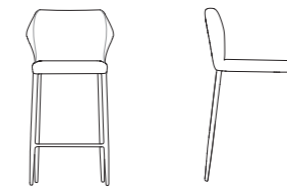

S/ALI - SB
cm 41 × 41 × h 93 (seduta/seat h 66)

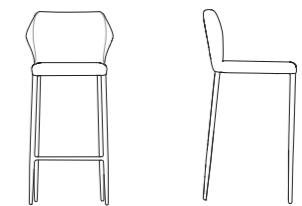

S/ALI - SA
cm 41 × 41 × h 103 (seduta/seat h 76)

Finiture / Finishes



Colori e combinazioni disponibili nella web app Pezzani
Colors and combinations available in Pezzani's web app

Ita Questa confortevole sedia ha il sedile realizzato in laminato con imbottitura in spugna di poliuretano espanso ad alta densità, ricoperto a scelta con una ampia gamma di tessuti, vera pelle o similpelle. Inoltre la seduta può essere ulteriormente personalizzata, scegliendo l'esterno dello schienale trapuntato oppure colori e materiali diversi tra fronte e retro, creando abbinamenti unici ed esclusivi. La struttura è in tubolare d'acciaio tondo conificato e verniciato sablé.

En This very comfortable chair has a seat made of wood laminate, padded with high-density polyurethane foam and upholstered with a wide range of fabric, leather or leatherette at your choice. The seat also offers several customizations, like the quilted back and possibility to choose different colors and materials between front and back, to create unique and exclusive combinations. The frame is made of sandblasted colored round tubular steel.



Dimensioni / Size

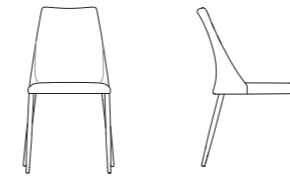

S/CIR-00
cm 50 × 49 × h 90 (seduta/seat h 47)

Finiture / Finishes

→ Colori e combinazioni disponibili nella web app Pezzani
Colors and combinations available in Pezzani's web app



Pezzani srl
Via Papini 33
43036 Fidenza, Parma (Italy)

T +39 0524 525440
info@pezzani.eu
www.pezzani.eu

📸 @pezzaniofficial
f /pezzaniofficial
📍 /pezzani_official

Art direction and Graphic design
Pezzani creative department

Photography
Federico Villa

Styling
Sara Dassi

Digital rendering
Arché agency

Aknowledgments
Antikamente
Artemide
Danese
Enrico Donadello
Giorgio Basfi

Printing
Grafiche Sagi

L'azienda si riserva il diritto di modificare od eliminare gli articoli contenuti in questo catalogo in qualsiasi momento senza preavviso. L'azienda è proprietaria esclusiva del catalogo e del materiale fotografico in essa contenuto; riproduzione vietata. I colori riportati nel catalogo sono solo indicativi e possono differire da quelli reali degli oggetti ai quali si riferiscono. I prodotti riportati in questo catalogo sono principalmente adatti all'uso domestico. Decliniamo ogni responsabilità per danni causati dall'utilizzo diverso o erroneo dei prodotti stessi. Eventuali imperfezioni della lavorazione e della pelle, come variazioni della grana ed altri segni, pieghe e striature, sono da considerarsi caratteristiche dell'unicità del prodotto. È inoltre normale che le imbottiture interne perdano densità con l'uso.

The company has the right to change or delete items from this catalogue without notice. Copyright notice: the company is the sole owner of this catalogue and its pictures; copies are strictly prohibited. The colors of this catalogue are only approximate, they can be different from the real ones. The products included in this catalogue are mainly meant for a domestic use. We declines all responsibility for any damage caused by their misuse or abuse. The used hides display unique characteristics including signs of creasing and stretching, grain variation and other markings. It is normal for interiors to lose density from use.



