

# Crafted Design

— since 1965 —

**GURIAN**



**GURIAN**





# INDEX

## COLLEZIONE \_ COLLECTION

### DIVANI \_ SOFAS

08 – Grand Rest  
20 – Rest  
26 – Recital  
34 – Bloom  
44 – Softy  
52 – Blouson  
62 – Plumy  
72 – Reverso  
82 – Ocean  
94 – Algrave  
108 – Opium  
116 –Lungarno  
128 –Downtown  
140 –Ritmo  
150 –Metropol  
160 –Open Space  
168 –Swing

### POLTRONE \_ ARMCHAIRS

176 – Astro  
178 – Shisha  
180 – Kelly  
184 – Mimi  
188 – Vintage  
192 – Dada  
194 – Marlon  
196 – Britte  
198 – Sofia  
200 – Polly  
202 – Harper  
204 – Fred  
206 – Charlie  
208 – Eliot



## L'AZIENDA THE COMPANY



Crescere significa riempire la distanza tra il passato e il futuro, accumulare ricordi per avere nuovi desideri, affrontare nuove sfide. Solo riconoscendo la nostra storia possiamo continuare ad essere innovativi. La storia del gruppo gurian è in questo senso emblematica e la ricorrenza dei 50 anni ha rappresentato al tempo stesso un traguardo importante e un nuovo punto di partenza. Nato nel 1965 come un laboratorio artigianale, il gruppo Gurian si è sviluppato negli anni fino a diventare un'azienda industriale riconosciuta e presente a livello internazionale: un marchio esclusivamente italiano per clienti cosmopoliti.



*What does progress mean? Progress means bridging the gap between the past and the future, it means gathering memories to fashion desires, and facing up to new challenges. It is only by appreciating our history that can we continue to innovate. In this sense, the history of the Gurian group is emblematic, and our 50th anniversary represents both an important goal and a new starting point. Founded in 1965 as an artisan workshop, the Gurian group gradually developed over the years and became a renowned industrial company on an international scale. We are an exclusively Italian brand for cosmopolitan clients.*

## MANUALITÀ-TECNOLOGIA CRAFTSMANSHIP - TECHNOLOGY

Il "Made in Italy" Gurian non è solo una connotazione geografica ma una scelta imprenditoriale, che genera un sapiente equilibrio tra accuratezza artigianale e precisione tecnologica. La tecnologia permette di sviluppare soluzioni innovative rivolte al miglioramento del comfort e dei processi produttivi industriali. Le competenze artigianali specializzate garantiscono la qualità dell'human touch e un meticoloso controllo. Il prodotto mantiene così, all'interno di una struttura tecnologicamente avanzata, un concetto sartoriale curato nei minimi dettagli.



*The authentically Italian quality of Gurian's brand is not simply a feature of geography but also a business decision, it is the result of an intelligent balance between careful craftsmanship and precision technology. Technology allows us to develop innovative solutions aimed at improving well-being and our industrial production processes. The specialised skills of our craftsmen guarantee the quality of a human touch and meticulous control. Within a technologically advanced environment, the product still preserves a more sartorial ethos that is nurtured in every last detail.*



## MATERIALI MATERIALS

Ogni materiale utilizzato è selezionato e controllato sulla base di alti standard qualitativi. Le strutture sono progettate utilizzando intelaiature in legno e metallo seguendo un attento studio delle sollecitazioni.

Tutte le parti rigide della struttura sono ricoperte da poliuretano espanso per garantire la migliore ergonomia. I cuscini di seduta e schienale sono realizzati in diverse varianti di poliuretano espanso, piuma o ovatta acrilica per ottenere il comfort ed il design richiesto dal progetto. Ogni cucitura, che si tratti di pelle o tessuto, viene realizzata con fili 100% poliammide ad altissima resistenza che ne garantiscono la tenuta e la resa estetica.



*Every material that we used is selected and controlled on the basis of high quality standards. Our furniture is designed using wooden and metal frames, with very careful research of all the stresses involved. All the rigid elements of our products are covered with polyurethane foam to ensure the most ergonomic solution. The seat and back cushions are made in different types of polyurethane foam, feathered or acrylic wadding, in order to obtain the comfort and design that the project requires. Every seam, be it leather or fabric, is made from 100% polyamide high resistant yarns that ensure proper sealing and an aesthetic effect.*

## RIVESTIMENTI UPHOLSTERIES

La collezione Gurian propone un'ampia scelta di rivestimenti in pelle e tessuto. La lavorazione della pelle rappresenta da sempre il principale know-how dell'azienda. Le pelli fiore, conciate in Italia, sono selezionate secondo un attento studio delle esigenze tecniche ed estetiche richieste dal centro ricerca e sviluppo Gurian. Ogni tipo di pelle è unico nelle sue caratteristiche dalla grana, alla morbidezza, allo spessore ed alla finitura. I tessuti, realizzati in esclusiva nelle migliori tessiture italiane, propongono una scelta completa in colori e trame.

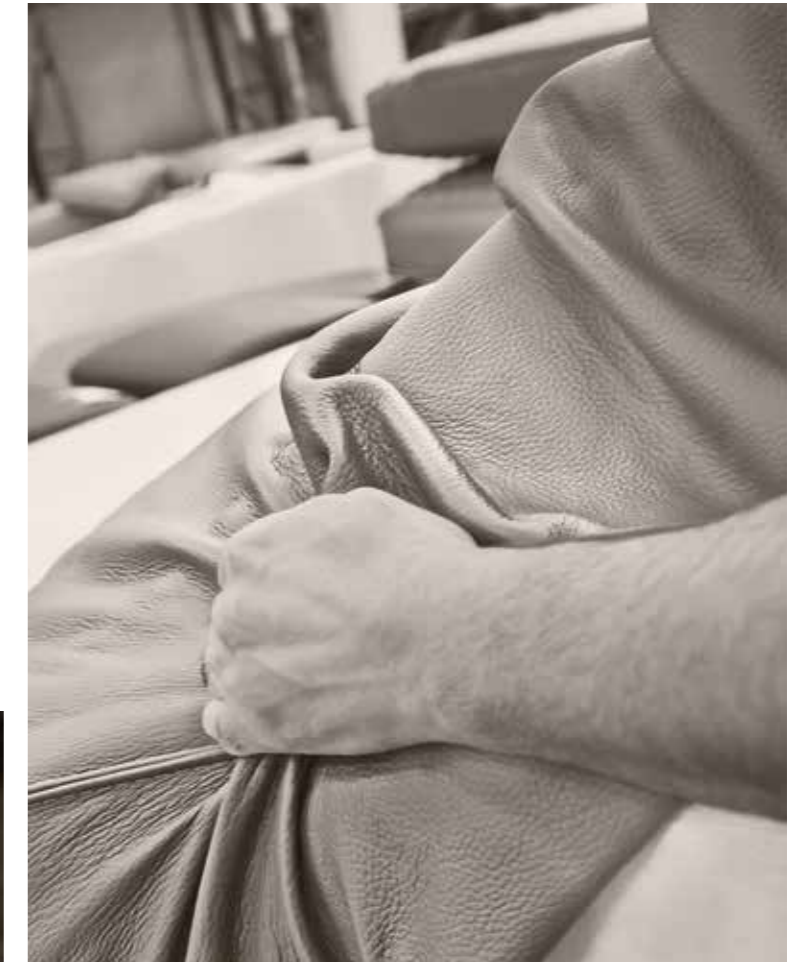

*The Gurian collection offers a wide choice of leather and fabric upholstery. Our method of working with leather has always been our foremost area of expertise. The full grain leathers, tanned in Italy, are selected according to a meticulous research of the technical and aesthetic requirements demanded by our research and development centre. Each type of leather is unique in its grain characteristics, softness, thickness and quality finish. Our fabrics, made exclusively from the best Italian material, offer a complete range of colours and textures.*



## GRAND REST

Un progetto di alta personalizzazione. Un modello dove eleganza, comodità e tecnologia si fondono. I cuscini di schiena poggiano su un particolarissimo meccanismo che consente di scegliere tra due altezze, ottenendo così comfort unico nel suo genere. "Grand Rest" è il risultato di un intelligente progetto creativo, dove versatilità e qualità sono gli elementi cardine.

*A highly customisable design. A model in which elegance, comfort and technology come together. The back cushions rest on a very unusual mechanism that allows you to choose between two heights, resulting in a unique form of comfort.*

*"Grand Rest" is the result of an intelligent creative project in which versatility and quality form the key elements uncluttered lines.*





















## SCHEDA TECNICA

**Imbottitura:** base rivestita in poliuretano espanso. Schiena e bracciolo in poliuretano espanso indeformabile a densità differenziata ricoperto da falda acrilica. Cuscino di seduta in poliuretano espanso indeformabile a densità differenziata ricoperto da foderina in latex canalizzata. Fodera 100% cotone. Cuscino di schiena in latex canalizzata con inserto in poliuretano espanso indeformabile a densità differenziata. Fodera 100% cotone.

**Struttura:** intelaiatura in legno di varie essenze e molleggio con cinghie elastiche incrociate, interamente ricoperte e con anima in polipropilene.

**Rivestimento:** tessuto e/o pelle.

**Sfoderabilità:** totale nella versione in tessuto.

**Piedi:** legno massello verniciato con antiscivolo.

**Caratteristica:** è possibile personalizzare il proprio comfort attraverso un meccanismo manuale che permette di variare l'altezza dello schienale. Inoltre, la componibilità si completa nella scelta di complementi integrati al modello (bracciolo e tavolino).

## TECH SHEET

**Padding:** base covered with polyurethane foam. Backrest and armrest in different density non-deforming polyurethane foam coated with acrylic padding. Seat cushion in different density non-deforming polyurethane foam coated with channeled latex. Lining 100% cotton. Back cushion in channeled latex and different density non-deforming polyurethane foam core. Lining 100% cotton.

**Structure:** frame in different kinds of wood and support with interwoven elastic webbing, completely covered and reinforced with polypropylene.

**Upholstery:** fabric or leather.

**Removable covers:** fully removable covers in fabric.

**Feet:** varnished solid wood with non-slip.

**Feature:** you can customize your comfort through a manual mechanism which allows to vary the height of the back cushion. Furthermore, the combination between the elements and the accessories integrated with the model (armrest and table).

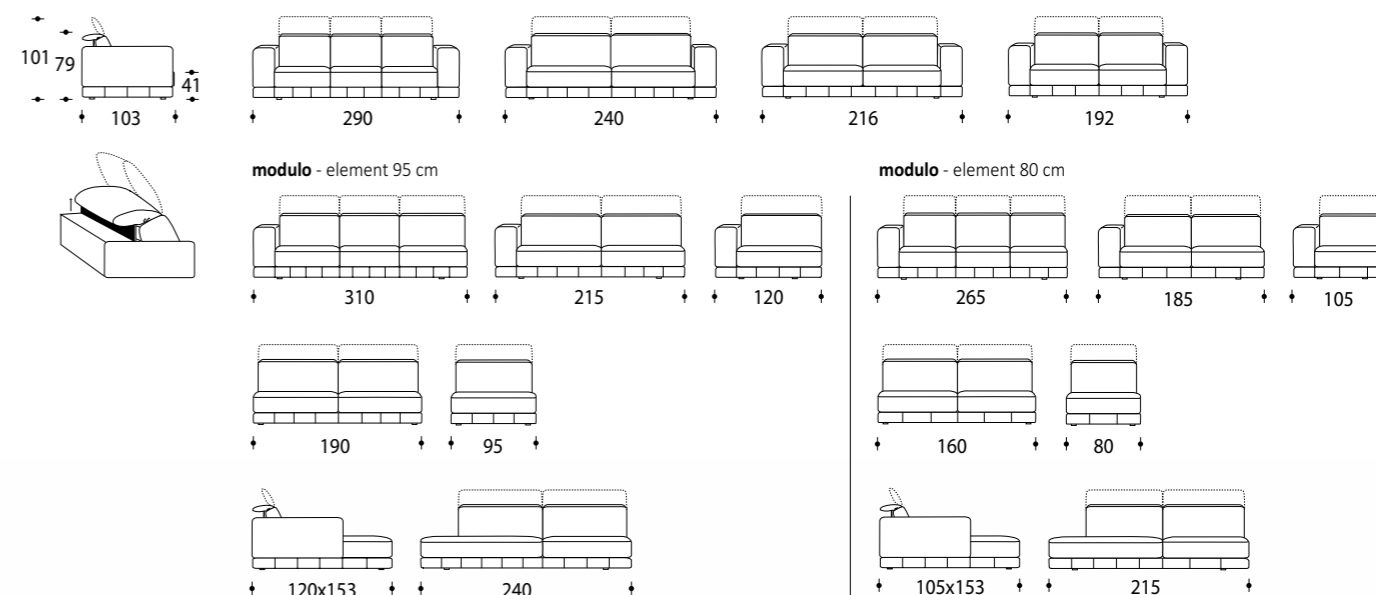
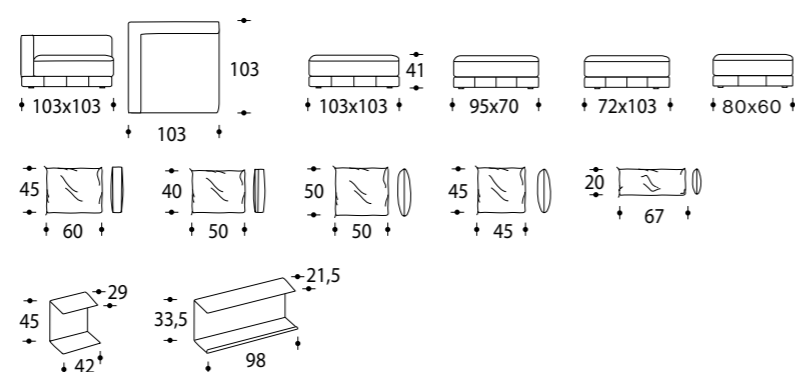

• GRAND REST (divano componibile / modular sofa system) – L/W413 × P/D390 × H79/101 cm –

tessuto/fabric: Cat. F Barbat 18 col.02



## REST

Un modello dove il valore di un salotto di prestigio si traduce in eccellente qualità ed indiscussa comodità. La sobria eleganza si arricchisce di precisi dettagli da personalizzare, per dare unicità al proprio progetto. Nuove soluzioni di spazio living possono nascere dall'ampia componibilità e dagli accessori integrati al modello. Rest è una conferma assoluta del fascino italiano.

*A model that translates the value of a prestigious lounge into excellent quality and undisputed comfort. Simple elegance is enriched with precise details that are customised to add unique flair to the design. New living space solutions can arise from the wide variety of combinable components and accessories integrated with the model. Rest provides absolute confirmation of Italian allure.*









## SCHEDATECNICA

**Imbottitura:** base rivestita in poliuretano espanso. Schiena e bracciolo in poliuretano espanso indeformabile a densità differenziata ricoperto da falda acrilica. Cuscino di seduta in poliuretano espanso indeformabile a densità differenziata ricoperto da foderina in latex canalizzata. Fodera 100% cotone. Cuscino di schiena in latex canalizzata con inserto in poliuretano espanso indeformabile a densità differenziata. Fodera 100% cotone.

**Struttura:** intelaiatura in legno di varie essenze e molleggio con cinghie elastiche incrociate, interamente ricoperte e con anima in polipropilene.

**Rivestimento:** tessuto e/o pelle.

**Sfoderabilità:** totale nella versione in tessuto.

**Piedi:** legno massello verniciato con antiscivolo.

**Caratteristica:** la componibilità che si completa nella scelta di complementi integrati al modello (bracciolo e tavolino).

## TECH SHEET

**Padding:** base covered with polyurethane foam. Backrest and armrest in different density non-deforming polyurethane foam coated with acrylic padding. Seat cushion in different density non-deforming polyurethane foam coated with channeled latex. Lining 100% cotton. Back cushion in channeled latex and differnt density non-deforming polyurethane foam core. Lining 100% cotton.

**Structure:** frame in different kinds of wood and support with interwoven elastic webbing, completely covered and reinforced with polypropylene.

**Upholstery:** fabric or leather.

**Removable covers:** fully removable covers in fabric.

**Feet:** varnished solid wood with non-slip.

**Feature:** the combination between the elements and the accessories integrated with the model (armrest and table).

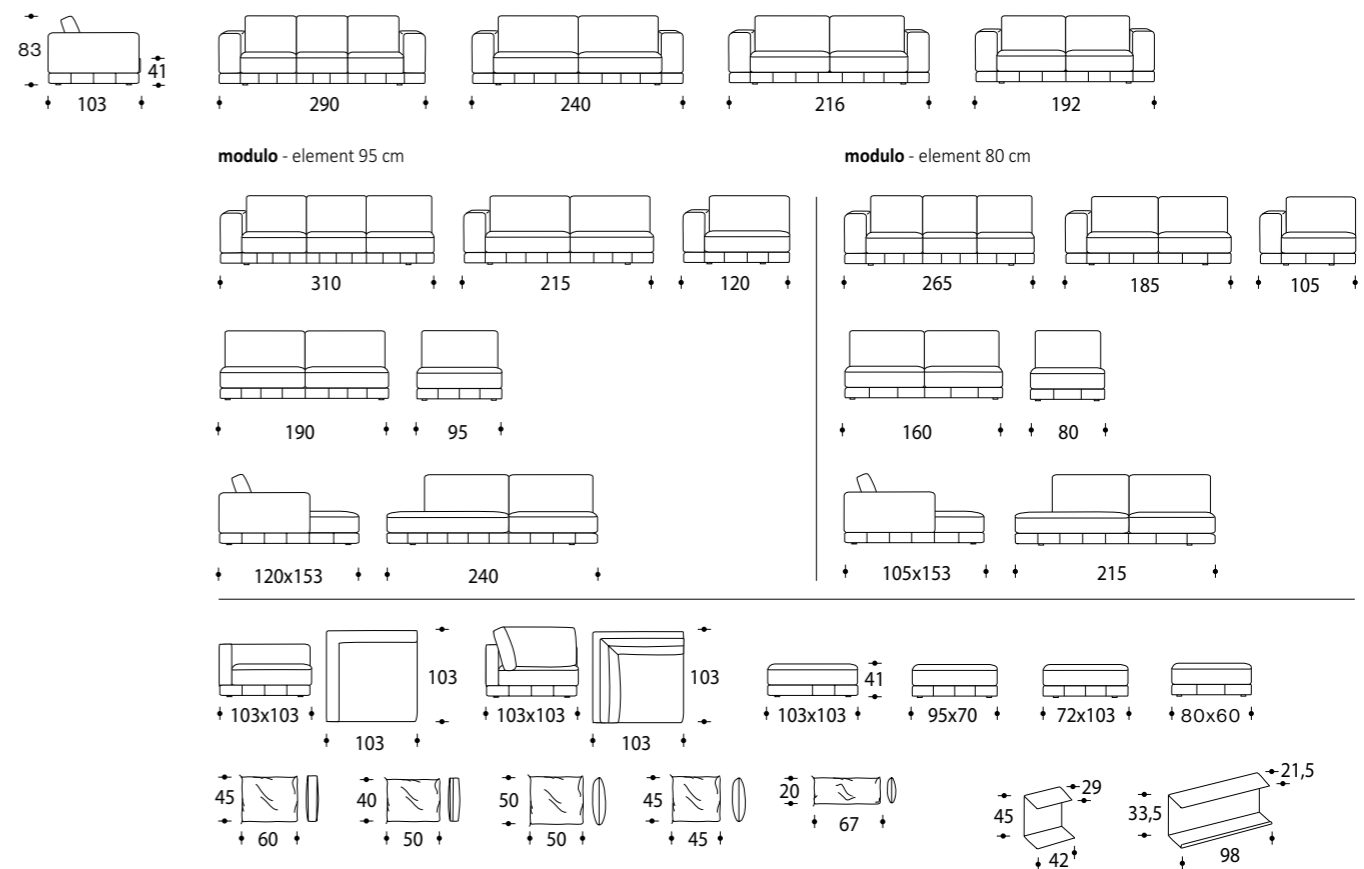



## RECITAL

È un divano di stile vintage ma contemporaneo. Forme morbide con un esclusivo piede a ponte in metallo, la sua immagine è ricercata ed elegante. La sua esclusiva sono i cuscini di schienale che mediante due leve in metallo pressofuso si alzano agevolmente creando una seduta di estremo relax. L'essenza del modello si manifesta nella cura dei dettagli sartoriali che ne accentuano il suo carattere e la sua qualità.

*It is a vintage but contemporary style sofa. Soft shapes with an exclusive metal bridge foot, its image is refined and elegant. Its exclusive is the back cushions that, with two die-cast metal levers, easily rise creating a seat of extreme relaxation. The essence of the model is manifested in the care of sartorial details that accentuate its character and quality.*













# Recital

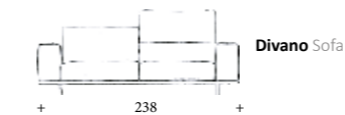
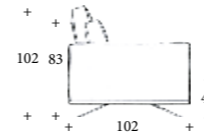

**Divano Sofa**

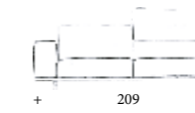

**Laterale / sx**  
One arm sofa / left

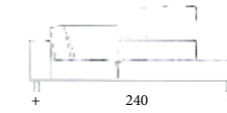

**Meridiana angolo / sx**  
Corner meridienne / left

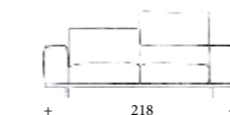

**Divano Sofa**

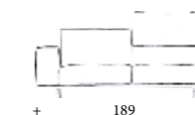

**Laterale / sx**  
One arm sofa / left

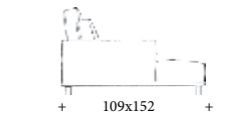

**Isola / sx**  
Longue chair / left

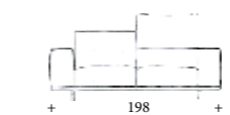

**Divano Sofa**

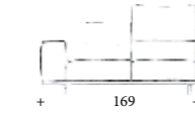

**Laterale / sx**  
One arm sofa / left

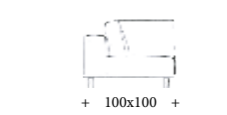

**Angolo quadro**  
Square corner

## SCHEDA TECNICA

**Imbottitura:** base ricoperta da poliuretano espanso.

**Cuscino seduta e schienale** in latex e poliuretano espanso a densità differenziata.

**Struttura:** intelaiatura in legno di varie essenze e molleggio con cinghie elastiche incrociate interamente ricoperte, con anima in

polipropilene.

**Piedi:** metallo verniciato antracite.

**Rivestimento:** tessuto e pelle. Sfoderabilità totale nella versione tessuto.

**Caratteristiche:** meccanismo manuale che permette di variare l'altezza dello schienale e la profondità di seduta.

## TECH SHEET

**Padding:** base covered with polyurethane foam.

**Back and seat cushion** in latex and different density polyurethane foam.

**Structure:** frame in different kinds of wood. Support with interwoven elastic webbing, completely covered and reinforced with polypropylene.

**Feet:** charcoal grey painted metal.

**Upholstery:** fabric or leather.

**Removable covers:** fully removable covers in fabric.

**Features:** manual mechanism allows to arrange the position of back cushions and the depth of seat.



## BLOOM

Progetto giovane, versatile e ricco di richiami di tendenza. Comode e sobrie geometrie componibili a piacere in ogni ambiente. Questo nuovo sistema ad elementi liberi fra seduta e bracciolo realizza infinite soluzioni d'arredo originali e di ottimo confort. Curato in ogni dettaglio sartoriale è la nuova frontiera del moderno, rigoroso e ricco di idee e accessori.

*Young project, versatile and full of trendy calls. Comfortable and sober geometries that can be fitted in any environment. This new system with free elements between seat and armrest creates endless original solutions and excellent comfort. Accurate in every sartorial detail is the new frontier of modern, rigorous and full of ideas and accessories.*

















## Bloom

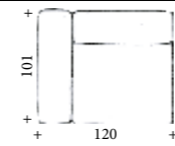
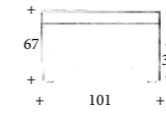

**Laterale / sx**  
One arm sofa / left

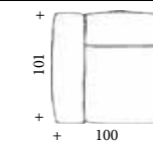

**Laterale / sx**  
One arm sofa / left

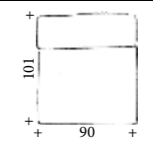

**Elemento centrale**  
Armless sofa



**Elemento centrale**  
Armless sofa

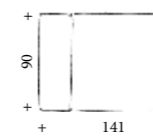

**Elemento centrale**  
Armless sofa

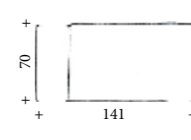

**Elemento centrale**  
Armless sofa

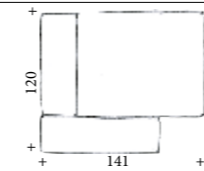

**Isola / sx**  
Longue chair / left

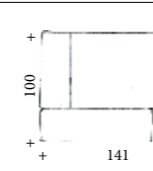

**Isola / sx**  
Longue chair / left

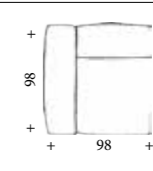

**Angolo quadro**  
Square corner

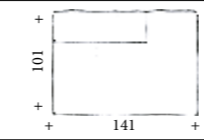

**Meridiana / dx**  
Meridienne / right

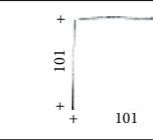

**Pouf**  
Footstool

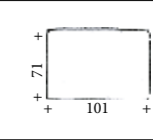

**Pouf**  
Footstool

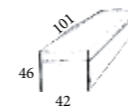

**Bracciolo basso mobile**  
Low movable armrest



**Schienale mobile**  
Movable backrest



**Cuscino Bloom**  
Bloom cushion

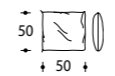

**Cuscino saponetta**  
Cushion

## SCHEDA TECNICA

**Imbottitura:** poliuretano espanso indeformabile a densità differenziate, nella seduta e nella schiena rivestito da una trapunta in mollapiuma (piuma e fibra di poliestere).  
**Struttura:** intelaiatura in legno di varie essenze e molleggio

con cinghie elastiche incrociate, interamente ricoperte e con anima in polipropilene.  
**Piedi:** legno di faggio colore nero e antiscivolo in gomma.  
**Rivestimento:** solo tessuto.  
**Sfoderabilità:** totale.

## TECH SHEET

**Padding:** different density non-deforming polyurethane foam covered with a duvet in "mollapiuma" (feather and polyester fiber) in the seat and the back.  
**Structure:** frame in different kinds of wood and support with

interwoven elastic webbing, completely covered and reinforced with polypropylene.  
**Feet:** black varnished beechwood with rubber non-slip.  
**Upholstery:** fabric only.  
**Removable covers:** fully removable covers.



## SOFTY

Originale e comodo, questo modello ha molto chiaro il tratto armonioso e formale delle sue geometriche proporzioni. Razionalità negli elementi senza rinunciare ad un avvolgente confort e al massimo della versatilità. Particolare e morbida la trapunta che lo avvolge e che lo rende testimonianza di una fusione fra un design composto e nuovo concetto di artigianalità adatta ad ogni ambiente moderno.

*Original and comfortable, this model has very clear the harmonious and formal trait of its geometric proportions. Rationality in the elements without giving up an enveloping comfort and maximum versatility. The particular and soft quilt surrounding the sofa makes it testimony of a fusion between composed design and new concept of craftsmanship suitable for any modern environment.*















# Softy

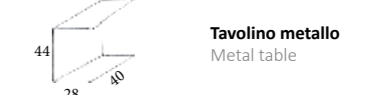
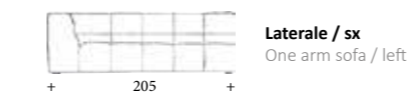
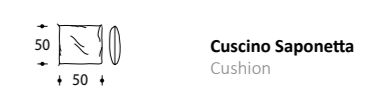
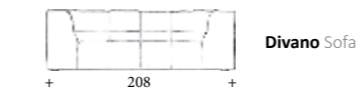
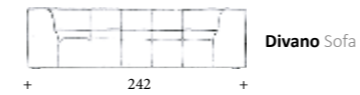
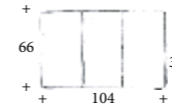

## SCHEDA TECNICA

**Imbottitura:** poliuretano espanso indeformabile a densità differenziate, con falda acrilica cucita nel rivestimento.  
**Struttura:** intelaiatura in legno di varie essenze e molleggio con cinghie elastiche incrociate, interamente

ricoperte e con anima in polipropilene.  
**Piedi:** legno di faggio verniciato colore nero con antiscivolo in gomma.  
**Rivestimento:** tessuto e pelle.  
**Sfoderabilità:** totale nella versione in tessuto e in pelle.

## TECH SHEET

**Padding:** different density non-deforming polyurethane foam with acrylic padding stitched in the upholstery.  
**Structure:** frame in different kinds of wood and support with interwoven elastic webbing, completely covered and

reinforced with polypropylene.  
**Feet:** black varnished beechwood with rubber non-slip.  
**Upholstery:** fabric and leather.  
**Removable covers:** fully removable covers in fabric and leather.



## BLOUSON

Una nuova modernità si esprime in questo divano quale risultato finale di un pensiero creativo che lo vede esclusivo in tutti i suoi elementi: piede in metallo che entra nel bracciolo, altezza e sofficità dello schienale ed un elegante rivestimento massima espressione delle lavorazioni artigianali più complesse. Questo originale modello può essere realizzato liscio o trapuntato a preferenza di stile ed esigenza.

*A new modernity is expressed in this sofa as the final result of a creative thinking that sees it exclusive in all its elements: metal foot that enters the armrest, height and softness of the backrest and an elegant upholstery as maximum expression of the most complex craftsmanship. This original model can be made smooth or quilted in preference to style and need.*

















## Blouson

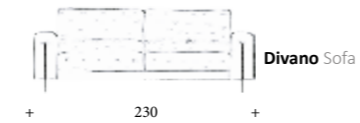
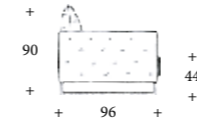

Divano Sofa

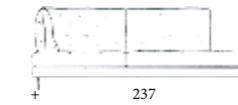
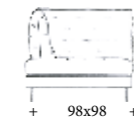
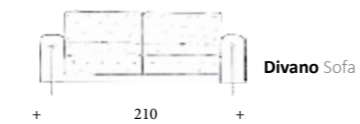
Meridiana angolo / sx  
Corner meridienne / leftAngolo quadro  
Square corner

Divano Sofa

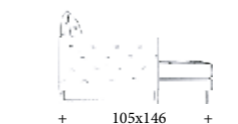
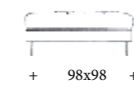
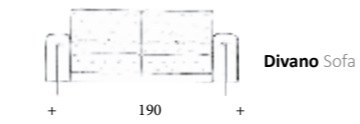
Isola / sx  
Longue chair / leftPouf  
Footstool

Divano Sofa

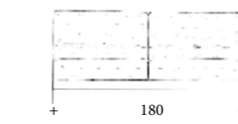
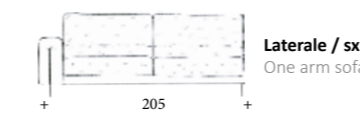
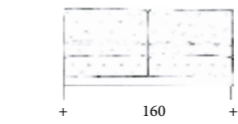
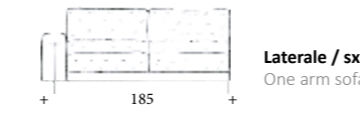
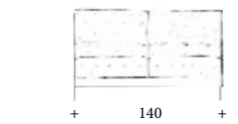
Elemento  
Armless sofaLaterale / sx  
One arm sofa / leftElemento  
Armless sofaLaterale / sx  
One arm sofa / leftElemento  
Armless sofa

## SCHEDA TECNICA

**Imbottitura:** scocca rivestita di poliuretano espanso a densità differenziata. Rivestimento trapuntato con falda acrilica.  
**Struttura:** legno di varie essenze e metallo.  
Molleggio con cinghie

elastiche incrociate, interamente ricoperte, con anima in polipropilene.  
**Piedi:** metallo verniciato antracite.  
**Rivestimento:** tessuto e pelle. Interamente sfoderabile nelle versioni tessuto e pelle.

## TECH SHEET

**Padding:** body in different density polyurethane foam, coated with acrylic padding.  
**Structure:** frame in different kinds of wood and metal.  
Support with interwoven elastic webbing, completely

covered and reinforced with polypropylene.  
**Feet:** Charcoal grey painted metal.  
**Upholstery:** fabric or leather.  
**Removable covers:** fully removable covers in fabric and leather.



## PLUMY

Questo modello è attento alle nuove esigenze: altezza di schienale e minima profondità di seduta.

Propone eleganza, comodità e tecnologia dando grande valore allo spazio.

Questo divano si distingue per l'armonia delle sue proporzioni e la leggerezza dei suoi volumi, non ultima l'eleganza del particolare piedino in metallo scuro. Nuove linee di eclettica versatilità.

*This model is attentive to new requirements: height for backrests and minimum depth on seat.*

*It offers elegance, comfort and technology giving great value to the environment.*

*This sofa stands out for the harmony of its proportions and the lightness of its volumes, not least the elegance of the particular dark metal foot. New lines of eclectic versatility.*

















# Plumy

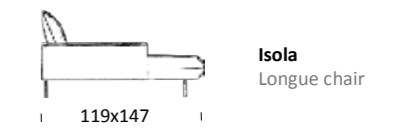
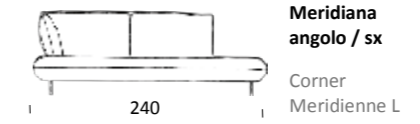
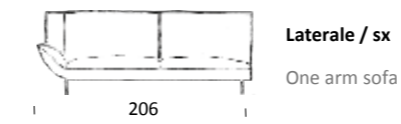
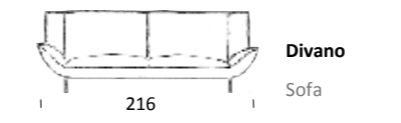
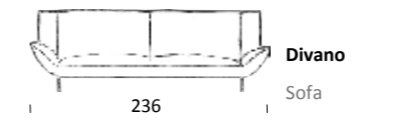
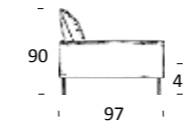

## SCHEDA TECNICA

**Imbottitura:** scocca rivestita di poliuretano espanso indeformabile a densità differenziata rivestito di falda acrilica. Schienali in poliuretano espanso rivestiti con trapunta in Latex.  
**Struttura:** legno di varie essenze nella base. Schienali in metallo.

Molleggio in cinghie elastiche incrociate, interamente ricoperte, con anima in polipropilene.  
Molle a spirale in metallo negli schienali.  
**Piedi:** metallo cromato scuro.  
**Rivestimento:** tessuto e pelle. Interamente sfoderabile nella versione tessuto.

## TECH SHEET

**Padding:** body in different density non-deforming polyurethane foam coated with acrylic padding. Back cushions in polyurethane foam coated with latex quilt.  
**Structure:** frame in different kinds of wood. Metal back cushions. Support with interwoven elastic webbing,

completely covered and reinforced with polypropylene. Coil metal springs on back cushions.  
**Feet:** dark chromium-plated steel.  
**Upholstery:** fabric or leather.  
**Removable covers:** fully removable covers in fabric.



## REVERSO

Divano dal design ricercato e ricco di contaminazioni di tendenza. Originali geometrie fra loro sovrapposte, attuali e vintage, sono rivelate dalla modernità degli esclusivi cuscini di schiena con meccanismo relax. Questo nuovo sistema di seduta, con schienali posizionabili a piacere lungo la struttura, declina soluzioni originali e di ottimo comfort. "Reverso" è protagonista di stile e comodità in un'armonia fra estetica e tecnologia.

*A sofa with a sophisticated design, infected with the latest trends. Original overlapping geometries, current and vintage, are revealed by the modernity of exclusive backrest cushions with relax mechanism. This new seating system, with backrests that can be positioned at will along the structure, offers original solutions and excellent comfort. "Reverso" is the protagonist of style and comfort in a balance between aesthetics and technology.*

















## SCHEDA TECNICA

**Imbottitura:** scocca rivestita da poliuretano espanso indeformabile a densità differenziata ricoperto da falda acrilica. Cuscino schienale in poliuretano espanso e latex. Fodera 100% cotone.

**Struttura:** intelaiatura in legno di varie essenze e molleggio con cinghie elastiche incrociate, interamente ricoperte e con anima in polipropilene.

**Rivestimento:** tessuto o pelle.

**Sfoderabilità:** totale nella versione in tessuto, solo cuscino schienale per la versione in pelle.

**Piedi:** metallo cromato scuro.

**Caratteristiche:** è possibile personalizzare il proprio comfort variando l'altezza dello schienale attraverso un meccanismo manuale. Gli schienali sono liberamente posizionabili lungo tutta la struttura di schiena.

## TECH SHEET

**Padding:** body covered with polyurethane foam coated with acrylic padding. Back cushions in polyurethane foam and latex. Lining 100% cotton.

**Structure:** frame in different kinds of wood and support with interwoven elastic webbing, completely covered and reinforced with polypropylene.

**Upholstery:** fabric or leather.

**Removable covers:** fully removable covers in fabric, back cushion only if leather.

**Feet:** dark chromium-plated steel.

**Features:** you can customize your comfort changing the height of the back cushion through a manual mechanism. You can arrange the position of the back cushions as you prefer all along the back structure.

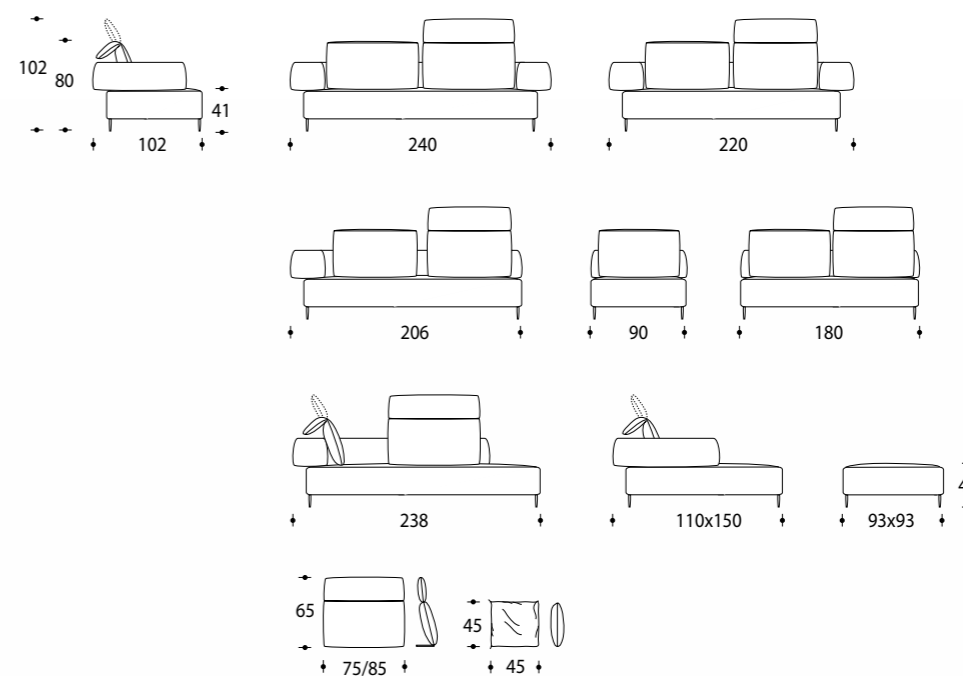

• REVERSO (divano componibile/modular sofa system) – L/W316 × P/D150 × H80/102 cm –

tessuto/fabric: Cat.Super Extra Polo col.02



## OCEAN

È il progetto contemporaneo d'immagine ricercata ed elegante. Questo divano è la risposta concreta al desiderio di personalizzare il proprio comfort nella profondità di seduta e nell'altezza dello schienale. L'essenza del modello è il raggiungimento di una posizione relax ineguagliabile, mantenendo linee pulite ed essenziali.

*A contemporary piece designed for elegance and allure. This sofa is the physical representation of how you would imagine personalised comfort, with its high back and deep seat. Its appeal is the unparalleled comfort it offers whilst displaying clean, uncluttered lines.*





















**SCHEDA TECNICA**

**Imbottitura:** scocca rivestita da poliuretano espanso. Bracciolo in poliuretano espanso indeformabile a densità differenziata ricoperto da falda acrilica. Cuscino di seduta in poliuretano espanso indeformabile a densità differenziata ricoperto da foderina in latex canalizzata. Fodera 100% cotone. Cuscino schienale in latex canalizzata con inserto in poliuretano espanso indeformabile. Fodera 100% cotone.

**Struttura:** intelaiatura in legno di varie essenze e metallo. Molleggio con cinghie elastiche incrociate, interamente ricoperte e con anima in polipropilene.

**Rivestimento:** tessuto e/o pelle.

**Sfoderabilità:** totale nella versione in tessuto.

**Piedi:** metallo cromato scuro.

**Caratteristica:** è possibile personalizzare il proprio comfort attraverso un meccanismo manuale che permette di variare l'altezza dello schienale la profondità di seduta.

**TECH SHEET**

**Padding:** body in polyurethane foam. Armrest in different density non-deforming polyurethane foam coated with acrylic cover.

**Seat cushion** in different density non-deforming polyurethane foam coated with channeled latex duvet. Lining 100% cotton. Back cushion in channeled latex and different density non-deforming polyurethane foam core. Lining 100% cotton.

**Structure:** frame in different kinds of wood and steel. Support with interwoven elastic webbing, completely covered and reinforced with polypropylene.

**Upholstery:** fabric or leather.

**Removable covers:** fully removable covers in fabric.

**Feet:** dark chromium-plated steel.

**Feature:** you can customize your comfort through a manual mechanism which allows to vary the height of the back cushion and the seat depth.

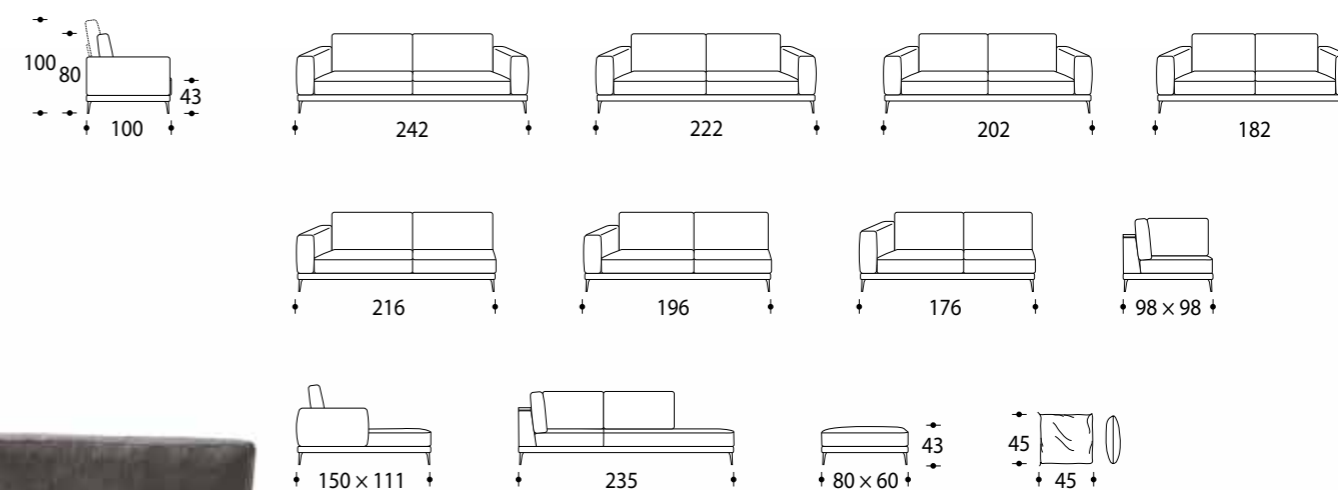



## ALGARVE

Una nuova formula che abbina estetica e tecnologia in grado di rendere questo modello protagonista di stile.

Comodità e qualità si fondono fra loro. Le differenti posizioni del meccanismo manuale sullo schienale consentono un comfort personalizzato, senza alterare il linguaggio internazionale e l'eleganza indiscussa. È questo il risultato finale di un processo creativo di una firma del design italiano.

*A new formula combining technology with stylish good looks, raising this model to the status of trend setter. Comfort and quality fuse each other together. The range of backrest positions with manual mechanism offer unrivalled personalised comfort with international appeal and undisputed elegance. The finished product of a design process from an Italian design specialist.*

























## SCHEDA TECNICA

**Imbottitura:** schienale, seduta e bracciolo in poliuretano espanso indeformabile a densità differenziata ricoperto da foderina in piuma canalizzata. Fodera 100% cotone.  
**Struttura:** intelaiatura in legno di varie essenze e molleggio con cinghie elastiche incrociate, interamente ricoperte e con anima in polipropilene.  
**Rivestimento:** tessuto e/o pelle.  
**Sfoderabilità:** totale nella versione in tessuto.

**Piedi:** metallo cromato scuro.  
**Caratteristica:** è possibile personalizzare il proprio comfort attraverso un meccanismo manuale che permette di variare l'altezza dello schienale.

## TECH SHEET

**Padding:** back cushion, seat cushion and armrest in different density non-deforming polyurethane foam coated with channeled down duvet. Lining 100% cotton.

**Structure:** frame in different kinds of wood and support with interwoven elastic webbing, completely covered and reinforced with polypropylene.

**Upholstery:** fabric or leather.

**Removable covers:** fully removable covers in fabric.

**Feet:** dark chromium-plated steel.

**Feature:** you can customize your comfort through a manual mechanism which allows to vary the height of the back cushion.

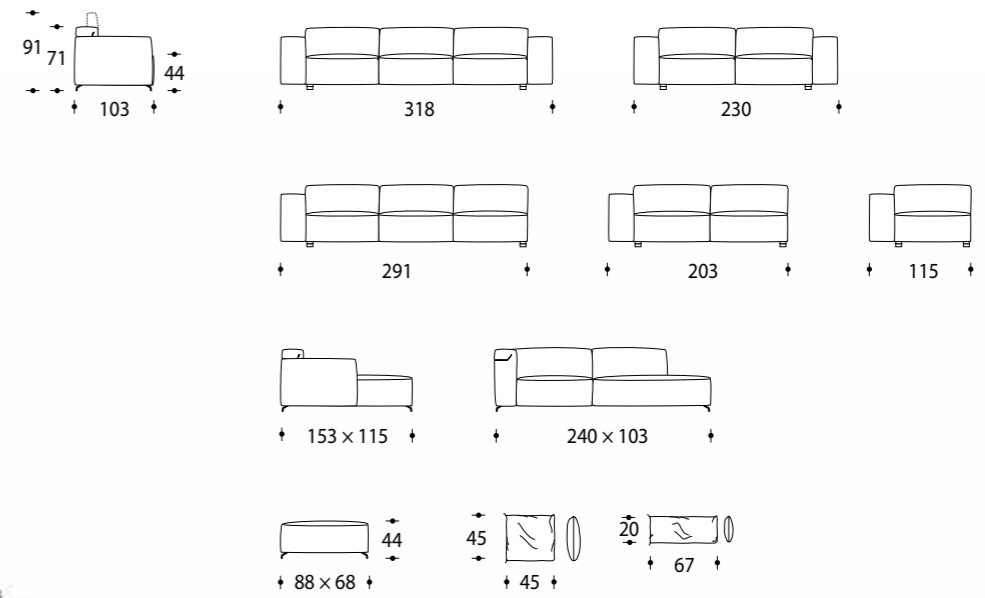



## OPIUM

Un progetto di stile.

Questo modello unisce la leggerezza dei volumi a un'estrema comodità. Una pura geometria è descritta dal particolare piedino incastonato nella struttura.

Un nuovo linguaggio del design contemporaneo in cui rigore del disegno e morbidezza della seduta si integrano alla perfezione. "Opium", con la sua essenziale eleganza senza tempo, diventa un protagonista di grande attualità.

*A design with style.*

*This model combines the lightness of its volumes with extreme comfort. The unusual foot embedded in the structure conveys pure geometry. Within this new language of contemporary design, the rigour of the outline and softness of the seat are integrated to perfection. With its timeless elegance, "Opium" becomes a prominent representation of the present day.*













## SCHEDA TECNICA

**Imbottitura:** base ricoperta da poliuretano espanso. Scocca in poliuretano espanso indeformabile a densità differenziata ricoperta da falda acrilica. Cuscino di seduta in poliuretano espanso indeformabile a densità differenziata ricoperto da foderina in piuma canalizzata. Fodera 100% cotone. Cuscino di schiena in mollapiuma canalizzata (miscela bilanciata di piuma e ovatta acrilica, per assicurare la massima morbidezza). Fodera 100% cotone.

**Struttura:** intelaiatura in metallo e legno di varie essenze. Molleggio con cinghie elastiche incrociate, interamente ricoperte e con anima in polipropilene.

**Rivestimento:** tessuto e/o pelle.

**Sfoderabilità:** totale nella versione in tessuto.

**Piedi:** metallo cromato scuro.

**Caratteristica:** dettaglio del piedino integrato alla base. Opzione bracciolo corto o lungo.

## TECH SHEET

**Padding:** base covered with polyurethane foam. Structure in different density non-deforming polyurethane foam coated with acrylic padding. Seat cushion in different density non-deforming polyurethane foam coated with channeled down duvet. Lining 100% cotton. Back cushion in "mollapiuma" (a balanced mixture of feathers and acrylic batting to ensure maximum softness). Lining 100% cotton.

**Structure:** frame in steel and different kinds of wood. Support with interwoven elastic webbing, completely covered and reinforced with polypropylene.

**Upholstery:** fabric or leather.

**Removable covers:** fully removable covers in fabric.

**Feet:** dark chromium-plated steel.

**Feature:** the detail of the foot nestled in the base. Short or long armrest as option.

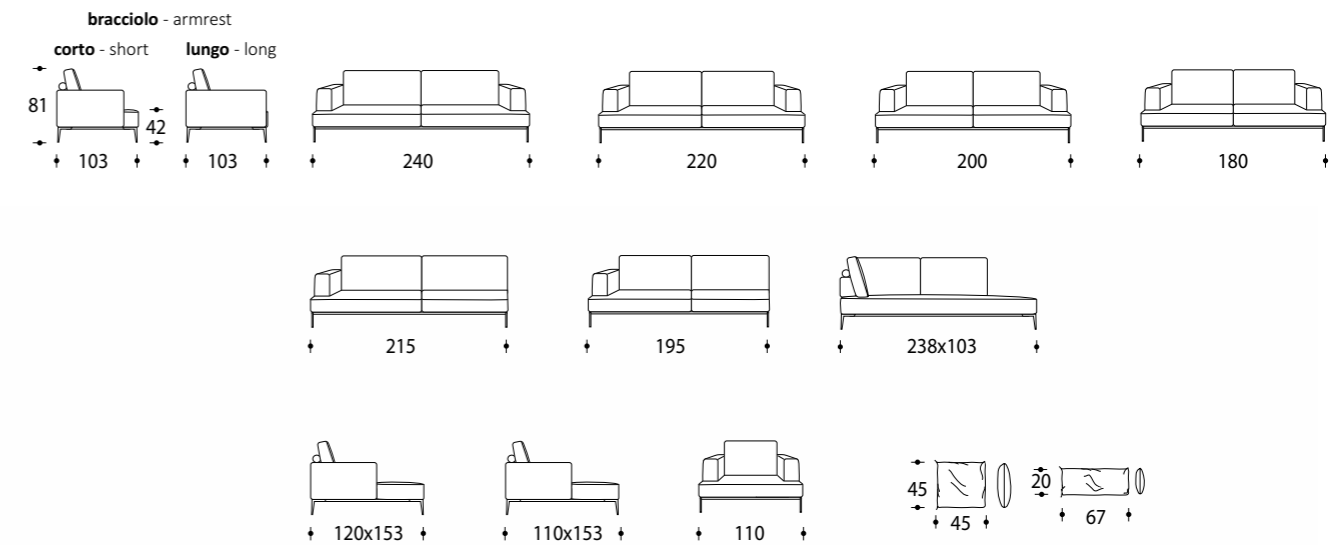



## LUNGARNO

Un background lontano per un appeal senza tempo e un design contemporaneo sono la forza espressiva di questo modello. Alto da terra e contenuto nella profondità riflette un design raffinato e rigoroso. La cucitura che disegna braccioli e cuscini, rafforza il carattere dettato dall'incontro sapiente di volumi squadrati dalle diverse fogge, che offre molteplici ed innovative combinazioni.

*A background away for a timeless appeal and a contemporary design are the expressive power of this model. High off the ground and in depth content reflects a refined design and rigorous. The stitching that draws armrests and pillows, strengthens the character dictated by the meeting of wise square volumes from different styles, offering multiple and innovative combinations.*





















**SCHEDATECNICA**

**Imbottitura:** scocca rivestita da poliuretano espanso. Bracciolo in poliuretano espanso indeformabile a densità differenziata ricoperto da foderina in latex canalizzata. Cuscino di seduta in poliuretano espanso indeformabile a densità differenziata ricoperto da foderina in latex canalizzata. Fodera 100% cotone. Cuscino schienale 100% in latex canalizzata. Fodera 100% cotone.

**Struttura:** intelaiatura in legno di varie essenze e molleggio con cinghie elastiche incrociate, interamente ricoperte e con anima in polipropilene.

**Rivestimento:** tessuto e/o pelle.

**Sfoderabilità:** totale nella versione in tessuto.

**Piedi:** metallo cromato scuro.

**Caratteristiche:** può essere richiesto un rivestimento composito pelle (scocca) e tessuto (cuscinate). Opzione bracciolo corto o lungo.

**TECH SHEET**

**Padding:** body covered with polyurethane foam. Armrest in different density non-deforming polyurethane foam coated with channeled latex. Seat cushion in channeled latex over different density non-deforming polyurethane foam. Lining 100% cotton. Back cushions in 100% channeled latex. Lining 100% cotton.

**Structure:** frame in different kinds of wood and support with interwoven elastic webbing, completely covered and reinforced with polypropylene.

**Upholstery:** fabric and/or leather.

**Removable covers:** fully removable covers in fabric.

**Feet:** dark chromium-plated steel.

**Features:** composite upholstery fabric (cushions) and leather (body) available. Short or long armrest as option.

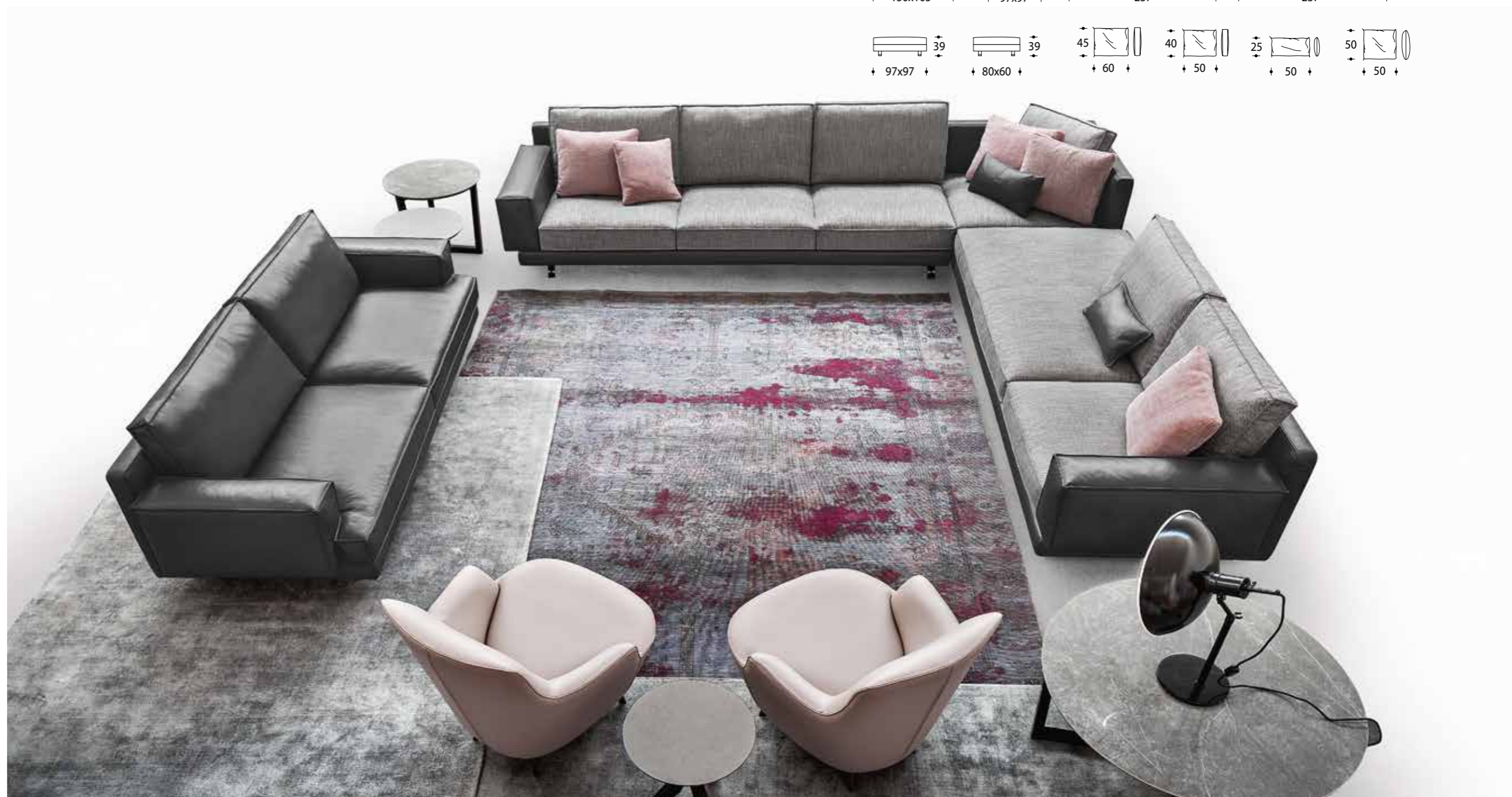
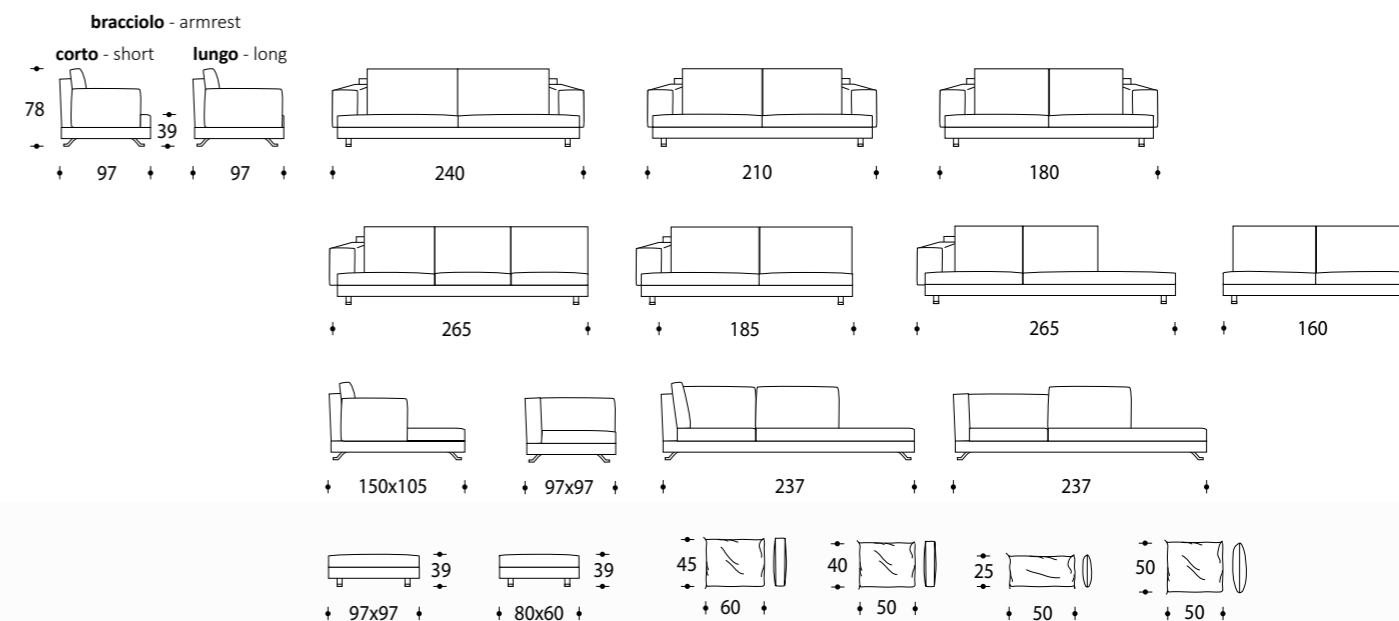



## DOWNTOWN

Un progetto moderno di nuova generazione ottenuto dalla ricerca di un equilibrio formale tra la morbidezza dei cuscini e la leggerezza della struttura rialzata da terra. Grazie al design degli schienali e dei braccioli che poggiano su una base molto sottile, le dimensioni del modello risultano contenute in profondità. Il piedino cromato scuro, raffinato ed elegante, rende aereo il modello valorizzandone la forma moderna ed essenziale. Il dettaglio che caratterizza il lato è un tocco di classe che ammorbidisce il suo minimalismo.

*A modern, new generation project, achieved from the desire for a formal balance between the softness of the cushions and the lightness of the furniture. Thanks to the design of the backs and armrests on a very slender base, the sizes of our models are restrained. The dark, refined and elegant footrest gives the model an aerial quality, emphasising its contemporary and essential form. The details that characterise the side add a touch of class that softens its minimalist appearance.*





















**SCHEDA TECNICA**

**Imbottitura:** base rivestita da poliuretano espanso. Scocca in poliuretano espanso indeformabile a densità differenziata ricoperto da falda acrilica. Cuscino di seduta in poliuretano espanso indeformabile a densità differenziata ricoperto da foderina in latex canalizzata. Fodera 100% cotone. Cuscino schienale 100% in latex canalizzata. Fodera 100% cotone.

**Struttura:** intelaiatura in legno di varie essenze e tubolare metallico di rinforzo. Molleggio con cinghie elastiche incrociate, interamente ricoperte e con anima in polipropilene.

**Rivestimento:** tessuto o pelle.

**Sfoderabilità:** totale nella versione in tessuto.

**Piedi:** metallo cromato scuro.

**Caratteristica:** mensola bracciolo come opzione in tutte le versioni.

**TECH SHEET**

**Padding:** base covered with polyurethane foam . Body in different density non-deforming polyurethane foam coated with acrylic layer.

Seat cushion in channeled latex duvet over different density non-deforming polyurethane foam. Lining 100% cotton. Back cushion in 100% channeled latex. Lining 100% cotton.

**Structure:** frame in different kinds of wood and steel tubular reinforcement. Support with interwoven elastic webbing, completely covered and reinforced with polypropylene.

**Upholstery:** fabric or leather.

**Removable covers:** fully removable covers in fabric.

**Feet:** dark chromium-plated steel.

**Feature:** optional side shelf available for all variations.

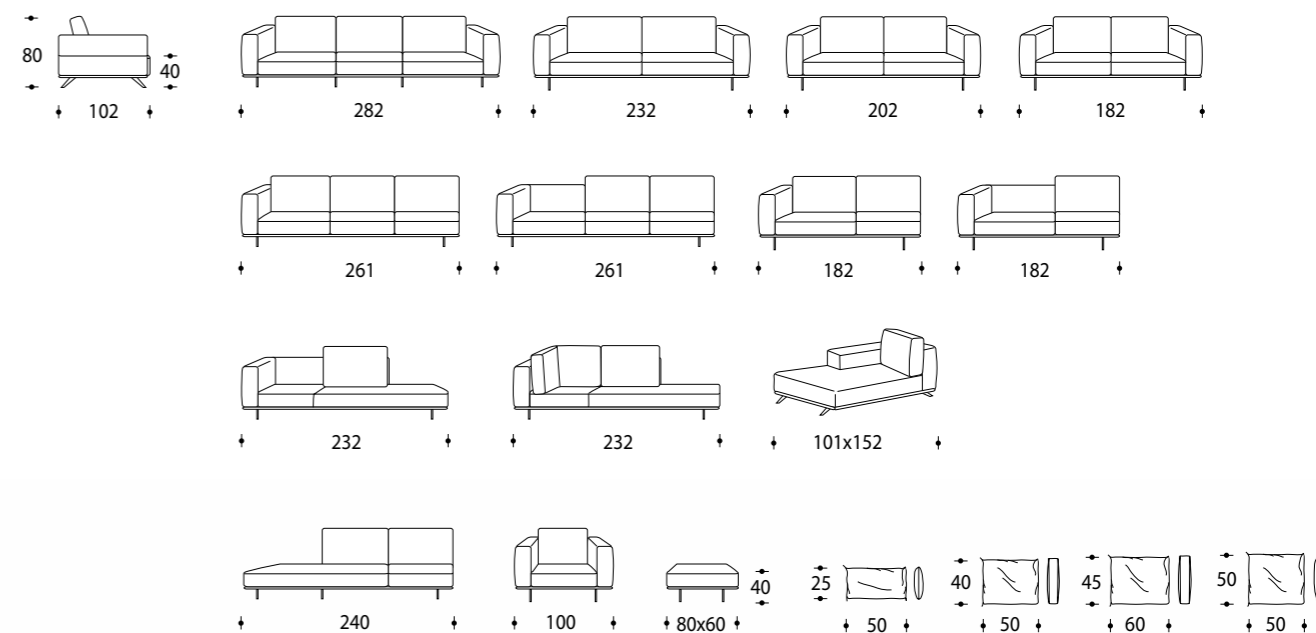



## RITMO

"Ritmo" arreda lo spazio con grande carattere. Un modello creato per personalizzare il comfort, in tutti i suoi elementi, con gli esclusivi movimenti relax. Ogni seduta può trasformarsi in chaiselongue ed il bracciolo può avere diverse posizioni. "Ritmo" è un progetto dalle linee contemporanee ed eleganti, unico nella sua componibilità e cura di ogni dettaglio costruttivo.

*"Ritmo" furnishes space with great character. A model created for customised comfort, in all its elements, with exclusive relaxation movements. Each seat can be transformed into a chaiselongue and the armrest can be moved to different positions. "Ritmo" is a project with contemporary and elegant lines, unique in its modularity and attention to every construction detail.*

















**SCHEDATECNICA**

**Imbottitura:** base ricoperta da poliuretano espanso. Cuscino di seduta, bracciolo e appoggiareni in poliuretano espanso a densità differenziata ricoperto da falda acrilica. Cuscino schienale in poliuretano espanso e trapunta in latex. Fodera 100% cotone.

**Struttura:** intelaiatura in legno di varie essenze e molleggio con cinghie elastiche incrociate, interamente ricoperte e con anima in polipropilene.

**Rivestimento:** tessuto o pelle.

**Sfoderabilità:** totale nella versione in tessuto. Solo per cuscino di seduta e schienale nella versione in pelle.

**Piedi:** metallo cromato scuro.

**Caratteristica:** meccanismo manuale relax sullo schienale che permette di scegliere il proprio comfort tra due profondità di seduta.

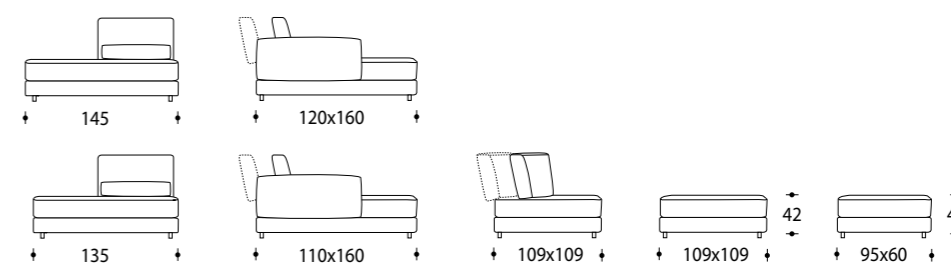
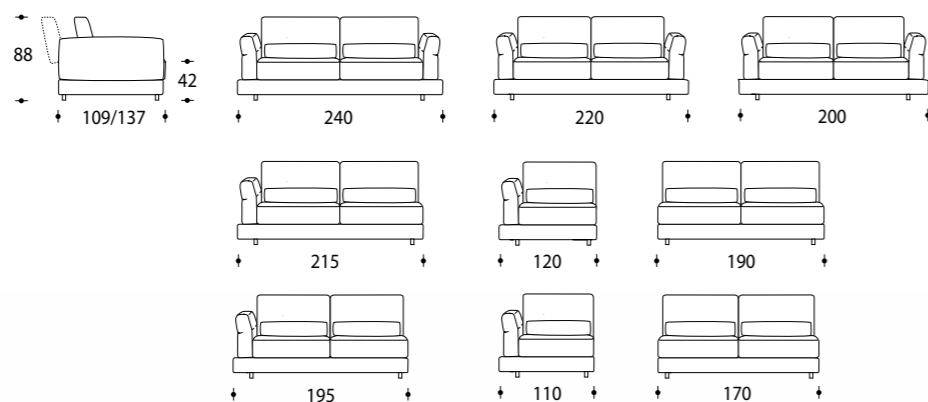

**TECH SHEET**

**Padding:** base covered with polyurethane foam. Seat cushion, armrest and kidney cushion in different density polyurethane foam coated with acrylic padding. Back cushion in polyurethane foam coated with latex quilt. Lining 100% cotton.

**Structure:** frame in different kinds of wood and support with interwoven elastic webbing, completely covered and reinforced with polypropylene.

**Upholstery:** fabric or leather.

**Removable covers:** fully removable covers in fabric, back and seat cushions only in leather.

**Feet:** dark chromium-plated steel.

**Feature:** manual mechanism on the back that lets you choose your own comfort between two seat depths.





## METROPOL

Dalle linee moderne e grintose, essenziale ed unico nelle cuciture che lo disegnano, le sue linee avvolgenti e morbide propongono un'estetica di grande originalità, donando a questo modello uno stile casual e chic. Casual per il suo comfort informale in piuma, chic per l'originalità e raffinatezza del disegno.

*From decisive modern lines, essential and unique in their stitching. Its soft, enveloping lines propose great originality and aesthetics presenting this model with casual and chic style. Casual in its informal feather comfort and chic in its refined, original design.*

















**SCHEDATECNICA**

**Imbottitura:** scocca in poliuretano espanso ricoperto da falda acrilica. Cuscino di seduta in poliuretano espanso indeformabile a densità differenziata ricoperto da foderina in piuma canalizzata. Fodera 100% cotone.

Cuscino di schiena in mollapiuma (miscela bilanciata di piuma e ovatta acrilica, per assicurare la massima morbidezza) con anima in poliuretano espanso indeformabile a densità differenziata. Fodera 100% cotone.

**Struttura:** intelaiatura in legno di varie essenze e molleggio con cinghie elastiche incrociate, interamente ricoperte e con anima in polipropilene.

**Rivestimento:** tessuto o pelle.

**Sfoderabilità:** totale nella versione in tessuto e in pelle.

**Piedi:** legno massello verniciato.

**Caratteristica:** la cucitura che ne disegna il profilo.

**TECH SHEET**

**Padding:** structure in polyurethane foam coated with acrylic padding. Seat cushion in 100% channeled down duvet over different density non-deforming polyurethane foam. Lining 100% cotton. Back cushion in mollapiuma (a balanced mixture of small feathers new and acrylic batting to ensure maximum softness) over different density non-deforming polyurethane foam. Lining 100% cotton.

**Structure:** frame in different kinds of wood and support with interwoven elastic webbing, completely covered and reinforced with polypropylene.

**Upholstery:** fabric or leather.

**Removable covers:** fully removable covers both in fabric and in leather.

**Feet:** varnished solid wood.

**Feature:** the stitching which draws the contour.

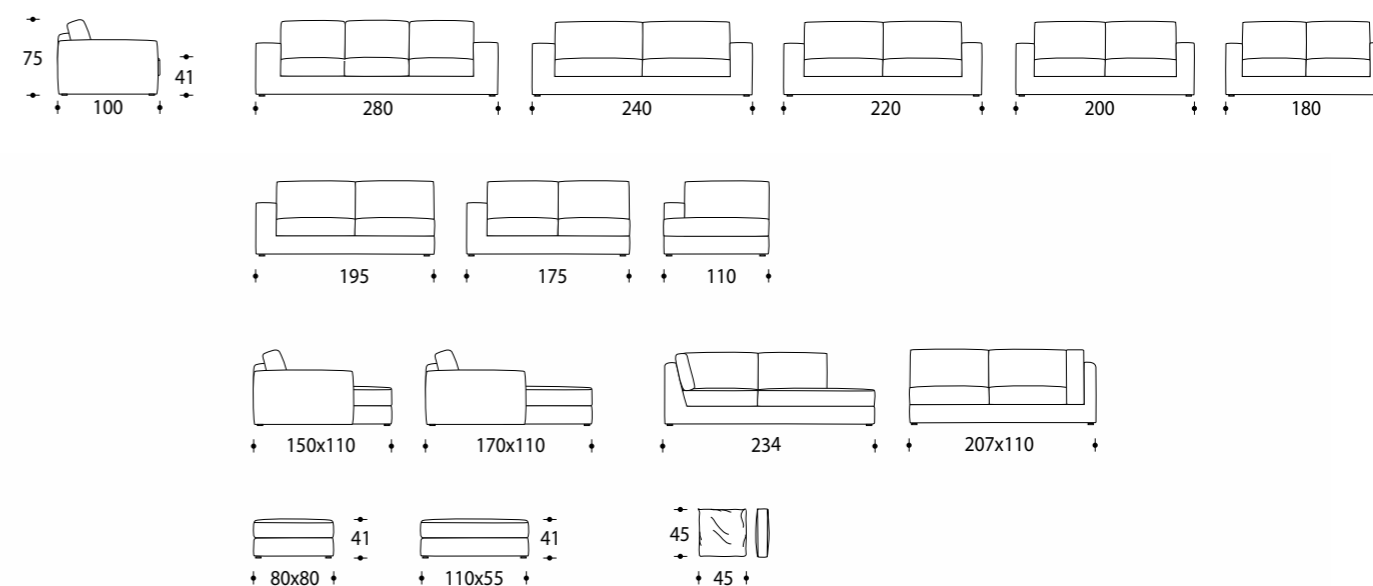



## OPEN SPACE

Un progetto che nasce da un pensiero razionale. Una risposta contemporanea per personalizzare il proprio comfort grazie al movimento relax negli schienali, che permette una doppia profondità di seduta. L'essenza del modello si manifesta nella cura dei dettagli costruttivi che ne accentuano il carattere deciso. Un sistema versatile dalle linee pulite ed essenziali e al contempo, molto originali.

*A project that rises from rational thought. A contemporary response to personalize individual comfort thanks to the relaxing movement of the back rest that permits profound seating pleasure. The essence of this model displays much in the constructive detail to which its decisive character accents. A versatile system of clean lines and essentials and simultaneously very original.*













**SCHEDATECNICA**

**Imbottitura:** base ricoperta da poliuretano espanso. Bracciolo, cuscino di schiena e seduta in poliuretano espanso indeformabile a densità differenziata ricoperto da foderina in piuma canalizzata. Fodera 100% cotone su cuscinature e bracciolo.

**Struttura:** intelaiatura in legno di varie essenze e metallo sullo schienale. Molleggio con cinghie elastiche incrociate, interamente ricoperte e con anima in polipropilene.

**Rivestimento:** tessuto o pelle.

**Sfoderabilità:** totale nella versione tessuto.

**Piedi:** legno massello verniciato.

**Caratteristiche:** cucitura speciale a "X" in filo grigio (a richiesta tono su tono). Meccanismo manuale relax sullo schienale che permette di scegliere il proprio confort tra due profondità di seduta.

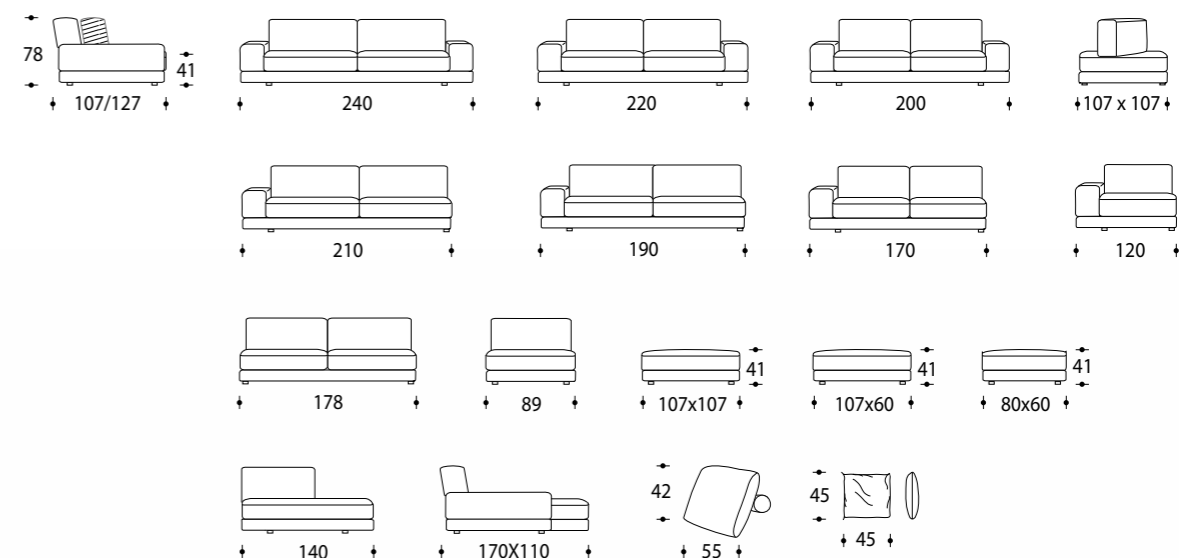

**TECH SHEET**

**Padding:** base covered with polyurethane foam. Armrest, seat and back cushion in different density non-deforming polyurethane foam coated with channeled down duvet. Lining 100% cotton for cushions and armrest.

**Structure:** frame in different kinds of wood and steel on back cushion. Support with interwoven elastic webbing, completely covered and reinforced with polypropylene.

**Upholstery:** fabric or leather.

**Removable covers:** fully removable covers in fabric.

**Feet:** varnished solid wood.

**Features:** particular "X" stitching with grey thread (matching thread on request). Manual relax mechanism on the back that lets you choose your own comfort between two seat depths.





## SWING

L'immagine sofisticata ed elegante è esaltata dall'equilibrio fra la leggerezza dei volumi e il dettaglio stilistico della struttura. Lo schienale relax permette due diverse profondità di seduta. Un abbinamento armonioso fra estetica e tecnologia in grado di rendere questo modello protagonista di stile nella casa.

*The sophisticated and elegant image is exulted in the equilibrium between lightness of volume and the stylistic detail of the structure. The relaxing back rest allows for two different framework seating depths. An harmonious link between aesthetics and technology, able to make this model the protagonist of style in any home.*













**SCHEDATECNICA**

**Imbottitura:** base ricoperta da poliuretano espanso. Bracciolo e schiena fissa in poliuretano espanso ricoperto da falda acrilica. Cuscino di seduta in piuma canalizzata con inserto in poliuretano espanso indeformabile a densità differenziata. Fodera 100% cotone.

Cuscino mobile di schiena 100% in piuma canalizzata. Fodera 100% cotone.

**Struttura:** intelaiatura in legno di varie essenze e molleggio con cinghie elastiche incrociate, interamente ricoperte e con anima in polipropilene.

**Rivestimento:** tessuto o pelle.

**Sfoderabilità:** totale nella versione in tessuto.

**Piedi:** metallo cromato chiaro o scuro.

**Caratteristica:** meccanismo relax manuale sullo schienale che permette di scegliere il proprio comfort tra due profondità di seduta e due altezze di schienale.

**TECH SHEET**

**Padding:** base covered with polyurethane foam. Armrest and backrest in polyurethane foam coated with acrylic padding. Seat cushion in channeled down and different density non-deforming polyurethane foam core. Lining 100% cotton. Movable back cushions 100% channeled down. Lining 100% cotton.

**Structure:** frame in different kinds of wood and support with interwoven elastic webbing, completely covered and reinforced with polypropylene.

**Upholstery:** fabric or leather.

**Removable covers:** fully removable covers in fabric.

**Feet:** light or dark chromium-plated steel.

**Feature:** relax manual mechanism on the back which lets you choose your own comfort between two seat depths and two back heights.

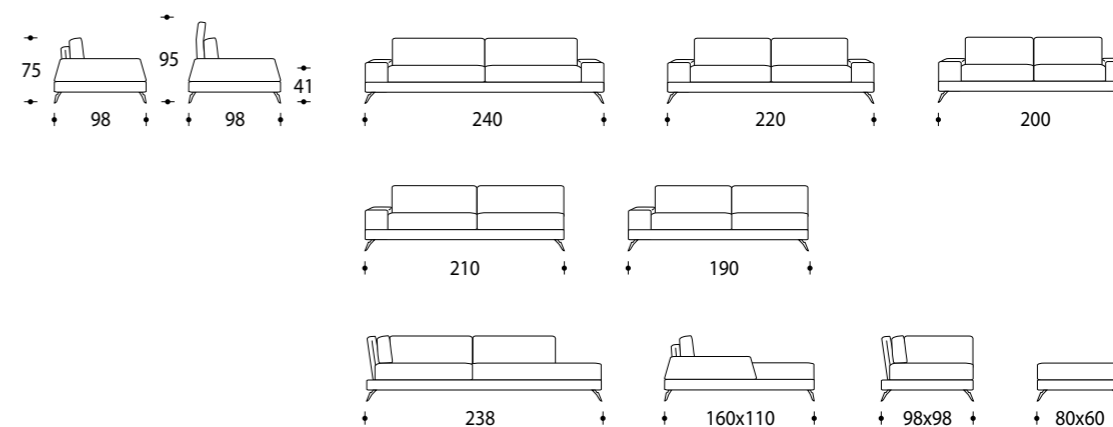



## ASTRO

Dove il valore di un progetto diventa qualità e vera comodità.

Questo modello sobrio ma sofisticato, diviene elegante e moderno con la combinazione dei suoi cuscini volanti.

Una nuova tecnologia con staffe in fibra di vetro conferisce un nuovo confort allo schienale a sbalzo, rendendolo elastico.

Ogni scelta è il risultato di un intelligente processo che ne fanno un complemento di design inseribile in ogni ambiente.

*Where the value of a project becomes quality and true comfort.*

*This sober but sophisticated model becomes elegant and modern with the combination of its loose cushions.*

*A new technology with fiberglass brackets gives new comfort to the offset backrest, making it elastic.*

*Each choice is the result of an intelligent process that makes it a design complement that can be inserted in any environment.*

### SCHEDA TECNICA

Imbottitura: seduta e schienale rivestiti da poliuretano espanso indeformabile a alta densità differenziata.

Struttura: seduta in legno di varie essenze, schienale in metallo.

Molleggio con cinghie elastiche incrociate, interamente ricoperte, con anima in polipropilene.

Piedi: metallo verniciato antracite.

Rivestimento: pelle.

Caratteristiche: meccanismo girevole con ritorno alla posizione iniziale.T

### TECH SHEET

Padding: seat and back in high different density non-deforming polyurethane foam.

Structure: seat in different kinds of wood, metal back. Support with interwoven elastic webbing, completely covered and reinforced with polypropylene.

Feet: anthracite varnished metal.

Upholstery: leather.

Feature: pivoting base with automatic return function to initial position

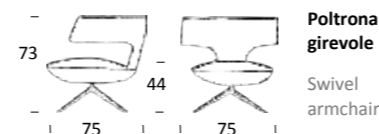

**Poltrona girevole**

Swivel armchair





Poltroncina creata per ogni spazio, ricercata, moderna, è un nuovo oggetto di design. Originale il contrasto della sua forma classica con la modernità del suo piede ruotante o dei piedini fissi in metallo. Oggetto ricercato ed attuale quale complemento di ogni stile contemporaneo.

## SHISHA

*Armchair created for every space, refined, modern, is a new design object. Original the contrast of its classic shape with the modernity of its rotating foot or fixed metal feet. A refined and current object as a complement to any contemporary style.*

### SCHEDA TECNICA

**Imbottitura:** scocca rivestita di poliuretano espanso indeformabile a densità differenziata.

**Struttura:** legno di varie essenze. Molleggio con cinghie elastiche incrociate, interamente ricoperte, con anima in polipropilene.

**Piedi:** metallo verniciato antracite.

**Rivestimento:** tessuto e pelle. Non sfoderabile.

**Caratteristiche:** nella versione girevole meccanismo con ritorno alla posizione iniziale.

### TECH SHEET

**Padding:** body in different density non-deforming polyurethane foam.

**Structure:** frame in different kinds of wood. Support with interwoven elastic webbing, completely covered and reinforced with polypropylene.

**Feet:** charcoal grey painted metal.

**Upholstery:** fabric or leather, not removable.

**Features:** Swivel version with automatic return function to initial position.

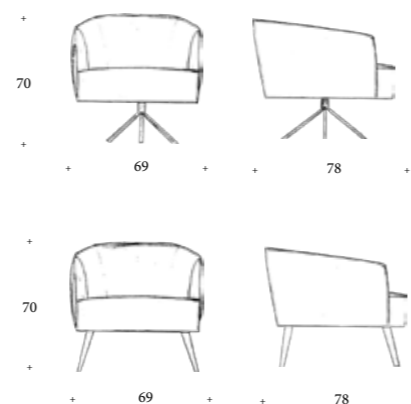



"Kelly": equilibrio fra dettagli di attuale memoria e leggerezza di volumi. Un nuovo concetto di attuale classicità arricchito dall'esclusivo pouf coordinato.

## KELLY

*"Kelly": balance between details of current memory and lightness of volumes. A new concept of modern classicism enriched by the exclusive coordinated pouf.*

### SCHEDA TECNICA

**Imbottitura:** poliuretano espanso indeformabile a densità differenziata e faldina acrilica.

**Struttura:** intelaiatura in legno di varie essenze. Molleggio con cinghie elastiche incrociate, interamente ricoperte e con anima in polipropilene.

**Rivestimento:** tessuto o pelle.

**Sfoderabilità:** nessuna.

**Piedi:** metallo cromato scuro.

### TECH SHEET

**Padding:** different density non-deforming polyurethane foam and acrylic padding.

**Structure:** frame in different kind of wood. Multi-layered flex wood and support with interwoven elastic webbing, completely covered and reinforced with polypropylene.

**Upholstery:** fabric or leather.

**Removable covers:** not available.

**Feet:** dark chromium-plated steel.

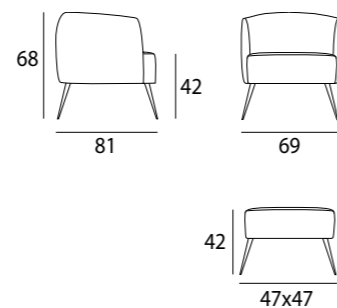







Linee fluide dal segno déco, interpreti di un linguaggio di universale bellezza.

## MIMÌ

*Fluid lines add an art déco touch, interpreting a language of universal beauty.*

### SCHEDA TECNICA

**Imbottitura:** poliuretano espanso indeformabile a densità differenziata.  
**Struttura:** intelaiatura in legno e multistrato flex e molleggio con cinghie elastiche incrociate, interamente ricoperte e con anima in polipropilene.  
**Rivestimento:** tessuto o pelle.  
**Sfoderabilità:** nessuna.  
**Piedi:** metallo cromato scuro.  
**Caratteristica:** opzione con schiena bassa o alta.

### TECH SHEET

**Padding:** different density non-deforming polyurethane foam.  
**Structure:** frame in wood and multi-layered flex wood and support with interwoven elastic webbing, completely covered and reinforced with polypropylene.  
**Upholstery:** fabric or leather.  
**Removable covers:** not available.  
**Feet:** dark chromium-plated steel.  
**Feature:** both low or high backrest available.

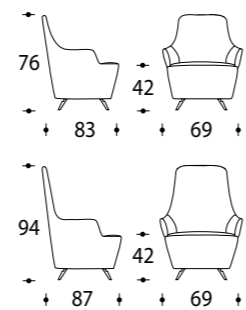







Impuntura a bottone, dal sapore vintage e al tempo stesso moderno: design e comodità misurata.

## VINTAGE

*Button stitching, with a vintage yet modern flavour: measured design and comfort.*

### SCHEDA TECNICA

**Imbottitura:** poliuretano espanso indeformabile a densità differenziata.  
**Struttura:** metallo cromato, legno di faggio e multistrato. Molleggio con cinghie elastiche, interamente ricoperte e con anima in polipropilene.  
**Rivestimento:** pelle.  
**Sfoderabilità:** nessuna.  
**Piedi:** metallo cromato.  
 Caratteristiche: la struttura cromata che ne percorre il profilo, il capitonné di seduta e schiena, e il pouf che la completa.

### TECH SHEET

**Padding:** different density non-deforming polyurethane foam coated.  
**Structure:** chromium-plated steel, beech and multilayer wood. Support with elastic webbing, completely covered and reinforced with polypropylene.  
**Upholstery:** leather.  
**Removable cover:** not available.  
**Feet:** chromium-plated steel.  
**Features:** chromium-plated structure which runs along the shape, the capitonné of the seat and the back, and the footstool which integrates the composition.

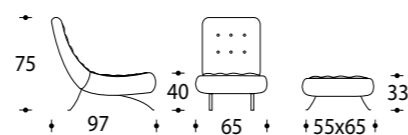







L'antica tecnica capitonné reinterpretata in chiave contemporanea con un basamento girevole in metallo cromato.

## DADA

*The traditional capitonné technique is given a modern flavour with a chrome metal swivel base.*

### SCHEDA TECNICA

**Imbottitura:** poliuretano espanso indeformabile a densità differenziata.

**Struttura:** intelaiatura in legno multistrato e massello di faggio. Molleggio con cinghie elastiche, interamente ricoperte e con anima in polipropilene.

**Rivestimento:** pelle.

**Sfoderabilità:** nessuna.

**Piedi:** base girevole in metallo cromato.

**Caratteristiche:** le linee curve che la rendono avvolgente ed il capitonné di seduta e schiena.

### TECH SHEET

**Padding:** different density non-deforming polyurethane foam.

**Structure:** frame in multilayer wood and solid beech wood. Support with elastic webbing, completely covered and reinforced with polypropylene.

**Upholstery:** leather.

**Removable cover:** not available.

**Feet:** swivel base in chromium-plated steel.

**Features:** curved shapes which make it a bucket seat and the capitonné of the seat and the back.

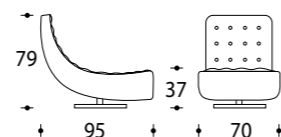



Sfiziosa e avvolgente. Un'idea di comfort riletto secondo un nuovo carattere ironico e contemporaneo. La morbidezza di marlon esprime al meglio la qualità della pelle e della sapiente manualità artigiana.

#### SCHEDA TECNICA

**Imbottitura:** scocca rivestita in poliuretano espanso indeformabile a densità differenziata ricoperto da falda acrilica.

**Struttura:** intelaiatura in legno di varie essenze e molleggio con cinghie elastiche incrociate, interamente ricoperte e con anima in polipropilene.

**Rivestimento:** pelle.

**Sfoderabilità:** nessuna.

**Piedi:** base girevole in metallo cromato scuro.

**Caratteristica:** la seduta morbida e accogliente.

#### TECH SHEET

**Padding:** different density non-deforming polyurethane foam coated with acrylic layer.

**Structure:** frame in different kinds of wood and support with interwoven elastic webbing, completely covered and reinforced with polypropylene.

**Upholstery:** leather.

**Removable cover:** not available.

**Feet:** swivel base in dark chromium-plated steel.

**Feature:** the soft and snug seat.

## MARLON

*Luxurious and enveloping. A concept of comfort reinterpreted with a new, ironic and contemporary character. The softness of the Marlon fully expresses the quality of the leather and the skilful artisanal craftsmanship.*

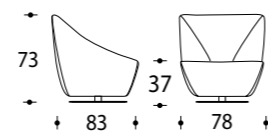



Un guscio avvolgente: un'idea semplice acquisita dalla memoria e riletta secondo un nuovo stile contemporaneo.

## BRITTE

*An enveloping casing: a simple idea taken from memory and given a contemporary twist of style.*

### SCHEDA TECNICA

**Imbottitura:** poliuretano espanso indeformabile a densità differenziata ricoperto da falda acrilica.  
**Struttura:** intelaiatura in legno di varie essenze e molleggio con cinghie elastiche incrociate, interamente ricoperte e con anima in polipropilene.  
**Rivestimento:** pelle.  
**Sfoderabilità:** nessuna.  
**Piedi:** base girevole in metallo cromato.  
**Caratteristica:** le linee curve che la rendono avvolgente.

### TECH SHEET

**Padding:** different density non-deforming polyurethane foam coated with acrylic layer.  
**Structure:** frame in different kinds of wood and support with interwoven elastic webbing, completely covered and reinforced with polypropylene.  
**Upholstery:** leather.  
**Removable cover:** not available.  
**Feet:** swivel base in chromium-plated steel.  
**Feature:** curved shapes which make it a bucket seat.

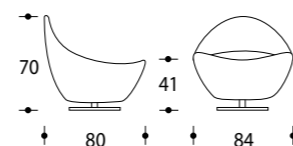



Insolita ed eclettica nella forma è l'espressione di un design raffinato ed esperto. La sua dolce sinuosità, contenuta nelle proporzioni, la rende avvolgente e comoda.

#### SCHEDA TECNICA

**Imbottitura:** poliuretano espanso indeformabile a densità differenziata.

**Struttura:** intelaiatura in legno di varie essenze e molleggio con cinghie elastiche, interamente ricoperte e con anima in polipropilene.

**Rivestimento:** pelle.

**Sfoderabilità:** nessuna.

**Piedi:** metallo cromato.

**Caratteristica:** l'ergonomia di una forma avvolgente e di comfort.

#### TECH SHEET

**Padding:** different density non-deforming polyurethane foam.

**Structure:** frame in different kinds of wood and support with elastic webbing, completely covered and reinforced with polypropylene.

**Upholstery:** leather.

**Removable cover:** not available.

**Feet:** chromium-plated steel.

**Feature:** ergonomic shape for a bucket seat and a maximum comfort.

## SOFIA

*Unusual and eclectic in form, it is the expression of refined and expert design. The soft sinuosity of its proportions makes it comfortable and snugly fitting.*

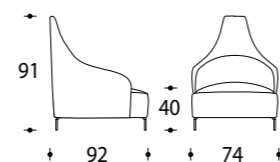



Ricercata, moderna, è un prezioso oggetto di design. Ecco un esclusivo progetto dotato di un'estetica attuale e di un'indiscussa eleganza complementare ad ogni progetto living.

#### SCHEDA TECNICA

**Imbottitura:** scocca rivestita in poliuretano espanso indeformabile a densità differenziata. Cuscino di seduta in poliuretano espanso indeformabile a densità differenziata ricoperto da foderina in piuma canalizzata. Fodera 100% cotone. **Struttura:** intelaiatura in legno di varie essenze e molleggio con cinghie elastiche incrociate, interamente ricoperte e con anima in polipropilene. **Rivestimento:** tessuto e/o pelle. **Sfoderabilità:** totale nella versione in tessuto. **Piedi:** metallo cromato

scuro. **Caratteristica:** l'accostamento tra rigore geometrico della seduta e la leggera eleganza del piedino cromato.

#### TECH SHEET

**Padding:** structure in different density non-deforming polyurethane foam. Seat cushion in different density non-deforming polyurethane foam coated with channeled down duvet. Lining 100% cotton. **Structure:** frame in different kinds of wood and support with interwoven elastic webbing, completely covered and reinforced with

## POLLY

*Desirable, contemporary and a precious design object. This is an exclusive model that reflects the current aesthetic trend and has an incontestable elegance that will enhance any lifestyle project.*

polypropylene. **Upholstery:** fabric or leather. **Removable cover:** fully removable covers in fabric. **Feet:** dark chromium-plated steel. **Feature:** the combination between the geometric rigor of the seat and the light elegance of leg chromium-plated.

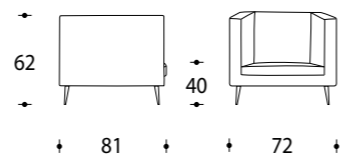



Una struttura di metallo cromato ed una seduta comoda, per un progetto senza tempo d'indiscussa eleganza.

## HARPER

*A chromed steel structure and a comfortable seat, for a timeless project of undisputed elegance.*

### SCHEDA TECNICA

**Imbottitura:** poliuretano espanso indeformabile a densità differenziata.

**Struttura:** metallo cromato, legno di faggio e multistrato. Molleggio con cinghie elastiche incrociate, interamente ricoperte e con anima in polipropilene.

**Rivestimento:** pelle.

**Sfoderabilità:** nessuna.

**Piedi:** metallo cromato.

**Caratteristica:** i braccioli portanti creano l'illusione di una seduta sospesa.

### TECH SHEET

**Padding:** different density non-deforming polyurethane foam.

**Structure:** chromium-plated steel, beech and multilayer wood. Support with interwoven elastic webbing, completely covered and reinforced with polypropylene.

**Upholstery:** leather.

**Removable cover:** not available.

**Feet:** chromium-plated steel.

**Feature:** bearing armrests create the illusion of a suspended seat.

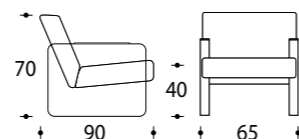



Design classico: una struttura tradizionale e raffinata sostanziata dalla ricerca attenta di ogni dettaglio sartoriale.

## FRED

*Classical design: a traditional and elegant model made with the meticulous research of every last tailored detail.*

### SCHEDA TECNICA

**Imbottitura:** in poliuretano espanso indeformabile a densità differenziata ricoperto da falda acrilica.

**Fodera:** 100% cotone.

**Struttura:** intelaiatura in legno di varie essenze e molleggio con cinghie elastiche incrociate, interamente ricoperte e con anima in polipropilene.

**Rivestimento:** pelle e tessuto.

**Sfoderabilità:** totale nella versione tessuto.

**Piedi:** metallo cromato.

**Caratteristica:** la cucitura che ne disegna il profilo.

### TECH SHEET

**Padding:** in different density non-deforming polyurethane foam coated with acrylic layer.

**Lining:** 100% cotton.

**Structure:** frame in different kinds of wood and support with interwoven elastic webbing, completely covered and reinforced with polypropylene.

**Upholstery:** fabric or leather.

**Removable cover:** fully removable covers in fabric.

**Feet:** chromium-plated steel.

**Feature:** the stitching which draws the contour.

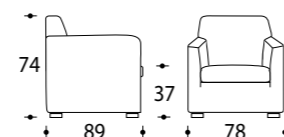



Un design raffinato contenuto nelle proporzioni. Cuciture insolite la rendono unica nel linguaggio della tradizione contemporanea del design.

#### SCHEDA TECNICA

**Imbottitura:** scocca in poliuretano espanso indeformabile a densità differenziata. Cuscino di seduta in poliuretano espanso indeformabile a densità differenziata ricoperto da falda acrilica. Fodera 100% cotone.

**Struttura:** intelaiatura in legno di varie essenze e molleggio con cinghie elastiche incrociate, interamente ricoperte e con anima in polipropilene.

**Rivestimento:** tessuto o pelle.

**Sfoderabilità:** totale nella versione tessuto.

**Piedi:** legno massello verniciato o base girevole in

legno multistrato verniciato. **Caratteristica:** opzione fissa o girevole.

#### TECH SHEET

**Padding:** structure in different density non-deforming polyurethane foam. Seat cushion in different density non-deforming polyurethane foam coated with acrylic padding.

**Lining:** 100% cotton. **Structure:** frame in different kinds of wood and support with interwoven elastic webbing, completely covered and reinforced with polypropylene.

**Upholstery:** fabric or leather.

## CHARLIE

*A sophisticated design in its proportions. Unusual seams make it unique in the language of contemporary design tradition.*

**Removable cover:** fully removable cover in fabric. **Feet:** varnished solid wood or swivel base in varnished multilayer wood. **Feature:** fixed or swivel available.

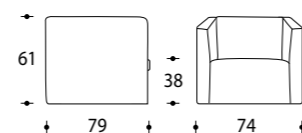



Solida e proporzionata: borghese nel suo stile trasversale, adattabile ad ogni arredo contemporaneo.

#### SCHEDA TECNICA

**Imbottitura:** scocca rivestita da poliuretano espanso. Cuscino di schiena e di seduta in poliuretano espanso indeformabile a densità differenziata ricoperto da falda acrilica. Fodera 100% cotone.  
**Struttura:** intelaiatura in legno di varie essenze e molleggio con cinghie elastiche incrociate, interamente ricoperte e con anima in polipropilene.  
**Rivestimento:** pelle e tessuto.  
**Sfoderabilità:** totale nella versione tessuto.  
**Piedi:** legno massello verniciato.  
**Caratteristica:** le linee

curve che nascono tra l'incontro di schiena e bracciolo addolcendone il profilo.

#### TECH SHEET

**Padding:** structure covered with polyurethane foam. Seat and back cushion in different density non-deforming polyurethane foam coated with acrylic layer. Lining 100% cotton.  
**Structure:** frame in different kinds of wood and support with interwoven elastic webbing, completely covered and reinforced with polypropylene.  
**Upholstery:** fabric or leather.

## ELIOT

*Robust and proportionate: bourgeois in its elongated style, and suited to any contemporary décor.*

**Removable cover:** fully removable cover in fabric.  
**Feet:** varnished solid wood.  
**Feature:** curved shapes drawn between the encounter of the backrest and the armrest giving a sweeter aesthetic.

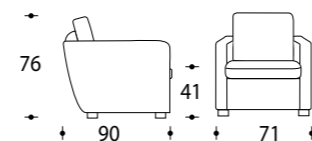







# GURIAN

## **GURIAN spa**

Via delle Querce 7 - 31040 Cessalto/TV - ITALY

Tel. +39 0421 469 111 - Fax +39 0421 469 175

Commerciale Italia +39 0421 469 112

Export +39 0421 469 113

C.F./P.IVA 01140220268

[gurianspa@gurian.it](mailto:gurianspa@gurian.it)

[www.gurian.it](http://www.gurian.it)

## **SHOWROOM**

Via degli Olmi - 31040 Cessalto/TV - ITALY