



Tavoli, madie e sedute

Tables, sideboards
and chairs

Tavoli Tables

Il tavolo è da sempre uno degli elementi d'arredo più amati e vissuti della casa. Non una semplice base d'appoggio ma un luogo dove mangiare, studiare, giocare, vivere. Tavoli fissi e allungabili, multifunzione e trasformabili, minimal o protagonisti dello spazio, con numerose declinazioni e un concept evoluto di intercambiabilità dei piani che consente di abbinare a diverse basi un mondo di top diversi.

Tables has always been one of the most loved and lived furnishing elements in the house. Not one simple support base but a place to eat, study, play, live. Fixed and extendable tables, multifunctional and transformable, minimal or protagonists of the space, with numerous declinations and an advanced concept of interchangeability that allows you to combine a wide selection of tops with different bases.

Madie Sideboards

Protagoniste di ingressi, sale da pranzo e living di nuova generazione, le madie hanno una storia che parte da lontano. Oggi la madia mantiene la sua dimensione funzionale, amplificata da un valore estetico che caratterizza l'intera zona giorno. Le madie di OZZIO ITALIA assolvono alla doppia funzione di contenitore di oggetti quotidiani e ispirazioni creative per dare eleganza e ricercatezza allo spazio.

Protagonists of entrances, dining rooms and living rooms of new generation, sideboards have a history that starts from afar. Today the sideboard keeps its own functional dimension, amplified by an aesthetic value that characterizes the entire living area. The OZZIO ITALIA sideboards fulfill the double function of container for everyday objects and creative inspirations, perfect to give elegance and sophistication to your space.

Sedute Chairs

Se esiste un oggetto che rappresenta il design nella sua accezione più pura, quell'oggetto è la sedia. Sedute con braccioli e senza braccioli, modelli fissi e pieghevoli, girevoli o con meccanismi di ritorno, dalla cucina alla sala da pranzo fino alla zona living. Una varietà espressiva dove forma e sostanza, passione e tecnologia, trovano un unico grande punto d'incontro.





If there is an object that represents design in its purest sense, that object is the chair. Chairs with and without armrests, fixed and folding models, revolving or with return mechanisms, chairs that fit for a kitchen, a dining room and a living area too. Form and substance, passion and technology come together in this expressive variety.













OZZIO[®] ITALIA

01. Company profile













Company profile	
La storia The history	8
Hand crafted Hand crafted	10
Finitura Ceramica e Marble Glass Pyroceram and Marble Glass finishing	12
Finitura Cuoio Leather finishing	16
Finitura Legno Wooden finishing	20
Eco Design Eco Design	24
Partnership creativa Creative Partnership	28

02. Tavoli allungabili



Extendable tables			
	T316 Cirkle	prodotti products 34	scheda tecnica technical sheet 415
	T232 Big Round	42	414
	T314 Veliero	50	419
	T256 Arizona	60	413
	T240 4x4	68	413

	T251 Random	prodotti products 80	scheda tecnica technical sheet 419
	T238 FIL8	88	417
	T254 DNA	96	415
	T258 Pivot	96	418
	T202 Lycos	104	417
	T203 Lycos Legno	104	418
	T310 Eclipse	112	415
	T315 Eclipse Legno	112	416
	T244 Emisfero	120	416
	T236 Emisfero Legno	120	416
	T246 Bombo Allungabile	126	414
	T312 Bravo Allungabile	126	414
	T200 Metrò	134	418













03. Tavoli fissi













Fix tables			
	T234 Gem	prodotti products 146	scheda tecnica technical sheet 424
	T252 Random Fisso	156	428
	T403 Veliero Fisso	166	429
	T402 Cirkle Fisso	166	421
	T401 Big Round Fisso	166	421
	T404 Emisfero Fisso	172	422
	T405 Eclipse Fisso	172	421
	T204 Lycos Fisso	172	425
	T253 Papillon	178	426
	T241 4x4 Fisso	186	420
	T257 Arizona Fisso	186	420
	T237 FIL8 Fisso	198	422













04. Madie

Sideboards			
	X313 Sarah	prodotti products 208	scheda tecnica technical sheet 433
	X311 Giulia	214	431
	X314 Rain	220	432
	X315 Rain Wood	220	432
	X310 Grace	228	431
	X307 Trilogy Duo	234	433
	X302 Brera	240	430
	X312 Brera Vetro	240	431
	X309 Brera TV	248	430
	X306 Armor	254	430
	X308 Plana	260	432

05. Sedute Chairs

		prodotti products	scheda tecnica technical sheet
	S022 Ego	268	437
	S062 Ego BR	268	437
	S013 Juliette	274	440
	S464 Zico	280	445
	S314 Megan	286	441
	S321 Blitz	292	435
	S012 Baia	300	434
	S463 Baia BR	300	434
	S011 Cubix	306	436
	S010 Giotto	314	439
	S341 Frisbee	320	438
	S346 Frisbee BR	320	438

		prodotti products	scheda tecnica technical sheet
	S336 Kite	326	440
	S337 Loren	332	440
	S330 Viva	338	445
	S050 Betta	344	435
	S456 Thelma	350	445
	S058 Sally	356	443
	S059 Sveva	356	444
	S060 Selena	356	443
	S061 Siria	356	443
	S316 Sofia	362	444
	S322 Lunette	368	441
	S053 Olimpia	374	442
	S461 Gilda	374	439

		prodotti products	scheda tecnica technical sheet
	S051 Atena	374	434
	S052 Demetra	374	437
	S453 Delia	380	436
	S462 Halia	380	440
	S452 Eliot	380	438
	S450 Nelson	380	441
	S447 Fiona	386	438
	S460 Zelda	386	445
	S448 Gavia	386	439
	S449 Ten	386	444
	S318 Nexus	392	441
	S208 Plio	398	442
	S215 Ripiego	404	442

06. Informazioni tecniche Technical information

Schede tecniche
Technical sheets

412

Finiture
Finishes

446

Company
profile

Company profile



La storia

The history

La storia di OZZIO ITALIA inizia nel 1961 nella culla di molte eccellenze dell'italian design: il distretto della Brianza a nord di Milano.

Nel primo laboratorio artigiano della famiglia Pozzoli si coltiva la qualità: con questa filosofia e un forte legame con il proprio territorio, l'azienda cresce fino a diventare oggi un brand internazionale, presente con i suoi prodotti in 5 continenti.

La collezione OZZIO ITALIA è contraddistinta da una particolare interpretazione della vita contemporanea, frutto di una visione in grado di raccogliere ispirazioni da tutto il mondo e trasformarle in proposte dall'inconfondibile stile italiano.

OZZIO ITALIA ha posto le basi del proprio sales network internazionale a partire dagli anni 90. Oggi l'azienda è una realtà di riferimento nell'ambito dell'arredamento multifunzione, con una consolidata presenza in Europa, America, Asia e Africa confermata da showroom istituzionali nelle più importanti città del mondo.

The history of OZZIO ITALIA started in 1961, in the cradle of many italian design excellences: the Brianza district, located north of Milano.

In the first artisan workshop of the Pozzoli Family, quality was the first value: with this philosophy and a strong bond with its homeland, the company grows until becoming, today, an international brand, currently available throughout five continents.

The OZZIO ITALIA collection is characterised by a particular interpretation of contemporary lifestyle, fruit of a vision that gathers inspiration from the whole world and transforms it in unmistakably italian design propositions.

OZZIO ITALIA laid its international sales network bases starting from the 90s. Today, the company is a reference reality in multi-functional furniture field, with a consolidated turnout in Europe, America, Asia and Africa, confirmed by the presence in the best showrooms in the most important cities of the world.

Hand crafted

Hand crafted

Tecnologia ed artigianato dialogano insieme per produrre ciò che prima non c'era

Technology and craftsmanship working together to produce what was not there before

Dare risposte nuove agli stili e alle esigenze dell'abitare significa innanzitutto creare metodi per produrre ciò che prima non esisteva. Significa tradurre l'idea di un movimento in una realtà meccanica semplice e affidabile nel tempo. Significa creare i singoli componenti che rendono possibili le sorprendenti trasformazioni dei tavoli. Significa anche portare nel futuro una conoscenza antica di materiali come il legno e il metallo.

Le proposte OZZIO ITALIA sono così innovative che anche i metodi di produzione sono unici: un know-how esclusivo in cui la tecnologia dialoga con le radici di un laboratorio artigiano. Due aspetti che fanno parte della realtà quotidiana di tutti gli addetti altamente specializzati di OZZIO ITALIA, che curano con le proprie mani ogni dettaglio della collezione.

Giving new answer to the styles and needs of modern dwelling means, first of all, to create new ways of making what did not exist. It means to translate the idea of a movement in a mechanical reality, simple and reliable over time. It means to create the single components to make the amazing table transformations possible. It also means to bring along to the future an antique knowledge on materials like wood and metal.

The OZZIO ITALIA propositions are so innovative that also the production methods are unique: an exclusive knowhow where technology empathyzes with the roots of an artisan workshop. Two aspects, both part of every highlyskilled workers at OZZIO ITALIA, handcrafting every detail of the collection.



Finitura Ceramica e Marble Glass

Pyroceram and Marble Glass finishing

Superfici di luce per un lusso quotidiano

Surfaces of light for everyday luxury

Il top di alcuni tavoli così come diversi piani e ante delle madie della collezione OZZIO ITALIA sono rivestiti in ceramica o Marble Glass. Due materiali di valore, per superfici compatte e monolitiche, dal mood naturale, che riflettono la luce dell'ambiente ed esprimono tutta la ricercatezza di un lusso quotidiano che esalta il design dello spazio.

Dal punto di vista tecnico, la ceramica è porcellana laminata ottenuta per macinazione ad umido di materie prime argillose, rocce granitiche, metamorfiche e pigmenti ceramici, compattati e cotti ad altissime temperature per offrire la massima consistenza e durezza. Un materiale completamente naturale e riciclabile, privo di pigmenti organici.

The top of some tables as well as different surfaces and doors of the sideboards from the OZZIO ITALIA collection are covered in ceramic or Marble Glass. Two valuable materials for compact and monolithic surfaces with a natural mood, which reflect the light of the environment and express refinement. A daily luxury that highlights the design of your space.

From a technical point of view, ceramic is laminated porcelain obtained by wet grinding of clayey raw materials, granite and metamorphic rocks and ceramic pigments, all pressed together and cooked at extremely temperatures to offer maximum resistance. Ceramic is a natural and recyclable material, free from organic pigments.



● T237 Fil8 Fisso
tavolo fisso
fix table
CC07



● T240 4x4
tavolo allungabile
extendable table
MG03 MT97

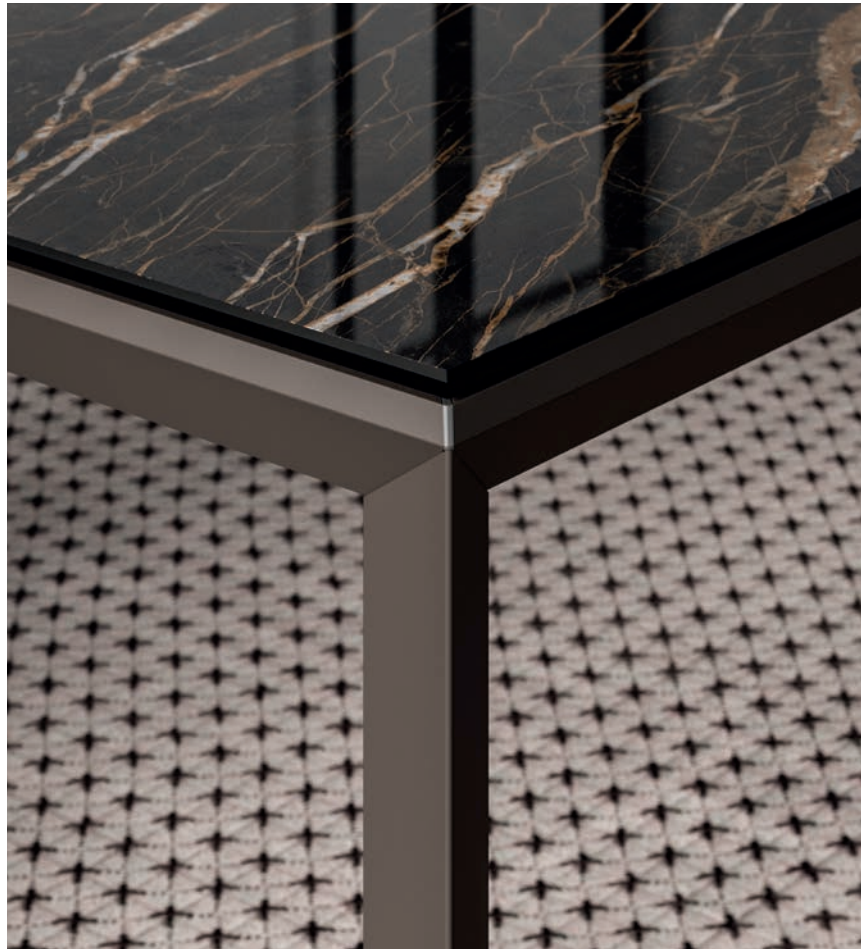

● Ceramica
Pyroceram
CC08



● Marble Glass
Marble Glass
MG05



Mentre il Marble Glass è una finitura in lastra di vetro retro stampato ad effetto marmoreo, che rispetto ai marmi naturali è in grado di restituire un disegno unico su tutta la lastra, senza soluzione di continuità, con una resa cromatica perfetta delle sfumature e un altissimo livello di definizione dei dettagli.

Entrambe le soluzioni sono semplicissime da pulire, hanno una porosità prossima allo zero e non consentono l'insorgere di muffe, batteri e funghi: fattori importanti per garantire l'igiene quotidiana delle superfici e la compatibilità con un utilizzo in cucina o a contatto con cibi e bevande.

In più la ceramica offre elevate performance in termini di resistenza alle abrasioni, agli agenti chimici e al calore. Non cambia colore nel tempo se esposta ai raggi UV ed è perfettamente indeformabile, per un prodotto destinato a durare anni mantenendo intatte le sue caratteristiche estetiche.

On the other hand, Marble Glass is a back-printed glass plate finish with a marble effect which compared to natural marbles is capable of returning a single design over the entire slab, without solution of continuity and with a perfect color rendering of nuances and a very high level of detail definition.

Both ceramic and Marble Glass are super easy to clean, have nearly zero porosity and do not allow the growth of moulds, bacteria and fungi: these are important factors that guarantee maximum hygiene on the surfaces and their compatibility with a daily use in the kitchen or in contact with foods and drinks.

In addition, ceramic offers high performance in terms of resistance to abrasion, chemicals and heat. It does not change color over time when exposed to UV rays and is perfectly non-deformable. A product intended to last for years, keeping its aesthetic characteristics intact.

Finitura Cuoio

Leather finishing

L'eleganza di un fascino senza tempo.

The elegance of a timeless charm

Morbido, traspirante, resistente ed elegante. Grazie alle sue caratteristiche tecniche ed estetiche il cuoio è oggi uno dei materiali più utilizzati nell'ambito dell'interior design. Un prodotto pregiato dal fascino senza tempo, versatile nella sua capacità di adattarsi ai vari ambienti e ai diversi stili dell'abitare.

Il cuoio utilizzato nei complementi d'arredo OZZIO ITALIA è di origine bovina con pellami di prima scelta provenienti da allevamenti dell'Unione Europea all'interno di filiere controllate che garantiscono i massimi livelli di sostenibilità e il minor utilizzo possibile di sostanze tossiche. La pelle grezza viene poi sottoposta alle operazioni di riviera e in seguito alla concia per essere resa durevole, senza alterare la struttura fibrosa originale.

Soft, breathable, durable and stylish. Thanks to its technical and aesthetic characteristics, leather is today one of the most used materials in the interior design field. A precious product with timeless charm, versatile in its ability to adapt to various locations and different styles of living.

The leather used in the OZZIO ITALIA furnishing accessories is of bovine origine, with top quality hides from European Union livestock within controlled supply chains which guarantee the highest levels of sustainability and the lowest possible use of toxic substances. Raw hides are subjected to beamhouse treatments and to leather tanning in order to make them durable, without altering the original fibrous structure.



● S330 Viva
seduta - chair
C14

Dalle sedie alle poltroncine, dai tavoli agli accessori, OZZIO ITALIA impiega il cuoio come rivestimento esclusivo per complementi d'arredo di grande personalità, ideali per arredare sia contesti residenziali che uffici. Il cuoio è particolarmente indicato per il rivestimento di mobili da contatto in quanto caldo e protettivo d'inverno, fresco e non appiccicoso durante il periodo estivo. Un materiale prezioso che esalta sfumature e riflessi e che invecchiando acquisisce ancora più valore, portando i segni distintivi del tempo.

From chairs to armchairs and from tables to accessories, OZZIO ITALIA uses leather as an exclusive covering for furnishing accessories with great personality, ideal for furnishing both residential contexts and offices. Leather is particularly suitable for the covering of furniture as it is warm and protective in winter, cool and not sticky during the summertime. A precious material that enhances nuances and reflections and gain more value as it ages, bearing the hallmarks of the time.

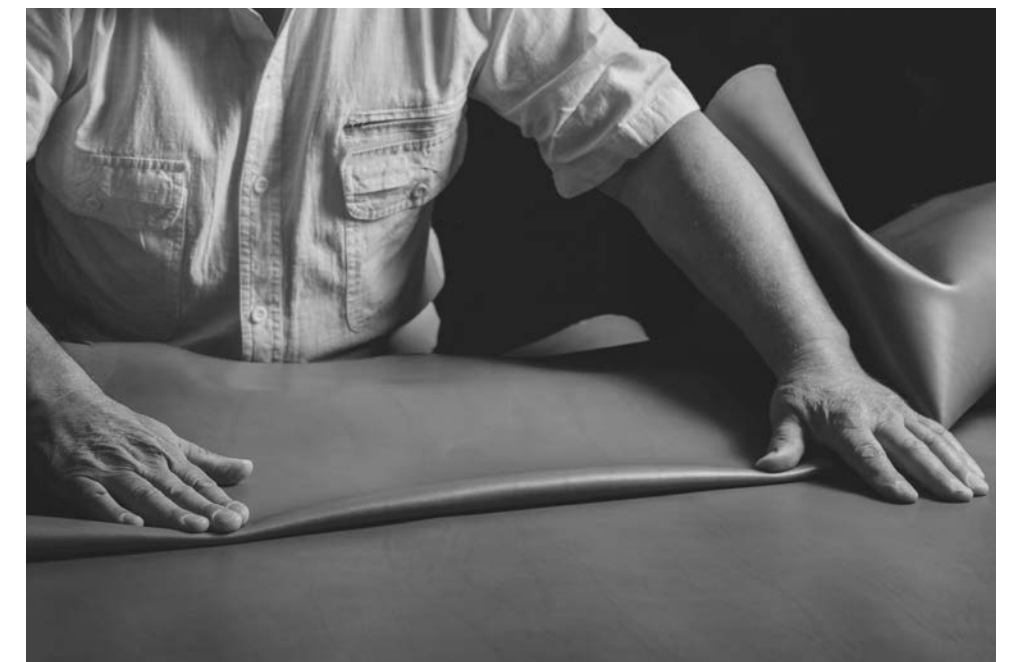

Essendo un prodotto di origine naturale, le possibili piccole imperfezioni come grinze, venature, porosità, cicatrici, rughe, differenze di tonalità, non devono essere considerati difetti bensì un indice di autenticità e assoluta unicità della materia che contraddistingue il vero cuoio da finta pelle, finto cuoio o altri prodotti artificiali.

Since it is a natural product, small imperfections such as creases, veinings, porosity, scars, wrinkles, differences in tone, should not be considered flaws but an index of authenticity and absolute uniqueness for this material and what distinguishes real leather from faux leather and other artificial products.

Finitura Legno

Wooden finishing

Tradizione secolare, stile contemporaneo

Secular tradition, contemporary style

Fin dalla notte dei tempi, il legno è il materiale più impiegato dall'uomo, per costruire, riscaldarsi, proteggersi, arredare. Una sostanza viva che nasce, cresce, si rigenera, in grado di esprimere tutto il calore e il fascino della natura.

La finitura in legno naturale è quella più basic della collezione OZZIO ITALIA. Prodotti realizzati da parti in massello o parti impiallacciate con lastre di vero legno applicate su pannelli in fibra di legno truciolare o polverizzato. La finitura è data da una verniciatura trasparente o coprente che protegge e valorizza l'aspetto naturale del legno. Un trattamento riservato anche al Rovere Vecchio OZZIO ITALIA: una finitura dall'alto valore sostenibile in quanto ricavata da travi portanti invecchiate dal tempo all'interno di vecchi immobili in Italia.

Since the dawn of time, wood has been the most used material by man, to build, heat, protect and furnish. A living substance which is born, grows and regenerates, a living substance able to convey the warmth and charm of nature.

The natural wood finish is the most basic of the OZZIO ITALIA collection. A lot of products are made from solid wood parts or veneered parts with slabs of real wood applied on panels in chipboard or pulverized wood fiber. The finish is given by a transparent or opaque varnish that protects and enhances the natural look of wood. This treatment is also reserved to the OZZIO ITALIA Old Oak: a finish with a high sustainable value obtained from load-bearing beams aged over time inside old properties in Italy.



● T240 4x4
| tavolo allungabile - extendable table
| PZ94

Tutti i prodotti in legno OZZIO ITALIA sono realizzati artigianalmente, uno ad uno, per offrire la massima qualità produttiva e la garanzia di un pezzo unico e inimitabile.

Dai contesti minimal allo stile nordico, dagli ambienti shabby chic a quelli più contemporanei, i complementi d'arredo in legno OZZIO ITALIA trovano spazio in ogni stile d'arredo. I segni e le abrasioni, le diverse tonalità di colore, le nodosità, le stuccature e gli aloni da chiodi e ruggine sono il simbolo distintivo di un materiale naturale che in ogni progetto ha sempre una storia da raccontare.

All OZZIO ITALIA wooden products are handcrafted, one by one, to offer the highest production quality and guarantee unique and inimitable pieces.

From minimal contexts to Nordic style and from shabby chic environments to more contemporary ones, the wooden furniture accessories of OZZIO ITALIA fit in every furnishing style. Signs and abrasions, different shades of color, knottiness, groutings and rusty marks are distinctive symbols of a natural material that always has a story to tell.

● T234 Gem
finitura legno con piano intarsiato
wooden finishing with inlaid top
PZ51



● Lavorazione del legno
| Woodworking



Eco Design

Eco Design

Progettiamo per un futuro sostenibile

We design for a sustainable future

Riciclo, risparmio energetico, auto elettriche e raccolta differenziata non bastano per salvare il nostro pianeta da livelli sempre più alti di inquinamento.

Gli imprenditori e le aziende hanno il dovere di attuare comportamenti a favore dell'ambiente, a partire dal più basso gradino produttivo. Infatti, nelle fasi di progettazione da parte di designer e architetti, il pensiero laterale porta ad approcciare nuove tecniche per la risoluzione di problemi semplici, forme efficienti e funzionali a favore dell'uomo moderno. La riduzione di componenti non necessari e lo snellimento formale porta alla creazione di prodotti di arredamento moderno funzionali e duraturi nel tempo. La chiave di produzioni di qualità porta il consumatore a spezzare l'azione consumistica che irrompe ai giorni nostri.

Recycling, energy saving, electric cars and reusing are not enough to save our planet from ever-rising levels of pollution.

Entrepreneurs and companies have a duty to adopt behaviours to protect the environment, starting from the lowest production step. In fact, in the design phases of designers and architects, lateral thinking leads to approaching new techniques for solving simple problems, efficient and functional forms to work in modern society. The reduction of unnecessary components and formal streamlining leads to the creation of functional and long-lasting modern furnishing products. The emphasis on quality production leads the consumer to shatter the consumerist activity that prevails today.

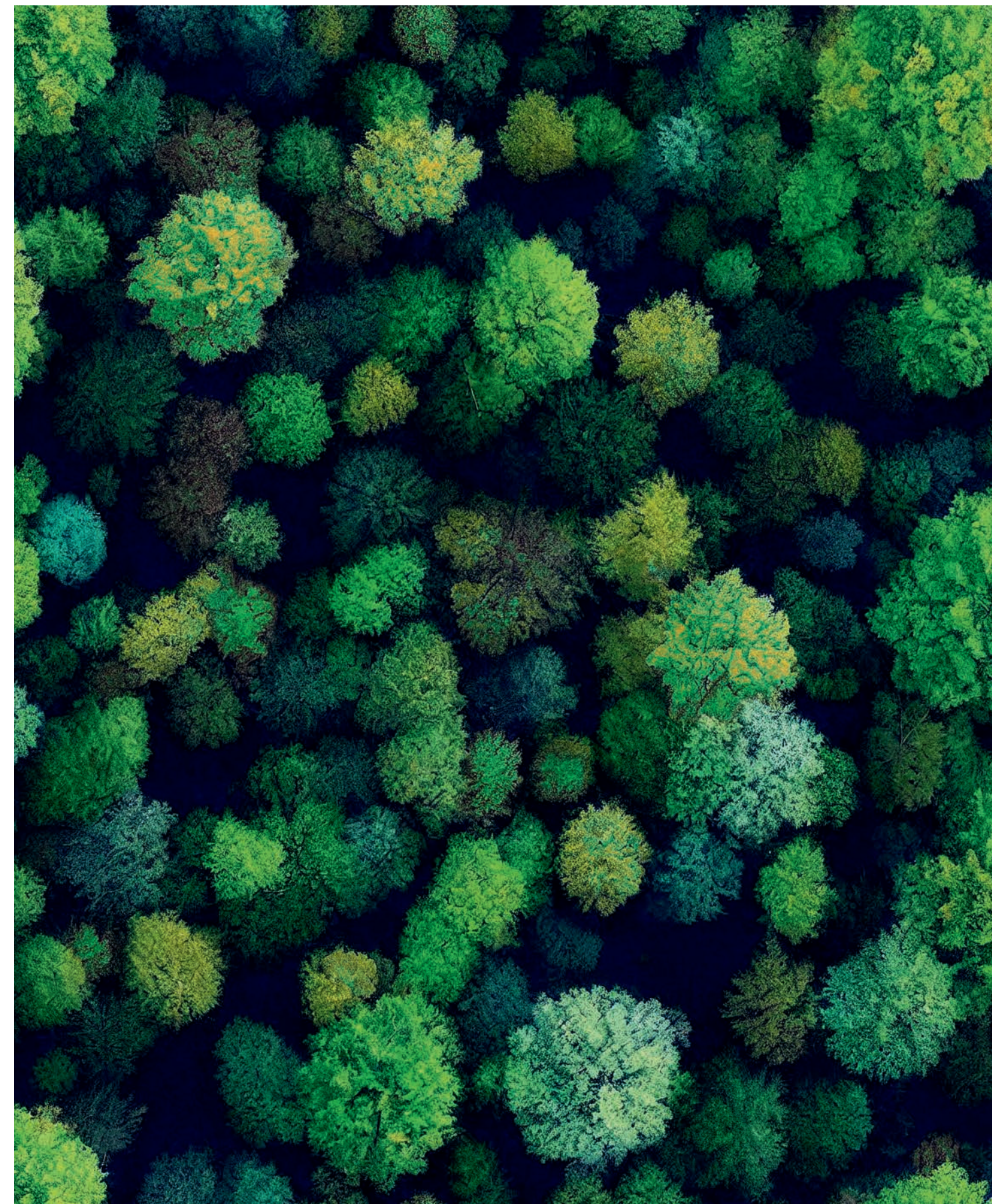



L'obiettivo di OZZIO ITALIA è sempre stato quello di progettare, ricercare, adattare, produrre in una realtà artigiana italiana, conosciuta in tutto il mondo, di prodotti di design sempre più avanzati in grado di rispettare il consumatore e l'ambiente.

OZZIO ITALIA oltre a garantire la lunga vita di tutte le sue collezioni, riduce le emissioni di CO2 del trasporto merci su strada, producendo e assemblando gli arredi il più possibile a km 0. La produzione di articoli prettamente su ordinazione, consente l'abolizione di inutili sprechi produttivi, dedicando il 100% dell'attenzione degli operatori su prodotti affidabili e unici. Molti dei materiali impiegati contengono il 20-40% di materiale riciclato oltre ad essere controllati per ridurre le emissioni di formaldeide, inoltre dopo l'utilizzo possono essere facilmente riutilizzati per nuovi cicli produttivi. Oltre agli arredi, l'azienda utilizza carta per il 70% derivata da materiali riciclati per la stampa dei cataloghi della collezione.

The objective of OZZIO ITALIA has always been to design, research, adapt and produce, in an Italian artisan company that is known all over the world, increasingly advanced design products that respect the consumer and the environment.

OZZIO ITALIA, in addition to guaranteeing the long life of all its collections, reduces CO2 emissions from road freight transport, producing and assembling the furnishings as much as possible at 0 km. The production of purely custom-made items allows for the elimination of unnecessary production waste, devoting 100% of the attention of operators to reliable and unique products. Many of the materials used contain 20-40% recycled material as well as being controlled to reduce formaldehyde emissions, and after use can be easily reused for new production cycles. In addition to furnishings, the company uses 70% paper derived from recycled materials to print the catalogues of the collection.

Comportamenti green

Green behaviors



QUALITÀ CHE DURA NEL TEMPO Quality that lasts over time

Progettazione con materiali ricercati e di qualità che permettono la realizzazione di prodotti che conservano la loro bellezza e funzionalità nel tempo.

Design with refined and quality materials that allow the creation of products that preserve their beauty and functionality over time.



PRODUZIONE A KM 0 Production at 0 KM

Riduzione della filiera produttiva producendo e assemblando gli arredi il più possibile a km 0, basando la sede produttiva in Italia.

Reduction of the production chain by producing and assembling the furnishings as much as possible at 0 km, basing the production site in Italy.



REALIZZATO PER TE Made for you

Produzione solo su ordinazione del consumatore, per ridurre sprechi complessivi e giacenze di magazzino, al fine di dedicare il 100% dell'attenzione ai singoli prodotti.

Production only to the consumer's order, to reduce overall waste and inventory, in order to devote 100% of attention to individual products.

Le nostre certificazioni

Certifications



ETICHETTA FSC FSC label

L'etichetta FSC Misto indica che non meno del 70% della carta all'interno dei cataloghi proviene da materiale certificato FSC, materiale riciclato e/o legno controllato.

The Mixed FSC label indicates that no less than 70% of the paper within the catalogues comes from FSC certified material, recycled material and/or controlled wood.



CERTIFICAZIONE CARB2 CARB2 certification

La certificazione CARB2, ha la finalità di ridurre e controllare le emissioni di formaldeide dai materiali a base legno per proteggere il pubblico dai contaminanti tossici presenti nell'aria.

The purpose of the CARB2 certification is to reduce and control formaldehyde emissions from woodbased materials to protect the public from toxic contaminants in the air.



CERAMICHE LAMINAM Laminam ceramics

Le ceramiche a marchio Laminam contengono il 20-40% di materiale riciclato pre-consumo. Dopo l'utilizzo possono essere facilmente riciclate per nuovi cicli produttivi.

Laminam branded ceramics contain 20-40% pre-consumer recycled material. They can be easily recycled after use for new production cycles.

Partnership creativa

Creative Partnership

Una vera partnership creativa iniziata nel 2005 e che si arricchisce di incontri, progetti, innovazioni sorprendenti.

A real creative partnership started in 2005 that enriches, year by year, of encounters, project, surprising innovations.

La continua collaborazione con designer italiani e di tutto il mondo è fondamentale per l'idea alla base della filosofia OZZIO ITALIA: rivoluzionare l'abitare moderno, definito da spazi sempre più ridotti, creando mobili trasformabili, polifunzionali, con diverse destinazioni d'uso.

The continuous collaboration with italian and worldwide designers is fundamental for the idea at the root of OZZIO ITALIA philosophy: to reinvent the modern living, defined by ever shrinking spaces, creating transformable and multifunctional pieces of furniture, with multiple intended uses.



Davide Carlesi
architetto



Gabriele Cappelletti
architetto



Giuliano Cappelletti
architetto



Giulio Manzoni
architetto



Massimiliano Mornati
architetto



Studio Ozeta
designer team



Andrea Lucatello
architetto



Marco Pozzoli
designer



Luca Roccadria
designer



Luca Tonelli
architetto



Yoshino Toshiyuki
architetto

Tavoli
allungabili



Extendable tables

Piani intercambiabili - tavoli rotondi e allungabili

Interchangeable tops - round and extendable tables

OZZIO ITALIA crede da sempre nella bellezza di un interior design eclettico, fatto di stili, forme e materiali diversi che si mescolano nello spazio dando origine ogni volta a un ambiente unico e distintivo.

Questa idea di dinamismo creativo trova la sua massima espressione concettuale nell'intercambiabilità dei piani delle collezioni dei tavoli OZZIO ITALIA. Molti top dei nostri tavoli possono infatti essere abbinati a molteplici basi offrendo a clienti, designer e architetti infinite possibilità di arredo. Dopo aver scelto la base di tavolo più idonea al proprio progetto è possibile selezionare il piano ideale tra una vastissima gamma di top in cristallo, ceramica, legno e altri materiali. La scelta spazia anche in termini di forme e funzioni del top potendo abbinare tavoli rettangolari, ovali, circolari, fissi o allungabili.

L'intercambiabilità dei piani è una caratteristica distintiva dell'offerta OZZIO ITALIA apprezzata sia per l'ampia scelta iniziale sia per la possibilità futura di cambiare il piano in virtù di nuove esigenze familiari o stilistiche mantenendo sempre la stessa base del tavolo.

OZZIO ITALIA has always believed in the beauty of an eclectic interior design made of different styles, shapes and materials that mix in the space, each time giving rise to a unique and distinctive environment.

This idea of creative dynamism finds its maximum conceptual expression in the interchangeability of the planes of OZZIO ITALIA tables collection. Many tops of our tables can in fact be combined with multiple bases offering to designer, architects and our customers infinite furniture opportunities. After choosing the most suitable table base for your project, you can select the perfect plan among a vast range of tops in crystal, ceramic, wood and other materials. The choice also ranges in terms of shapes and functions of the top being able to combine rectangular, oval, circular, fixed or extendable tables.

The interchangeability of the tops is a distinctive feature for OZZIO ITALIA, appreciated both for the wide initial selection and for the possibility to change the top in the future as a consequence of a family or stylistic need, but still maintaining the same table base.

FLESSIBILITÀ, ALL'ENNESIMA POTENZA
Flexibility, to the nth degree

Piano circolare
Circular top

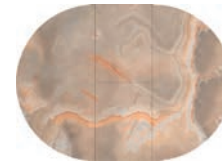

ALLUNGABILE
EXTENDABLE

chiuso - closed
120x120 - 47.2"x47.2"

aperto - open
165x120 - 64.9"x47.2"



ECLIPSE - ECLIPSE LEGNO



EMISFERO - EMISFERO LEGNO



LYCOS - LYCOS LEGNO

Piano ovale
Oval top



ALLUNGABILE
EXTENDABLE

chiuso - closed
120x120 - 47.2"x47.2"

aperto - open
175x120 - 68.8"x47.2"



BRAVO ALLUNGABILE



BOMBO ALLUNGABILE

Piano circolare
Circular top



ALLUNGABILE E ALLARGABILE
EXTENDABLE AND EXPANDABLE

chiuso - closed
130x130 - 51.1"x51.1"

aperto - open
165x165 - 64.9"x64.9"



BIG ROUND



CIRKLE

Piano circolare
Circular top

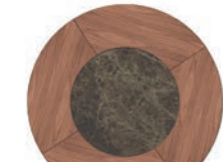

VASSOIO GIREVOLE
SWIVEL TRAY

piano - top
180x180 - 70.8"x70.8"

vassoio - tray
Ø 100 - 39.3"



DNA



PIVOT



VELIERO

Piano rettangolare
Rectangular top



ALLUNGABILE E ALLARGABILE
EXTENDABLE AND EXPANDABLE

chiuso - closed
170x90 - 66.9"x35.4"
200x100 - 78.7"x39.3"

aperto - open
224x118 - 88.1"x46.4"
254x138 - 100"x54.3"



ARIZONA



4x4



RANDOM



FIL8

Piano rettangolare
Rectangular top

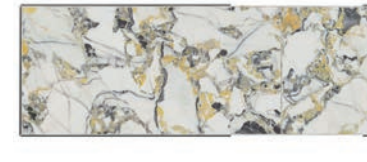

ALLUNGABILE
EXTENDABLE

chiuso - closed
160x85 - 62.9"x33.4"
180x90 - 70.8"x35.4"

aperto - open
259x85 - 101.9"x33.4"
299x90 - 117.7"x35.4"



METRÒ

Cirkle

Design
Studio Ozeta
Marco Pozzoli

Le gambe si inchinano all'eleganza di un cerchio perfetto che dal legno può assumere la consistenza di ogni desiderio. E quando arrivano gli ospiti, in 3 passi il comfort si estende verso un equilibrio solenne tra stabilità e leggerezza con piano e allunghe in legno e la base in metallo. Fino a 10 persone, flessibilità assoluta.

The legs bow to the elegance of a perfect circle that from wood can take on the consistency of every desire. And when the guests arrive, in 3 steps the comfort extends towards a solemn balance of stability and lightness with wooden top and extensions and metal base. Up to 10 people, absolute flexibility.



● T316 Cirkle
tavolo allungabile - extendable table
PZ93 MT97



T316 Cirkle | tavolo allungabile - extendable table | PW94 MT97



● T316 Cirkle
tavolo allungabile - extendable table
PW94 MT97

● S013 Juliette
seduta - chair
EP90 MT97

● X404 Botticelle
lampada - lamp
(5-A) CR14 CR20 CR22

● X306 Armor
madia - sideboard
CC11 MT98

● X042 Sea
specchio - mirror
VS02

TAVOLI ALLUNGABILI | Extendable tables

CIRKLE



La trasformazione di Cirkle
The Cirkle's transformability



Step di apertura caratterizzato da due allunghe centrali dotate di apertura agevolata a slittamento.
Opening step characterized by two central extensions with an easy-sliding opening system.



Ulteriore step di apertura a traslazione indipendente, il top si allarga ulteriormente.
Further opening step with independent translation, the top widens further.



01. Piano chiuso
Closed top



02.



03.



04.



05.



06. Piano aperto
Open top



130x130 H. 77
51.1"x51.1" H. 30.3"



165x165 H. 77
64.9"x64.9" H. 30.3"



chiuso
closed
130
51.1"

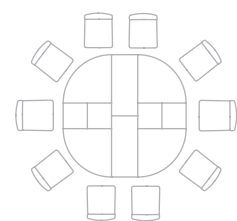

allungamento in larghezza
length extension
step 1 165 - 64.9"

allungamenti in profondità
dept extensions
step 1 130 - 51.1"
step 2 165 - 64.9"

● T316 Cirkle
tavolo allungabile - extendable table
PZ93 MT97

● S463 Baia BR
seduta - chair
P11 PW91



Big Round

Design
Marco Pozzoli
Andrea Lucatello

Il tavolo allungabile Big Round rappresenta l'evoluzione e l'innovazione del meccanismo del tavolo rotondo. Il meccanismo di apertura brevettato è composto da una perfetta sovrapposizione di incastri solidamente trattenuti tra loro. Il sofisticato disegno delle gambe conferisce al prodotto resistenza e personalità. Un'attenzione particolare dedicata alla finitura rovere vecchio naturale esaltata dall'intarsio centrale che si mostra solo a tavolo completamente aperto.

The Big Round extending table represents the evolution and innovation of the round table mechanism. The patented opening mechanism is made up of a perfect overlapping of solidly held joints. The sophisticated design of the legs gives the product strength and personality. Particular attention is paid to the natural old oak finish enhanced by the central inlay that is only visible when the table is fully open.



● T232 Big Round
tavolo allungabile - extendable table
PW91 MT97



T232 Big Round | tavolo allungabile - extendable table | PZ94 MT97



● T232 Big Round
tavolo allungabile - extendable table
PZ94 MT97

● S337 Loren
seduta - chair
C32



● T232 Big Round
tavolo allungabile - extendable table
PZ94 MT97

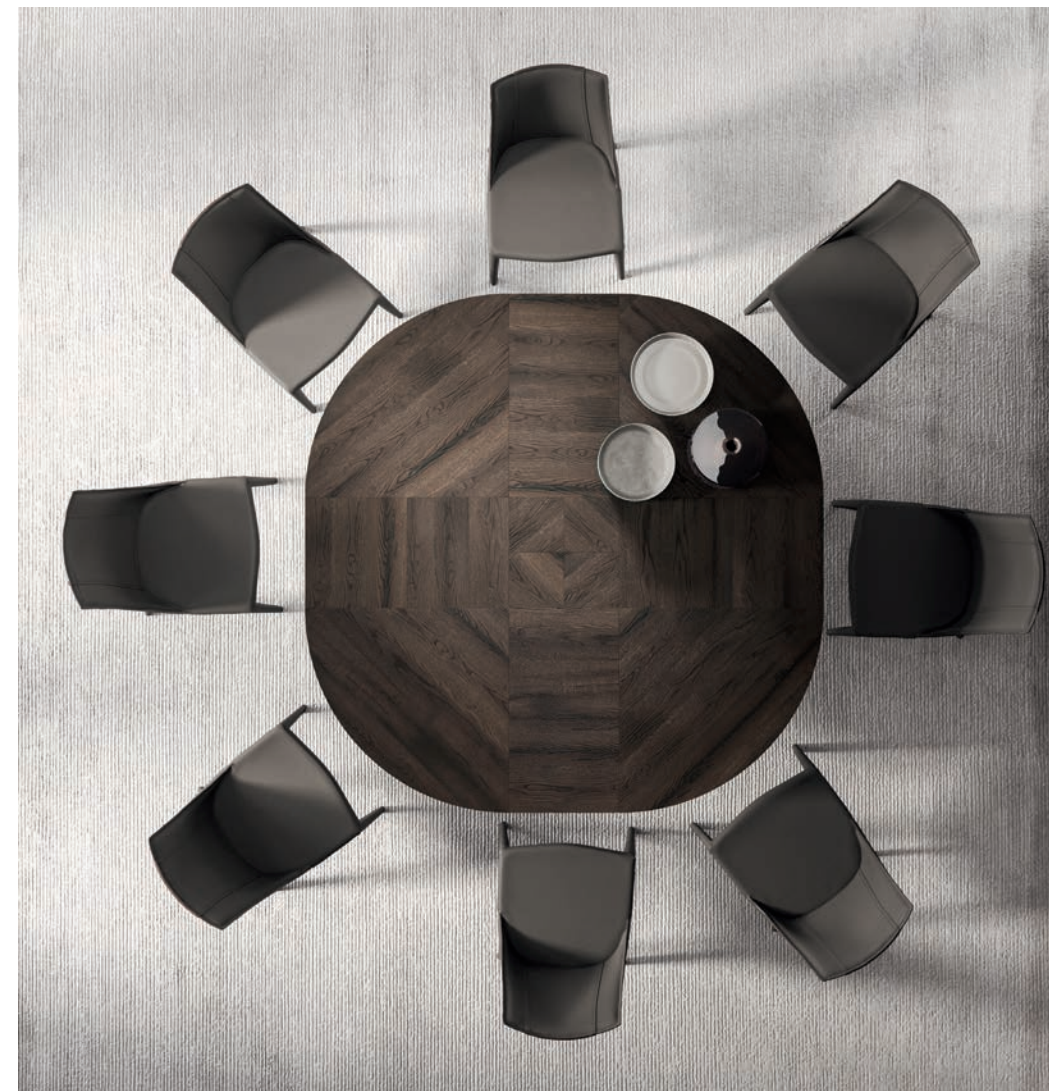



La trasformazione di Big Round

The Big Round's transformability

01. Piano chiuso Closed top

Nella versione chiusa si presenta come uno scultoreo tavolo da pranzo dalle dimensioni contenute atto ad ospitare fino a 6 persone. È rappresentato sia nella versione in Rovere wild che in quella in Rovere vecchio. La diversa direzione di venatura delle due versioni è una pura scelta stilistica.

When closed it looks like a sculptural dining table with small dimensions suitable to accommodate up to 6 people. It is represented in both Wild Oak and Old Oak. The different grain direction of the two versions is a pure stylistic choice.



Rovere wild - Wild oak



Rovere vecchio - Ancient oak

02. Piano semiaperto Semi open top

Il tavolo si estende grazie ad un sistema di allunghe centrali nascoste, trasformandosi fino ad ospitare comodamente 8 commensali. Il primo step è caratterizzato da due allunghe centrali dotate di apertura agevolata a slittamento. Il senso di vena del legno delle allunghe muta a seconda della finitura del top.

The table extends thanks to a system of hidden central extensions. Transforming itself to comfortably accommodate 8 guests. The first step is characterized by two central extensions with an easy-sliding opening system. The direction of the grain changes according to the finishing of the top.

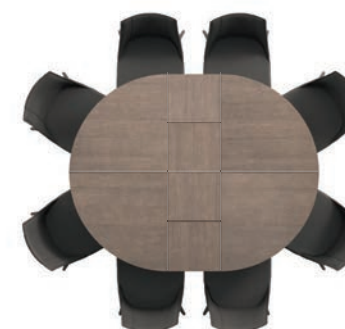

03. Piano aperto Open top

Grazie al sistema brevettato di apertura a traslazione indipendente, il top si allarga ulteriormente e l'allungata centrale esce sorprendentemente allo scoperto creando una geometria raddoppiata rispetto alla partenza, permettendo di ospitare fino a 10 commensali. Una volta completamente aperto il tavolo regala un prezioso intarsio centrale presente solo nelle finiture in Rovere vecchio. (PZ91, PZ93 E PZ94)

Thanks to the opening patented system with independent translation, the top opens wider and the central extension gets out surprisingly, creating a geometry doubled compared to the start position, allowing to accommodate up to ten guests. Once completely open the table gives a precious central inlay available in the Ancient old finishes only. (PZ91, PZ93 AND PZ94)



130x130 H. 77
51.1"x51.1" H. 30.3"



165x165 H. 77
64.9"x64.9" H. 30.3"



chiuso
closed
130
51.1"

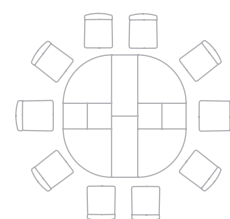

allungamento in larghezza
length extension
step 1 165 - 64.9"

allungamenti in profondità
dept extensions
step 1 130 - 51.1"
step 2 165 - 64.9"

Veliero

Design
Luca Tonelli
Davide Carlesi

Le vele in legno alla base del tavolo seguono il vento di un progetto dinamico, nato per diventare l'icona del tuo living. Solcando il mare della sperimentazione, l'ampia superficie in legno contiene un vassoio Lazy Susan in ceramica. Un giro di vassoio e i piatti viaggiano nella tua direzione. Sull'onda di una nuova esperienza.

The wooden sails at the base of the table follow the wind of a dynamic project, created to become the icon of your living room. Crossing the sea of experimentation, the large wooden surface contains the ceramic Lazy Susan tray. One turn of the tray and the dishes travel in your direction. Riding the wave of a new experience.



● T314 Veliero
tavolo - table
PW91 CC11 PW91





● T314 Veliero
tavolo - table
PW91 CC11 PW91

● S463 Baia BR
seduta - chair
VE05 PW91

● X402 Ring Light
lampada - lamp
PW91 PZ94

● X016 Panto
libreria - bookcase
(D) PW94 CR21 MT97



● T314 Veliero
tavolo - table
PW61 CC07 PW61

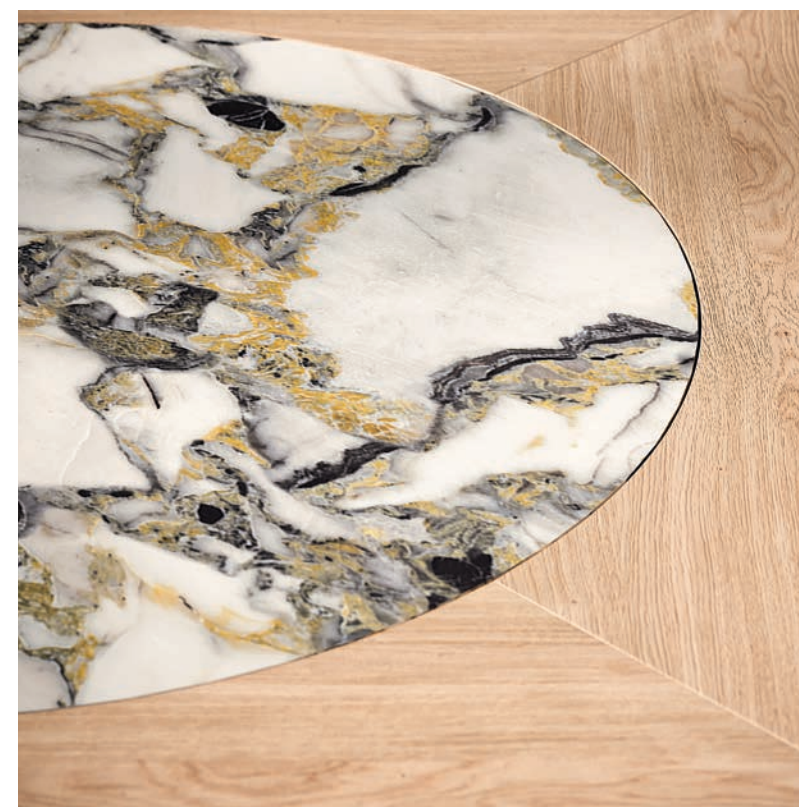

● T314 Veliero
tavolo - table
PW91 CC11 PW91



● T314 Veliero
tavolo - table
PW94 CC10 PW94

● S059 Sveva
seduta - chair
P11 MT97

● X403 Atollo
lampada - lamp
PZ94

● X312 Brera Vetro
madia - sideboard
PW94 CR21 X04 MT98



180x180 H. 76,5
70.8"x70.8" H. 30.1"

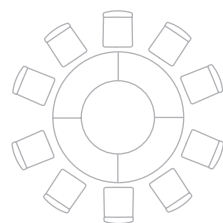
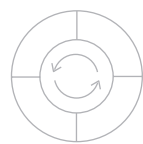

vassoio interno girevole incassato nel piano
swivel tray embedded in the top,

Ø 100
Ø 39.3"

● T314 Veliero
tavolo - table
PW91 CC11 PW91

● S463 Baia BR
seduta - chair
VE03 PW91

Arizona

Design
Giulio Manzoni

Come i rami di un albero capovolto, le gambe si intersecano in un dinamismo materico che lascia ampio spazio e comodità alla tua seduta. Dai rami al tronco, la superficie robusta del tavolo allungabile è rigorosamente in legno per un progetto destinato a inserirsi con estrema naturalezza in qualsiasi contesto abitativo.

As branches of an upside-down tree, the legs intersect in a material dynamism that leaves ample space and comfort to your seat. From the branches to the trunk, the robust surface of the extendable table is rigorously made of wood for a project born to fit naturally into any living context.



● T256 Arizona
tavolo allungabile - extendable table
PZ51 MT97 PZ51



T256 Arizona | tavolo allungabile - extendable table | PW96 MT97 PW96



● T256 Arizona
tavolo allungabile - extendable table
PW96 MT97 PW96

● S341 Frisbee
seduta - chair
C25

● S346 Frisbee BR
seduta - chair
C25

● X404 Botticelle
lampada - lamp
(6-A) CR14 CR22



● T256 Arizona
tavolo allungabile
extendable table
PW96 MT97 PW96

● S341 Frisbee
seduta
chair
C25

● S346 Frisbee BR
seduta
chair
C25

● X404 Botticelle
lampada
lamp
(6-A) CR14 CR22

● X313 Sarah
madia
sideboard
VS01 X17 MT97



170x90 H. 77
66.9"x35.4" H. 30.3"



224x118 H. 77
88.1"x46.4" H. 30.3"



chiuso
closed
170
66.9"

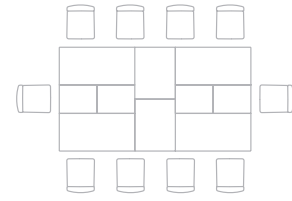

allungamento in larghezza
length extension
224 - 88.1"

allungamento in profondità
dept extension
118 - 46.4"



200x100 H. 77
78.7"x39.3" H. 30.3"

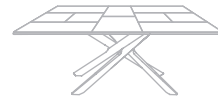

254x138 H. 77
100"x54.3" H. 30.3"

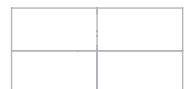

chiuso
closed
200
78.7"

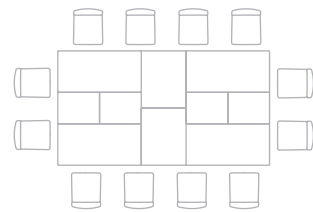

allungamento in larghezza
length extension
254 - 100"

allungamento in profondità
dept extension
138 - 54.3"

● T256 Arizona
tavolo allungabile - extendable table
PW96 MT97 PW96



4x4

Design
Giulio Manzoni

L'innovativo tavolo 4x4 dispone di un sistema di apertura esclusivo. Allungabile e allargabile con basamento incrociato in metallo, piani e allunghe in legno, cemento o Marble Glass, scorrimento guide metalliche. Nella nuova finitura di piano Marble Glass piani e allunghe mantengono continuità nel disegno sia chiuso che aperto.

The new table 4x4 presents an exclusive opening system. The product changes in its shape and its outlook because of the extensions that, once open, cross the veins of top and give an elegant leitmotif. Renewed in the new Marble Glass finish, it maintains continuity in the design both with the table top closed and open.



● T240 4x4
tavolo allungabile - extendable table
PZ91 MT98



T240 4x4 | tavolo allungabile - extendable table | MG03 MT97



● T240 4x4
tavolo allungabile - extendable table
MG03 MT97

● S010 Giotto
seduta - chair
P90 PW96

● X016 Panto
libreria - bookcase
(C-D) PW94 CR14 MT97

● X038 Miami Vice
specchio - mirror
MG03



● T240 4x4
tavolo allungabile
extendable table
MG02 MT98



● T240 4x4
tavolo allungabile - extendable table
PZ91 MT98

● S314 Megan
seduta - chair
P18

● X402 Ring Light
lampada - lamp
PW91



● T240 4x4
tavolo allungabile - extendable table
PZ94 MT97





Un sistema d'apertura esclusivo

An exclusive opening system



170x90 H. 77
66.9"x35.4" H. 30.3"



224x118 H. 77
88.1"x46.4" H. 30.3"



chiuso
closed
170
66.9"



allungamento in larghezza
length extension
224 - 88.1"

allungamento in profondità
dept extension
118 - 46.4"

4x4 adotta un sistema d'apertura innovativo basato sullo scorrimento geometrico dei piani che consentono di passare da cm 100x200 della versione chiusa ad un'estensione di cm 138x254 aperta. La peculiarità del prodotto consiste nell'incrocio delle venature perpendicolarmente che si rivela in un raffinato gioco di superfici lignee. Una solida struttura a sostegni incrociati è realizzata in metallo nelle finiture moda.

4x4 adopts a new opening system based on the geometric scrolling of the tops that makes the table pass from size 100x200 when closed to size 138x254 once open. The peculiarity of the product consists in the veins crossing revealing itself in an elegant play of wooden surface a solid structure made of crossing supports realized in metal in very trendy finishing.



01.

Piano chiuso
Closed top



02.



03.



200x100 H. 77
78.7"x39.3" H. 30.3"



254x138 H. 77
100"x54.3" H. 30.3"



chiuso
closed
200
78.7"



allungamento in larghezza
length extension
254 - 100"

allungamento in profondità
dept extension
138 - 54.3"



04.



05.



06.



07.



08.



09.

Piano completamente allungato
Fully extended top

Random

Design
Giulio Manzoni

Random è un progetto ipnotico e innovativo. Lo sviluppo intrecciato delle sue forme intense rapisce l'osservatore, creando un legame intimo e personale tra dimensione e spazio. Il piano estendibile assicura una funzionalità d'eccellenza. Rinnovato nella nuova finitura in Marble Glass, a piano aperto e a piano chiuso, mantiene continuità nel disegno.

Random is an ipnotic and innovative design. The braided development of its intense shapes takes the attention of the observer, creating an intimal and personal bond between dimension and space. The extendable top guarantees an excellent functionality. Renewed in the new Marble Glass finish, it maintains continuity in the design both with the table top closed and open.



● T251 Random
tavolo allungabile - extendable table
MG04 MT98



T251 Random | tavolo allungabile - extendable table | MG05 MT97



● T251 Random
tavolo allungabile - extendable table
MG05 MT97

● S336 Kite
seduta - chair
C32

● X308 Plana
madia - sideboard
MG05 MT98

● X038 Miami Vice
specchio - mirror
MG05 MG02



● T251 Random
tavolo allungabile - extendable table
MG04 MT97

● S336 Kite
seduta - chair
C32



TAVOLI ALLUNGABILI | Extendable tables

RANDOM



170x90 H. 76,5
66.9"x35.4" H. 30.1"



224x118 H. 76,5
88.1"x46.4" H. 30.1"

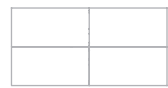

chiuso
closed
170
66.9"

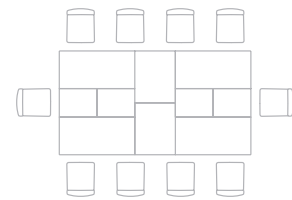

allungamento in larghezza
length extension
224 - 88.1"

allungamento in profondità
dept extension
118 - 46.4"



200x100 H. 76,5
78.7"x39.3" H. 30.1"

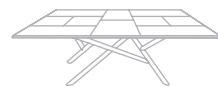

254x138 H. 76,5
100"x54.3" H. 30.1"



chiuso
closed
200
78.7"

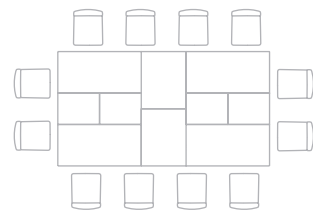

allungamento in larghezza
length extension
254 - 100"

allungamento in profondità
dept extension
138 - 54.3"

● T251 Random
tavolo allungabile - extendable table
PW94 MT98



FIL8

Design
Giulio Manzoni

Un tavolo allungabile che presenta un design elegante, la sua struttura essenziale e "leggera" sostiene un piano costituito in settori di notevole estensione. Una soluzione rappresentativa per un'area pranzo di alte prestazioni grazie alle sue funzioni di allungamento in lunghezza e larghezza.

An extendable table that has an elegant design, its essential and "light" structure supports a top made up of sectors of considerable extension. A representative solution for a high-performance dining area thanks to its functions of elongation in length and width.



● T238 FIL8
tavolo allungabile - extendable table
PW97 MT98



T238 FIL8 | tavolo allungabile - extendable table | PZ93 MT12



● T238 FIL8
| tavolo allungabile - extendable table
| PZ93 MT12





170x90 H. 74,5
66.9"x35.4" H. 29.3"



224x118 H. 74,5
88.1"x46.4" H. 29.3"



chiuso
closed
170
66.9"



allungamento in larghezza
length extension
224 - 88.1"

allungamento in profondità
dept extension
118 - 46.4"



200x100 H. 74,5
78.7"x39.3" H. 29.3"



254x138 H. 74,5
100"x54.3" H. 29.3"



chiuso
closed
200
78.7"

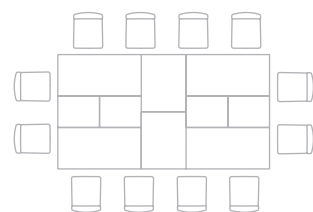

allungamento in larghezza
length extension
254 - 100"

allungamento in profondità
dept extension
138 - 54.3"

● **T238** FIL8
tavolo allungabile - extendable table
PZ93 MT12

● **S316** Sofia
seduta - chair
P90



Famiglia 4x4

4x4 Family

L'innovativo sistema di trasformazione dei piani dotati di allunghe che ne permettono l'allungabilità oltre che l'allargabilità, è sfruttato al massimo nelle sue differenti versioni grazie all'accompagnamento di basamenti di design.

I piani sono caratterizzati da diversi materiali, come il legno, le cui venature naturali formano disegni perpendicolari a tavolo completamente aperto. Mentre nella finitura Marble Glass piani e allunghe mantengono continuità nel disegno sia chiuso che aperto.

The innovative transformation system of table tops equipped with extensions, which allow them to be extended as well as enlarged, is exploited to the full in its different versions thanks to the accompaniment of designer bases.

The tops are characterised by different materials, such as wood, whose natural grain forms perpendicular patterns when the table is fully open. While in the Marble Glass finish, tops and extensions maintain continuity in the design both closed and open.



ARIZONA
piano chiuso - closed top



4x4
piano chiuso - closed top



RANDOM
piano chiuso - closed top



FIL8
piano chiuso - closed top

TRASFORMAZIONI DEL PIANO Top Transformations



01. PIANO IN LEGNO Wooden top chiuso - closed



aperto - open



02. PIANO IN MARBLE GLASS Marble Glass top chiuso - closed

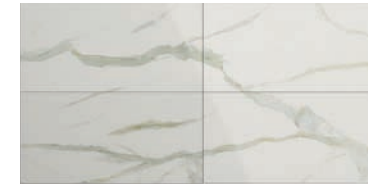

aperto - open



03. PIANO IN CEMENTO Cement top chiuso - closed



aperto - open

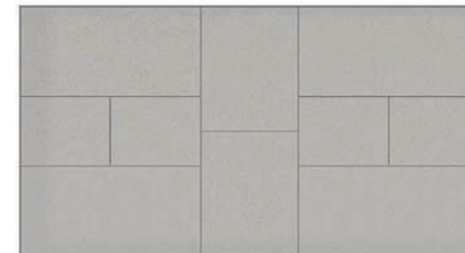

DNA • Pivot

DNA Design
Andrea Lucatello

Pivot Design
Studio Ozeta
Marco Pozzoli

Forme concentriche che si riassumono in un funzionale vassoio girevole Lazy Susan. I tavoli DNA e Pivot offrono la rotazione del piano in ceramica che permette a tutti i commensali di socializzare ed interagire. Il disco centrale è impreziosito dalle finiture in ceramica e circondato da un top in legno.

Concentric shapes that are summarized in a functional Lazy Susan revolving tray. The DNA and Pivot tables offer the rotation of the ceramic top which allows all diners to socialize and interact. The central disk is enriched with ceramic finishes and surrounded by a wooden top.



● T254 DNA
tavolo - table
PZ51 CC10 MT98



● T258 Pivot
tavolo - table
PW94 CC08 MT98



T254 DNA | tavolo - table | PZ51 CC10 MT98



● T254 DNA
tavolo - table
PZ51 CC10 MT98

● S456 Thelma
seduta - chair
P11 PZ51

● X306 Armor
madia - sideboard
CC10 MT98



● T254 DNA
tavolo - table
PZ51 CC10 MT98

● S456 Thelma
seduta - chair
P11 PZ51



DNA



180x180 H. 74
70.8"x70.8" H. 29.1"

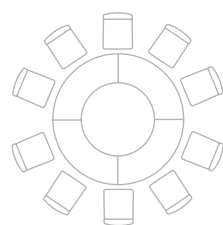
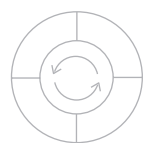

vassoio interno girevole incassato nel piano
swivel tray embedded in the top

Ø 100
Ø 39.3"

PIVOT



180x180 H. 74
70.8"x70.8" H. 29.1"

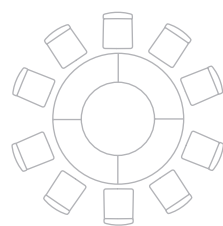
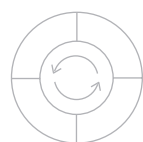

vassoio interno girevole incassato nel piano
swivel tray embedded in the top

Ø 100
Ø 39.3"

● T258 Pivot
tavolo - table
PW94 CC08 MT98

● S062 Ego BR
seduta - chair
B02 MT98



Lycos

Lycos Legno

Design
Marco Pozzoli

Nella scacchiera del tuo progetto di living, il concept Lycos evoca la forma di un alfiere, dominando la scena con solida eleganza. Il top è rotondo, pronto a estendersi verso nuove esperienze. Un tavolo scolpito sulle esigenze del tuo quotidiano con piani e allunghe disponibili in molteplici materiali, anche a tutto legno. Per te e i tuoi ospiti, scacco matto.

In the chessboard of your living room project, the Lycos concept evokes the shape of a bishop, dominating the scene with solid elegance. The top is round, ready to extend to new experiences. A table sculpted on your everyday needs, with tops and extensions available in multiple materials, allwood too. For you and your guests, checkmate.



● T203 Lycos Legno
tavolo allungabile - extendable table
PZ51 MT98

T202 Lycos | tavolo allungabile - extendable table | MG05 CM62





● T202 Lycos
tavolo allungabile - extendable table
MG05 CM62

● S010 Giotto
seduta - chair
P19 PW96

● X402 Ring Light
lampada - lamp
PZ94

● X309 Brera TV
madia - sideboard
(B) PW96 X06 MT98



● T202 Lycos
| tavolo allungabile - extendable table
| MG05 CM62



120x120 H. 74.5/75.5
47.2"x47.2" H. 29.3"/29.7"

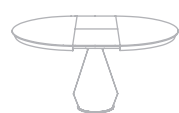

165x120 H. 74.5/75.5
64.9"x47.2" H. 29.3"/29.7"



chiuso
closed
120
47.2"



allungamento in larghezza
length extension
165
64.9"

● T203 Lycos Legno
tavolo allungabile
extendable table
PZ51 MT98

● S060 Selena
seduta
chair
B04 PZ51



Eclipse Eclipse Legno

Design
Studio Ozeta

Eclipse ed Eclipse Legno con un design a tutto tondo per un tavolo minimal, sobrio ed elegante. L'affusolata base centrale disimpegna lo spazio sotto al piano per un maggior comfort. Un'allunga celata al suo interno permette di accogliere fino a 8 persone.

Eclipse and Eclipse Legno have a well-round design that create a minimal, plain and elegant table. The tapered central base frees up the space under the top for greater comfort. An hidden extension allows you to accommodate up to 8 people.



● T315 Eclipse Legno
tavolo allungabile - extendable table
PW96 MT97



T310 Eclipse | tavolo allungabile - extendable table | MG02 MT12



● T310 Eclipse
tavolo allungabile - extendable table
MG02 MT12

● S314 Megan
seduta - chair
P04

● X035 Soho
specchio - mirror
X03 X04

● X307 Trilogy Duo
madia - sideboard
P90 X17 MT97



● **T315 Eclipse Legno**
| tavolo allungabile - extendable table
| PW96 MT97

● **S314 Megan**
| seduta - chair
| P20



120x120 H. 75/76
47.2"x47.2" H. 29.5"/29.9"



165x120 H. 75/76
64.9"x47.2" H. 29.5"/29.9"



chiuso
closed
120
47.2"

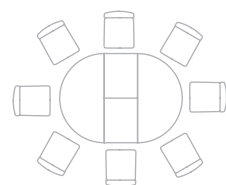

allungamento in larghezza
length extension
165
64.9"

● T310 Eclipse
tavolo allungabile - extendable table
MG02 MT12



Emisfero Emisfero Legno

Design
Gabriele Cappelletti
Studio Ozeta

Raffinate geometrie che si combinano ad un gradevole motivo estetico. Materiali pregiati sostenuti da una struttura che gioca sul tema dell'equilibrio, donando un piacevole movimento all'ambiente circostante. Disponibile in numerose varietà di finiture e dalle discrete dimensioni, Emisfero non incontra difficoltà nel farsi spazio nel living domestico.

Refined geometries that combine with a pleasant aesthetic motif. Precious materials supported by a structure that plays on the theme of balance, giving a pleasant movement to the surrounding environment. Available in numerous varieties of finishes and with moderate dimensions, Emisfero does not encounter difficulties in getting space for itself in the domestic living.



● T244 Emisfero
tavolo allungabile - extendable table
MG03 MT98



T236 Emisfero Legno | tavolo allungabile - extendable table | PZ51 MT97



● T236 Emisfero Legno
tavolo allungabile - extendable table
PZ51 MT97

● S322 Lunette
seduta - chair
VE03



120x120 H. 76/77
47.2"x47.2" H. 29.9"/30.3"



165x120 H. 76/77
64.9"x47.2" H. 29.9"/30.3"



chiuso
closed
120
47.2"



allungamento in larghezza
length extension
165
64.9"

● T244 Emisfero
tavolo allungabile - extendable table
MG03 MT98

● S022 Ego
seduta - chair
EP14 MT98



Bombo • Bravo

ALLUNGABILE ALLUNGABILE

Bombo Allungabile Design
Gabriele Cappelletti
Studio Ozeta

Bravo Allungabile Design
Studio Ozeta

Tavoli dalla forte personalità con morbide linee che nascondono prestazioni eccezionali. Le loro naturali presentazioni sono abbinate a sedie dalle linee morbide ed avvolgenti. I basamenti impreziosiscono i pregevoli piani in ceramica o cristallo antimpronta dotati di allunga interna per accogliere fino a 10 persone.

Tables with a strong personalities and soft lines that hide exceptional performance. Their natural combinations are with chairs characterize by soft and enveloping lines. The bases embellish the precious tops in ceramic or antifingerprint glass. Equipped with an internal extension to accommodate up to 10 people.



T246 Bombo Allungabile
CR18 MT98



T312 Bravo Allungabile
CC11 MT97



T312 Bravo Allungabile | tavolo allungabile - extendable table | CC11 MT97



● T312 Bravo Allungabile
tavolo allungabile - extendable table
CC11 MT97

● S316 Sofia
seduta - chair
B01

● X405 Sole
lampada - lamp
(6) X18

● X311 Giulia
madia - sideboard
VB01 X17 MT97

● X041 Raggio
specchio - mirror
VB01

TAVOLI ALLUNGABILI | Extendable tables

BOMBO ALLUNGABILE • BRAVO ALLUNGABILE



La trasformazione del piano

The transformation of the top

PIANO IN CERAMICA
Pyroceram top
chiuso - closed



aperto - open



Vena continua da chiuso per le finiture in ceramica
e allunga in nobilitato in tinta con la base.

Continuous vein when closed for ceramic finishing
and melamine extension matching with the color
of the base.



BOMBO ALLUNGABILE



120x120 H. 76
47.2"x47.2" H. 29.9"



175x120 H. 76
68.8"x47.2" H. 29.9"



chiuso
closed
120
47.2"

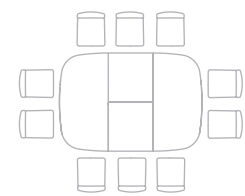

allungamento in larghezza
length extension
175
68.8"

BRAVO ALLUNGABILE



120x120 H. 75
47.2"x47.2" H. 29.5"



175x120 H. 75
68.8"x47.2" H. 29.5"



chiuso
closed
120
47.2"

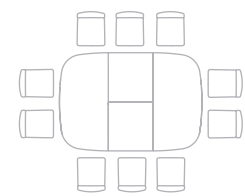

allungamento in larghezza
length extension
175
68.8"

● **T246 Bombo Allungabile**
tavolo allungabile - extendable table
CR18 MT98

● **S316 Sofia**
seduta - chair
EP13



Metrò

Design
Toshiyuki Yoshino
Studio Ozeta

Metrò è un tavolo dalle grandi prestazioni, caratterizzato da un disegno lineare ed essenziale. L'allunga a scomparsa sotto il piano consente di raggiungere dimensioni rilevanti, interpretando il design contemporaneo con carattere e stile made in Italy. Le superfici dei piani ceramica sono valorizzate da calde venature, sempre diverse, per un unicum di straordinaria bellezza.

Metrò is a high-performance table, characterized by a linear and essential design. The retractable extension under the top allows you to reach significant dimensions, making the contemporary design with made in Italy character and style. The surfaces of the ceramic tops are enhanced by warm veinings, always different, for a unicum of extraordinary beauty.



● T200 Metrò
tavolo allungabile - extendable table
CC08 MT97



T200 Metrò | tavolo allungabile - extendable table | CC08 MT97



● T200 Metrò
tavolo allungabile - extendable table
CC08 MT97

● S460 Zeldà
seduta - chair
P20 MT97

● X302 Brera
madia - sideboard
PW94 X17 MT98



● T200 Metrò
tavolo allungabile
extendable table
CC08 MT97



160x85 H. 75
62.9"x33.4" H. 29.5"



259x85 H. 75
101.9"x33.4" H. 29.5"



chiuso
closed
160
62.9"



allungamenti in larghezza
length extensions
step 1 220 - 86.6"
step 2 259 - 101.9"

con allunga supplementare optional
with optional additional extension



180x90 H. 75
70.8"x35.4" H. 29.5"



299x90 H. 75
117.7"x35.4" H. 29.5"



chiuso
closed
180
70.8"



allungamenti in larghezza
length extensions
step 1 250 - 98.4"
step 2 299 - 117.7"

con allunga supplementare optional
with optional additional extension

● **T200 Metrò**
tavolo allungabile - extendable table
CC11 MT98

● **S321 Blitz**
seduta - chair
VE05



Tavoli fissi

Fix tables

Piani intercambiabili - tavoli fissi

Interchangeable tops - fix tables

OZZIO ITALIA crede da sempre nella bellezza di un interior design eclettico, fatto di stili, forme e materiali diversi che si mescolano nello spazio dando origine ogni volta a un ambiente unico e distintivo.

Questa idea di dinamismo creativo trova la sua massima espressione concettuale nell'intercambiabilità dei piani delle collezioni dei tavoli OZZIO ITALIA. Molti top dei nostri tavoli possono infatti essere abbinati a molteplici basi offrendo a clienti, designer e architetti infinite possibilità di arredo. Dopo aver scelto la base di tavolo più idonea al proprio progetto è possibile selezionare il piano ideale tra una vastissima gamma di top in cristallo, ceramica, legno e altri materiali. La scelta spazia anche in termini di forme e funzioni del top potendo abbinare tavoli rettangolari, ovali, circolari, fissi o allungabili.

L'intercambiabilità dei piani è una caratteristica distintiva dell'offerta OZZIO ITALIA apprezzata sia per l'ampia scelta iniziale sia per la possibilità futura di cambiare il piano in virtù di nuove esigenze familiari o stilistiche mantenendo sempre la stessa base del tavolo.

OZZIO ITALIA has always believed in the beauty of an eclectic interior design made of different styles, shapes and materials that mix in the space, each time giving rise to a unique and distinctive environment.

This idea of creative dynamism finds its maximum conceptual expression in the interchangeability of the planes of OZZIO ITALIA tables collection. Many tops of our tables can in fact be combined with multiple bases offering to designer, architects and our customers infinite furniture opportunities. After choosing the most suitable table base for your project, you can select the perfect plan among a vast range of tops in crystal, ceramic, wood and other materials. The choice also ranges in terms of shapes and functions of the top being able to combine rectangular, oval, circular, fixed or extendable tables.

The interchangeability of the tops is a distinctive feature for OZZIO ITALIA, appreciated both for the wide initial selection and for the possibility to change the top in the future as a consequence of a family or stylistic need, but still maintaining the same table base.

FLESSIBILITÀ, ALL'ENNESIMA POTENZA Flexibility, to the nth degree

Piano circolare
Circular top



150x150 - 59"x59"



BIG ROUND FISSO



CIRKLE FISSO



ECLIPSE FISSO



EMISFERO FISSO



LYCOS FISSO



VELIERO FISSO

Piano ovale
Oval top



220x110 - 86.6"x43.3"
240x120 - 94.4"x47.2"
260x120 - 102.3"x47.2"



FIL8 FISSO



GEM



PAPILLON



RANDOM FISSO

Piano ovale intarsiato
Inlaid oval top



260x120 - 102.3"x47.2"



4X4 FISSO



ARIZONA FISSO



FIL8 FISSO



GEM



PAPILLON



RANDOM FISSO

Piano rettangolare
Rectangular top



180x90 - 70.8"x35.4"
200x100 - 78.7"x39.3"
240x110 - 94.4"x43.3"



FIL8 FISSO



GEM



PAPILLON



RANDOM FISSO

Piano rettangolare
Rectangular top



220x110 - 86.6"x43.3"

bordo H. 6,2 - H. 2.4" edge



4X4 FISSO



FIL8 FISSO



RANDOM FISSO

Piano rettangolare
Rectangular top



220x110 - 86.6"x43.3"

bordo H. 6,2 - H. 2.4" edge



4X4 FISSO



ARIZONA FISSO



FIL8 FISSO



RANDOM FISSO

Gem

Design
Andrea Lucatello

La semplicità dei diversi piani fluttuanti del tavolo Gem, bordo con molatura incrociata doppia bisellatura, celebrano l'essenziale dinamicità del basamento in metallo in doppia nuance cromatica o tinta unica. Il possente incastro geometrico della struttura centrale focalizza l'attenzione dell'ambiente e conferisce a questo arredo una personalità unica.

The simplicity of the different glass tops of the Gem table, with a double shaped beveled cross grinding edge and a straight ground polished edge, highlight the essential dynamism of the metal base in a double chromatic nuance or single color. The powerful geometric interlocking of the metal base attracts the attention of the living and gives this furniture a unique personality.



piano in vetro - glass top



piano in Marble Glass - Marble Glass top



piano intarsiato - inlaid top

● T234 Gem
| tavolo fisso - fix table

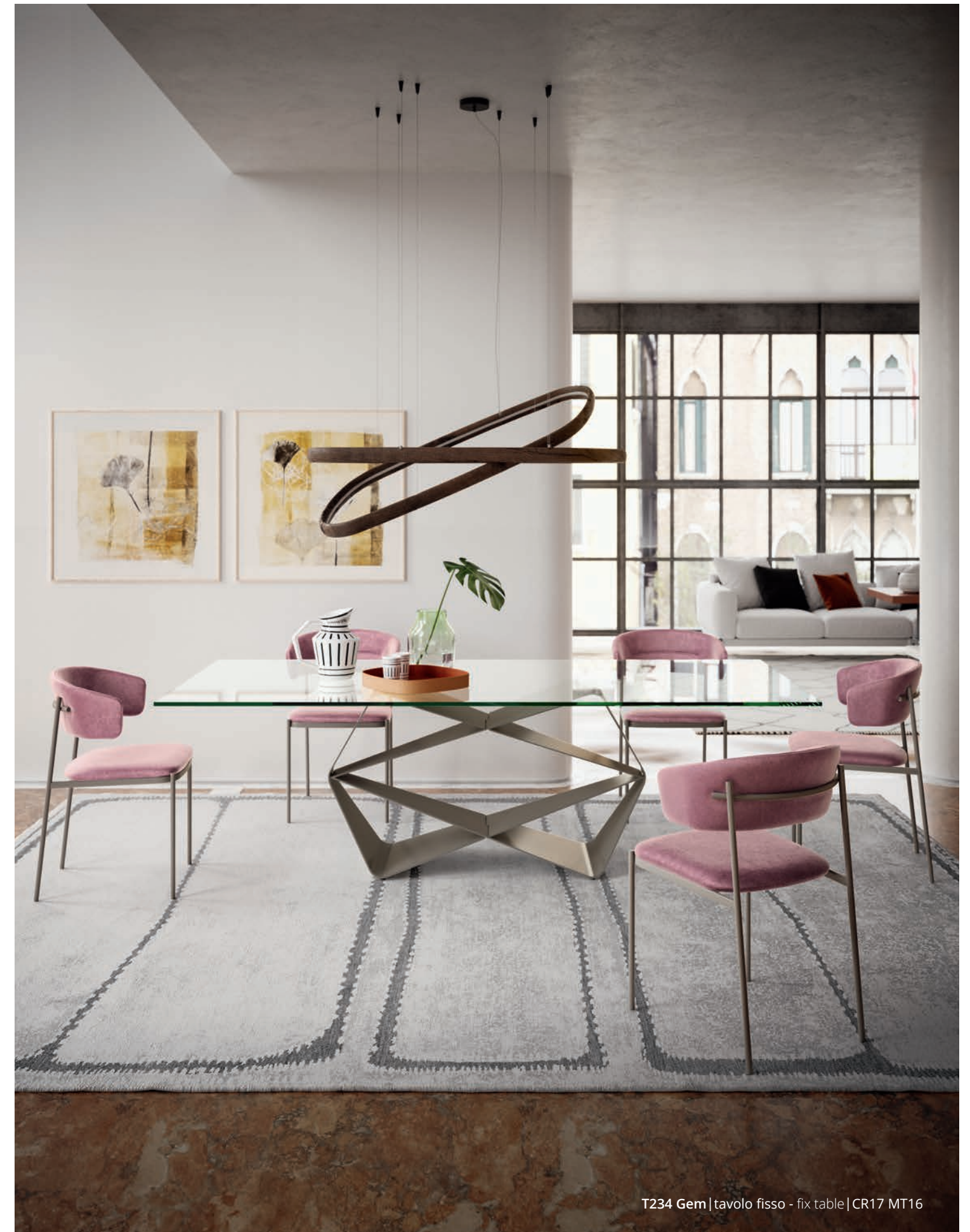

T234 Gem | tavolo fisso - fix table | CR17 MT16



● T234 Gem
tavolo fisso - fix table
CR17 MT16

● S062 Ego BR
seduta - chair
VE01 MT16

● X403 Atollo
lampada - lamp
PZ94



● T234 Gem
tavolo fisso
fix table
CR17 MT16 & MT97

● S336 Kite
seduta
chair
C30





● T234 Gem
tavolo fisso - fix table
PZ51 MT97

● S013 Juliette
seduta - chair
EP15 MT97

● X403 Atollo
lampada - lamp
PW91



piani rettangolari
rectangular top



180x90 H. 74,5
70.8"x35.4" H. 29.3"

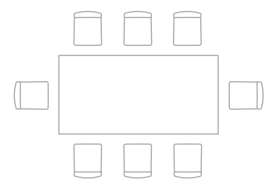

200x100 H. 74
78.7"x39.3" H. 29.1"

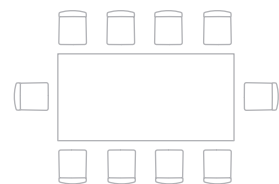

240x110 H. 74
94.4"x43.3" H. 29.1"

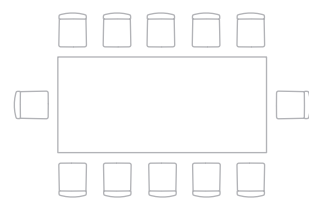

piano ovale
oval top



220x110 H. 74
86.6"x43.3" H. 29.1"

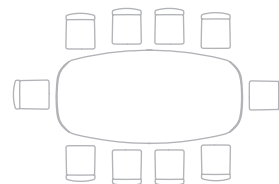

piano ovale
diamantato
diamond
oval top



240x120 H. 74
94.4"x47.2" H. 29.1"

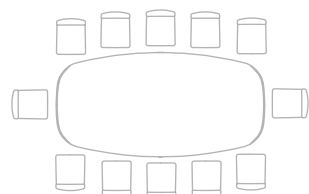

piano ovale
in ceramica
pyroceram
oval top



260x120 H. 74,8
102.3"x47.2" H. 29.4"

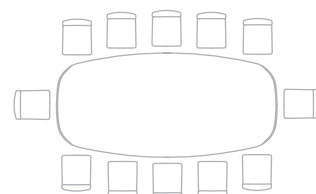

piano ovale intarsiato
inlaid oval top

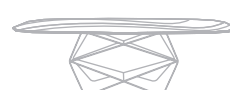

260x120 H. 77
102.3"x47.2" H. 30.3"

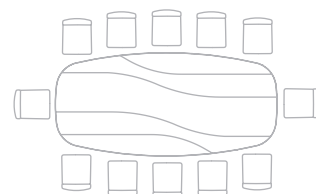

● T234 Gem
tavolo fisso - fix table
CR17 MT16

● S062 Ego BR
seduta - chair
VE01 MT16



Random

FISSO

Design
Giulio Manzoni

Un oggetto di design si staglia sullo sfondo del tuo salotto o della tua sala da pranzo. Random Fisso è il tavolo protagonista di un life style contemporaneo. Le gambe in diagonale creano un pattern geometrico che si eleva fino al top: una base leggera ed eclettica che può assumere forme e stili diversi in base al mood del tuo spazio.

A design object stands out against the background of your living room or dining room. Random Fisso is the main-character table of a contemporary lifestyle. The diagonal legs create a geometric pattern that rises up to the top: a light and eclectic base that can take on different shapes and styles based on the mood of your space.



piano in vetro - glass top



piano in legno - wooden top



piano in cemento - cement top



piano in ceramica - pyroceram top



piano intarsiato - inlaid top

● T252 Random Fisso
| tavolo fisso - fix table



T252 Random Fisso | tavolo fisso - fix table | CC11 MT12



● T252 Random Fisso
tavolo fisso - fix table
CC11 MT12

● X404 Botticelle
lampada - lamp
(8) CR14 CR20 CR22

● X312 Brera Vetro
madia - sideboard
PZ94 CR21 X17 MT98

● X028 Manga
libreria - bookcase
X17 MT97



● T252 Random Fisso
tavolo fisso - fix table
PW91

● S464 Zico
seduta - chair
B05 PW91



● T252 Random Fisso
tavolo fisso - fix table
CC11 MT12



● T252 Random Fisso
tavolo fisso - fix table
CR21 MT97



● T252 Random Fisso
tavolo fisso - fix table
CR17 MT97

● S059 Sveva
seduta - chair
P05 MT97

● X403 Atollo
lampada - lamp
PZ94

● X028 Manga
libreria - bookcase
X17 MT97

TAVOLI FISSI | Fix tables

RANDOM FISSO

piani rettangolari
rectangular top



180x90 H. 74
70.8"x35.4" H. 29.1"

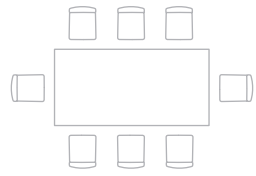

200x100 H. 74
78.7"x39.3" H. 29.1"



220x110 H. 77,5
86.6"x43.3" H. 30.5"

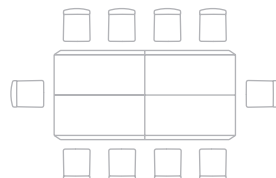

220x110 H. 77,5
86.6"x43.3" H. 30.5"



240x110 H. 74
94.4"x43.3" H. 29.1"



piano ovale
oval top



220x110 H. 74,5
86.6"x43.3" H. 29.3"



piano ovale
diamantato
diamond
oval top



240x120 H. 74
94.4"x47.2" H. 29.1"

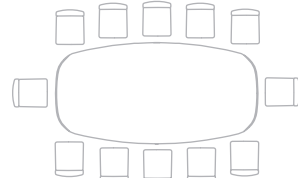

piano ovale
in ceramica
pyroceram
oval top



260x120 H. 74,5
102.3"x47.2" H. 29.3"

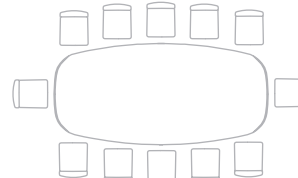

piano ovale intarsiato
inlaid oval top



260x120 H. 76,5
102.3"x47.2" H. 30.1"

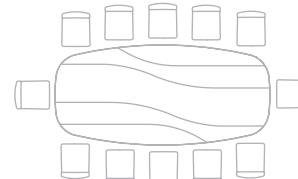

● T252 Random Fisso
tavolo fisso - fix table
CR21 MT97

Veliero • Cirkle • Big Round

FISSO FISSO FISSO

Veliero Fisso
Design
Luca Tonelli
& Davide Carlesi

Cirkle Fisso
Design
Marco Pozzoli

Big Round Fisso
Design
Studio Ozeta
& Andrea Lucatello

150 è la nuova dimensione della perfezione. Il diametro ideale per un top in ceramica dal look prestigioso che abbraccia tre tavoli della collezione OZZIO ITALIA: Cirkle Fisso, Big Round Fisso e Veliero Fisso. 4 colori da scegliere, tra cromie inedite e vibranti venature, per un progetto che ha tutto il sapore dell'esclusività.

150 is the new dimension of perfection. It is the ideal diameter for a ceramic top with a prestigious look that embraces three tables from the OZZIO ITALIA collection: Cirkle Fisso, Big Round Fisso and Veliero Fisso. 4 colors to choose among unprecedented shades and vibrant veinings, for a project with an exclusive taste.



● **T403 Veliero Fisso**
tavolo fisso - fix table
CC10 PW97

● **T402 Cirkle Fisso**
tavolo fisso - fix table
CC11 MT97

● **T401 Big Round Fisso**
tavolo fisso - fix table
CC08 MT16



T401 Big Round Fisso | tavolo fisso - fix table | CC08 MT16



● T403 Veliero Fisso
tavolo fisso - fix table
CC10 PW97

● S450 Nelson
seduta - chair
VE04

● X307 Trilogy Duo
madia - sideboard
P11 X06 MT98

● X042 Sea
specchio - mirror
VS02

TAVOLI FISSI | Fix tables

VELIERO FISSO • CIRKLE FISSO • BIG ROUND FISSO



VELIERO FISSO



150x150 H. 74
59"x59" H. 29.1"

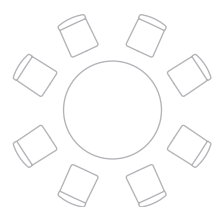

CIRKLE FISSO



150x150 H. 74,5
59"x59" H. 29.3"

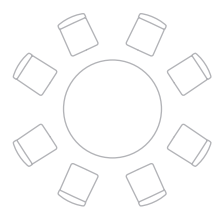

BIG ROUND FISSO



150x150 H. 75
59"x59" H. 29.5"

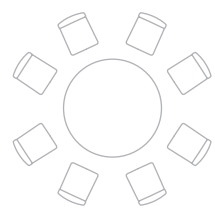

● T402 Cirkle Fisso
tavolo fisso - fix table
CC11 MT97

● S321 Blitz
seduta - chair
C25



Emisfero • Eclipse • Lycos

FISSO FISSO FISSO

Emisfero Fisso
Eclipse Fisso
Design
Studio Ozeta

Lycos Fisso
Design
Studio Ozeta
Marco Pozzoli

La semplicità della forma incontra l'eleganza delle proporzioni di questi tavoli, perfetti per i momenti di convivialità. Caratterizzati da piani dalle linee essenziali e basamenti dalle geometrie creative che disimpegnano lo spazio sotto al piano per una maggiore praticità. Sanno adattarsi ed esaltare ogni ambiente.

The simplicity of the shape meets the elegance of the proportions of these tables, perfect for moments of conviviality. Characterized by tops with essential lines and bases with creative geometries that free up the space under the top for added convenience. They know how to adapt and enhance every environment.



● T404 Emisfero Fisso
tavolo fisso - fix table
CC08 MT98



● T405 Eclipse Fisso
tavolo fisso - fix table
CC07 MT61



● T204 Lycos Fisso
tavolo fisso - fix table
CC10 MT97



T204 Lycos Fisso | tavolo fisso - fix table | CC10 MT97



● T405 Eclipse Fisso
tavolo fisso - fix table
CC07 MT61

● S022 Ego
seduta - chair
B01 MT16

● X405 Sole
lampada - lamp
X18



EMISFERO FISSO



150x150 H. 74,5
59"x59" H. 29.3"

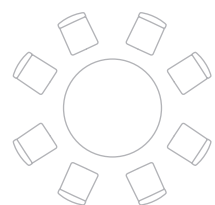

ECLIPSE FISSO



150x150 H. 74
59"x59" H. 29.1"

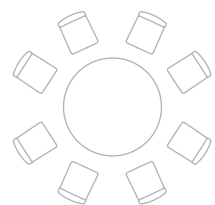

LYCOS FISSO



150x150 H. 74
59"x59" H. 29.1"

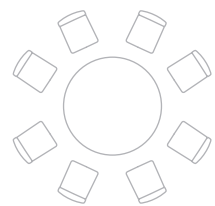

● T404 Emisfero Fisso
tavolo fisso - fix table
CC08 MT98

● S330 Viva
seduta - chair
C14

● X312 Brera Vetro
madia - sideboard
PZ94 CR21 X18 MT98



Papillon

Design
Andrea Lucatello

Il sinuoso basamento di Papillon simula il battito delle ali di una farfalla, la sua figura in legno massiccio da vita a geometrie scultoree. Il piano di questo tavolo aleggia con i suoi diversi materiali all'interno dello spazio living con eleganza e raffinatezza.

The sinuous base of Papillon simulates the wing stroke of a butterfly, its solid wood figure gives life to sculptural geometries. The top of this table floats with its different materials within the living space with elegance and refinement.



piano in vetro - glass top



piano in ceramica - pyroceram top



piano intarsiato - inlaid top

● T253 Papillon
| tavolo fisso - fix table



T253 Papillon | tavolo fisso - fix table | CR17 PW91



● T253 Papillon
tavolo fisso - fix table
CR21 PW94

● S453 Delia
seduta - chair
EP54 PW94

● X307 Trilogy Duo
madia - sideboard
P11 X17 MT97

● X037 Golden wood
specchio - mirror
X16



● T253 Papillon
tavolo fisso - fix table
PW94 PW94

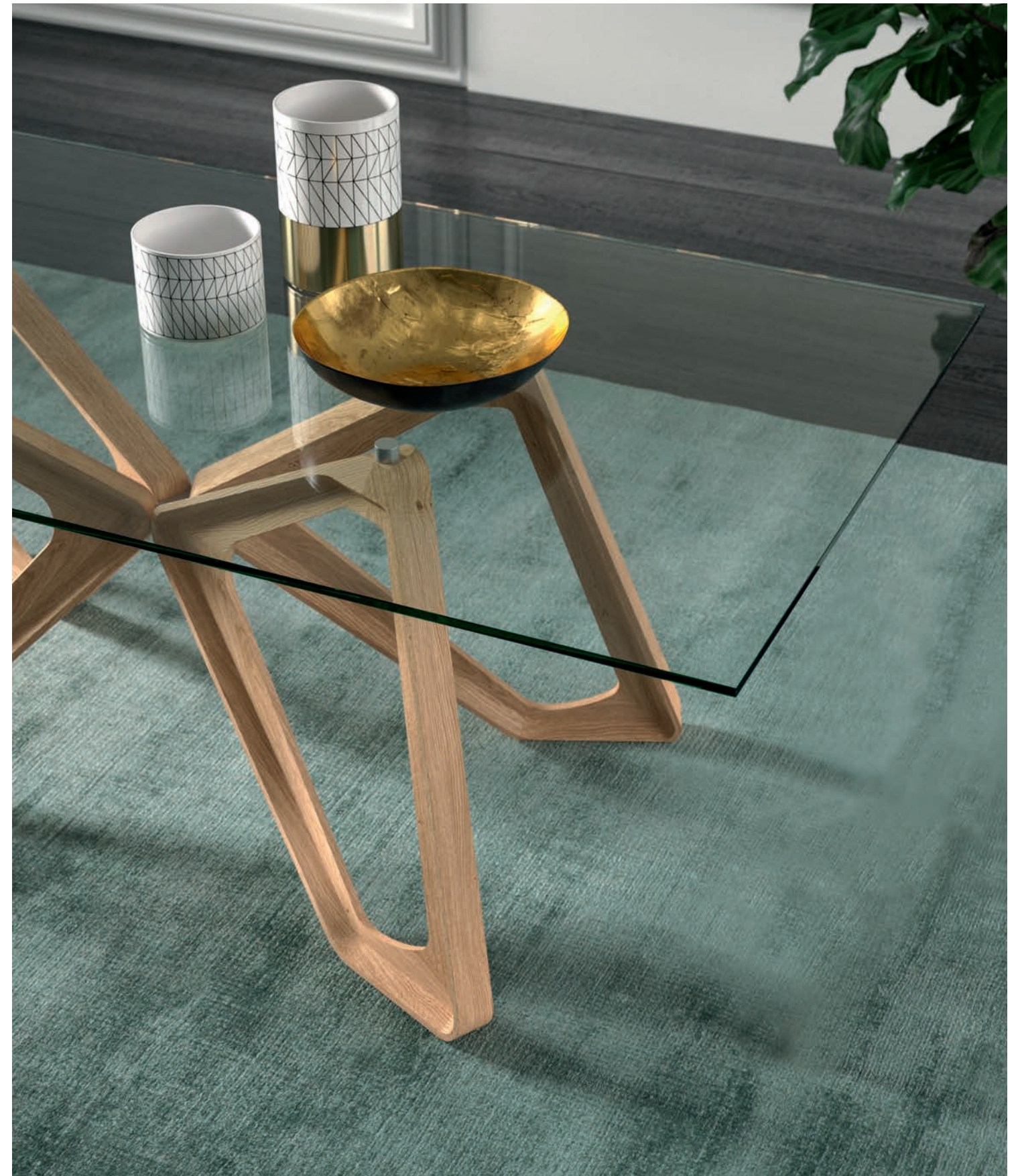

● T253 Papillon
tavolo fisso - fix table
CR17 PW91



piani rettangolari
rectangular top



180x90 H. 73,5
70.8"x35.4" H. 28.9"

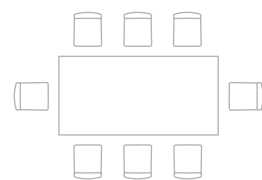

200x100 H. 73,5
78.7"x39.3" H. 28.9"



240x110 H. 73,5
94.4"x43.3" H. 28.9"



piano ovale
oval top



220x110 H. 73,5
86.6"x43.3" H. 28.9"

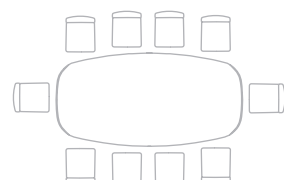

piano ovale
diamantato
diamond
oval top



240x120 H. 73,5
94.4"x47.2" H. 28.9"



piano ovale
in ceramica
pyroceram
oval top



260x120 H. 74
102.3"x47.2" H. 29.1"



piano ovale intarsiato
inlaid oval top



260x120 H. 76
102.3"x47.2" H. 29.9"



● T253 Papillon
tavolo fisso - fix table
PW94 PW94

● S453 Delia
seduta - chair
EP54 PW94



4x4 • Arizona

FISSO FISSO

Design
Giulio Manzoni

Tavoli fissi massicci e scultorei sostenuti dall'involuppo geometrico delle 4 gambe che sostengono solidamente il piano. La struttura è in legno o metallo, caratterizzata da eleganti finiture frutto di una raffinata lavorazione artigianale. Una produzione di alta qualità pensata per dare importanza agli spazi della casa contemporanea.

Massive and sculptural fixed tables supported by the geometric envelope of the 4 legs that solidly support the top. The structure is in wood or metal, characterized by elegant finishes resulting from refined craftsmanship. A high-quality production designed to give importance to the spaces of the contemporary home.



4x4 Fisso
piano in legno - wooden top



4x4 Fisso
piano intarsiato - inlaid top



4x4 Fisso
piano in cemento - cement top



Arizona Fisso
piano in legno - wooden top



Arizona Fisso
piano intarsiato - inlaid top

● T241 4x4 Fisso
| tavolo fisso - fix table

● T257 Arizona Fisso
| tavolo fisso - fix table



T241 4x4 Fisso | tavolo fisso - fix table | PZ51 MT97



● T241 4x4 Fisso
tavolo fisso - fix table
PZ51 MT97

● S316 Sofia
seduta - chair
EP14



● T241 4x4 Fisso
tavolo fisso - fix table
PZ91

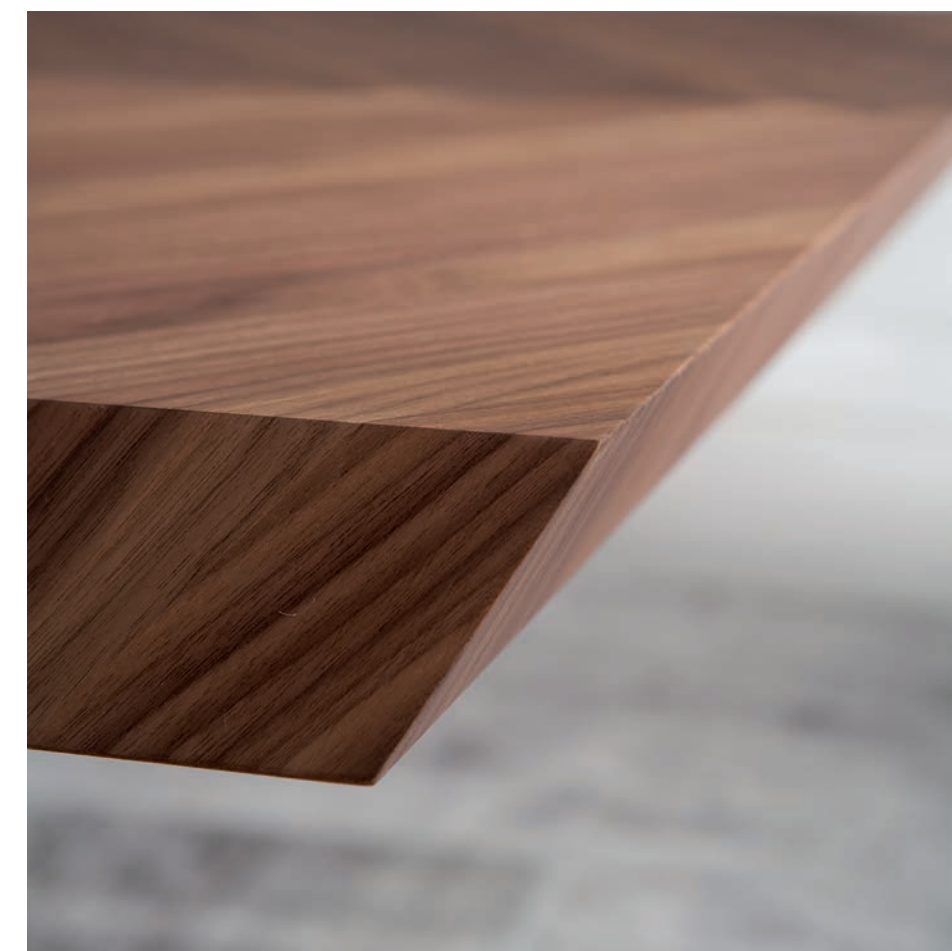

● T241 4x4 Fisso
tavolo fisso - fix table
PZ51





● T257 Arizona Fisso
tavolo fisso - fix table
PW94

● S337 Loren
seduta - chair
C31



● T257 Arizona Fisso
tavolo fisso - fix table
PW94



4x4 FISSO

piano in legno
wooden top



220x110 H. 75,5
86.6"x43.3" H. 29.7"



piano in cemento
cement top



220x110 H. 75,5
86.6"x43.3" H. 29.7"



piano ovale intarsiato
inlaid oval top



260x120 H. 74
102.3"x47.2" H. 29.1"

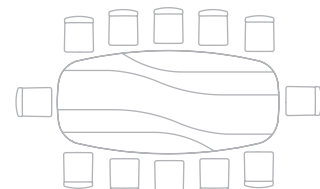

ARIZONA FISSO

piano in legno
wooden top



220x110 H. 76
86.6"x43.3" H. 29.9"

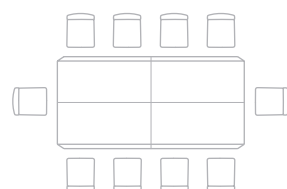

piano ovale intarsiato
inlaid oval top



260x120 H. 73,5
102.3"x47.2" H. 28.9"

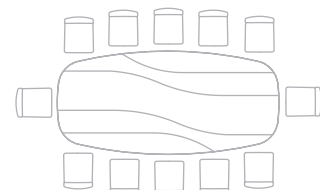

● T241 4x4 Fisso
tavolo fisso - fix table
CM98 MT98

● S322 Lunette
seduta - chair
P20

● X040 Monza
specchio - mirror
PZ94



FIL8

FISSO

Design
Giulio Manzoni

Un tavolo best seller che non bisogno di presentazioni. La leggerezza e gli intrecci della base in filo metallico, catturano lo sguardo e ci indirizzano verso il sottile ma prezioso ripiano, disponibile in legno, cemento, Marble Glass e ceramica. Tanto eclettico quanto raffinato, regala scorci sempre diversi a seconda del punto di vista.

A best-selling table that doesn't need any introduction. The lightness and interweaving of the metal wire base catch the eye and direct us towards the thin but precious shelf, available in wood, concrete, Marble Glass and ceramic. As eclectic as refined, it always offers different glimpses depending on the point of view.



piano in Marble Glass - Marble Glass top



piano in legno - wooden top



piano in cemento - cement top



piano in ceramica - pyroceram top



piano intarsiato - inlaid top

● T237 FIL8 Fisso
| tavolo fisso - fix table



T237 FIL8 Fisso | tavolo fisso - fix table | CC07 MT12



● T237 FIL8 Fisso
tavolo fisso - fix table
PZ51

● S053 Olimpia
seduta - chair
P11



● T237 FIL8 Fisso
tavolo fisso - fix table
PZ51 MT98





piani rettangolari
rectangular top



180x90 H. 74
70.8"x35.4" H. 29.1"

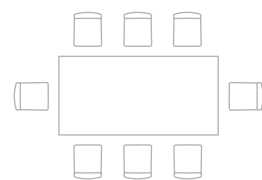

200x100 H. 74
78.7"x39.3" H. 29.1"



220x110 H. 75,5
86.6"x43.3" H. 29.7"



220x110 H. 75,5
86.6"x43.3" H. 29.7"



piano ovale
oval top



220x110 H. 74
86.6"x43.3" H. 29.1"

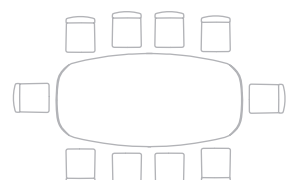

piano ovale
in ceramica
pyroceram
oval top



260x120 H. 74
102.3"x47.2" H. 29.1"

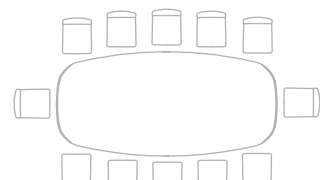

piano ovale intarsiato
inlaid oval top



260x120 H. 75
102.3"x47.2" H. 29.5"



● T237 FIL8 Fisso
tavolo fisso - fix table
CC07 MT12

● S346 Frisbee BR
seduta - chair
C18

● X404 Botticelle
lampada - lamp
(6-B) CR14 CR20



Madie

Sideboards

Sarah

Design
Luca Roccadadria

La superficie delle ante in specchio curvato evoca l'incanto del dolce movimento di una superficie d'acqua in un continuo fluire di giochi di luce. Sarah è la madia che riempie lo spazio con suggestive geometrie, sfumate e ondulate, ricche di infiniti riflessi. Silenzio. Non resta che immergersi nello spettacolo.

The curved mirror surface of the doors evokes the enchantment of the gentle movement of a water surface in a continuous flow of light effects. Sarah is the sideboard that fills the space with suggestive, shaded and wavy geometries, full of infinite reflections. Silence. All that remains is to immerse yourself in this show.



● X313 Sarah
madia - sideboard
VS02 X06 CR14



X313 Sarah | madia - sideboard | VS02 X06 CR14



● X313 Sarah
madia - sideboard
VS01 X17 CR14

● X042 Sea
specchio - mirror
VS01

● X016 Panto angolare
libreria - bookcase
PW97 CR14 MT97

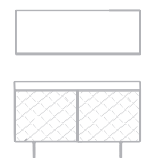

148,5x50 H. 72 (piedi H. 10)
58.4"x19.6" H. 28.3" (feet H. 3.9")

148,5x50 H. 82 (piedi H. 20)
58.4"x19.6" H. 32.2" (feet H. 7.8")

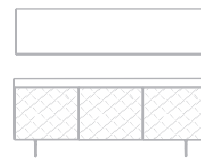

222,8x50 H. 72 (piedi H. 10)
87.7"x19.6" H. 28.3" (feet H. 3.9")

222,8x50 H. 82 (piedi H. 20)
87.7"x19.6" H. 32.2" (feet H. 7.8")

● X313 Sarah
| madia - sideboard
| VS01 X17 CR14



Giulia

Design
Luca Roccadadria

Specchio delle mie brame qual è la madia più cool del reame? Giulia conquista lo sguardo con la sua lucida trama d'argento che supera la barriera del tempo in uno splendido ritorno al futuro. Il lusso di una madia audace, spigolosa, che brilla di personalità. Ideale per chi ama stupire.

Mirror, mirror on the wall, which is the coolest sideboard of them all? Giulia draws the attention thanks to its shiny silver or bronze texture that overcomes the barrier of time in a splendid return to the future. The luxury of a bold, angular sideboard that shines with personality. Ideal for those who love to amaze.

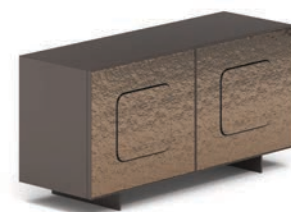

● X311 Giulia
madia - sideboard
VB01 X17 MT97



X311 Giulia | madia - sideboard | VB01 X17 MT97



● X311 Giulia
madia - sideboard
VB01 X17 MT97



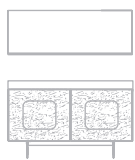

148,5x50 H. 72 (piedi H. 10)
58.4"x19.6" H. 28.3" (feet H. 3.9")

148,5x50 H. 82 (piedi H. 20)
58.4"x19.6" H. 32.2" (feet H. 7.8")

● X311 Giulia
madia - sideboard
VB02 X06 MT98

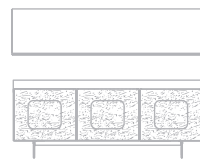

222,8x50 H. 72 (piedi H. 10)
87.7"x19.6" H. 28.3" (feet H. 3.9")

222,8x50 H. 82 (piedi H. 20)
87.7"x19.6" H. 32.2" (feet H. 7.8")

● X041 Raggio
specchio - mirror
VB02



Rain Rain Wood

Design
Studio Ozeta
& Luca Roccadadria

Un'elegante cascata di listelli in legno scende dalle ante a specchio, dando vita a una sorprendente danza di riflessi, profondità e contrasti. Rain è un complemento ispirato alla natura che assume le sembianze dell'ambiente circostante. Disponibile anche nella versione wood, per chi allo specchio preferisce il calore del legno.

An elegant cascade of wooden slats descends from the mirrored doors, creating a surprising dance of reflections, depths and contrasts. Rain is a complement inspired by nature that takes on the appearance of the surrounding environment. Available in the wood version too, for those who prefer the warmth of wood instead of a mirror.

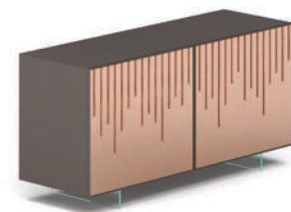

X314 Rain
VS01 PZ51 X17 CR14

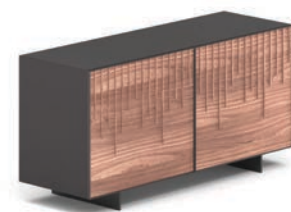
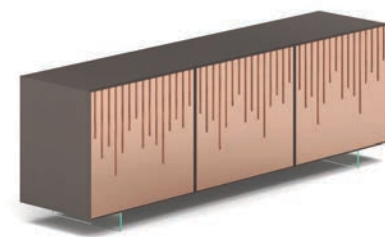

X315 Rain Wood
PZ51 X06 MT98

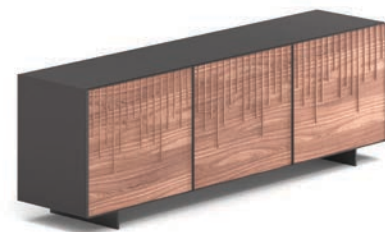

X314 Rain | madia - sideboard | VS01 PZ51 X17 CR14



● X314 Rain
madia - sideboard
VS01 PZ51 X17 MT97

● T252 Random Fisso
tavolo fisso - fix table
CR17 MT97

● S059 Sveva
seduta - chair
P05 MT97

● X403 Atollo
lampada - lamp
PZ94

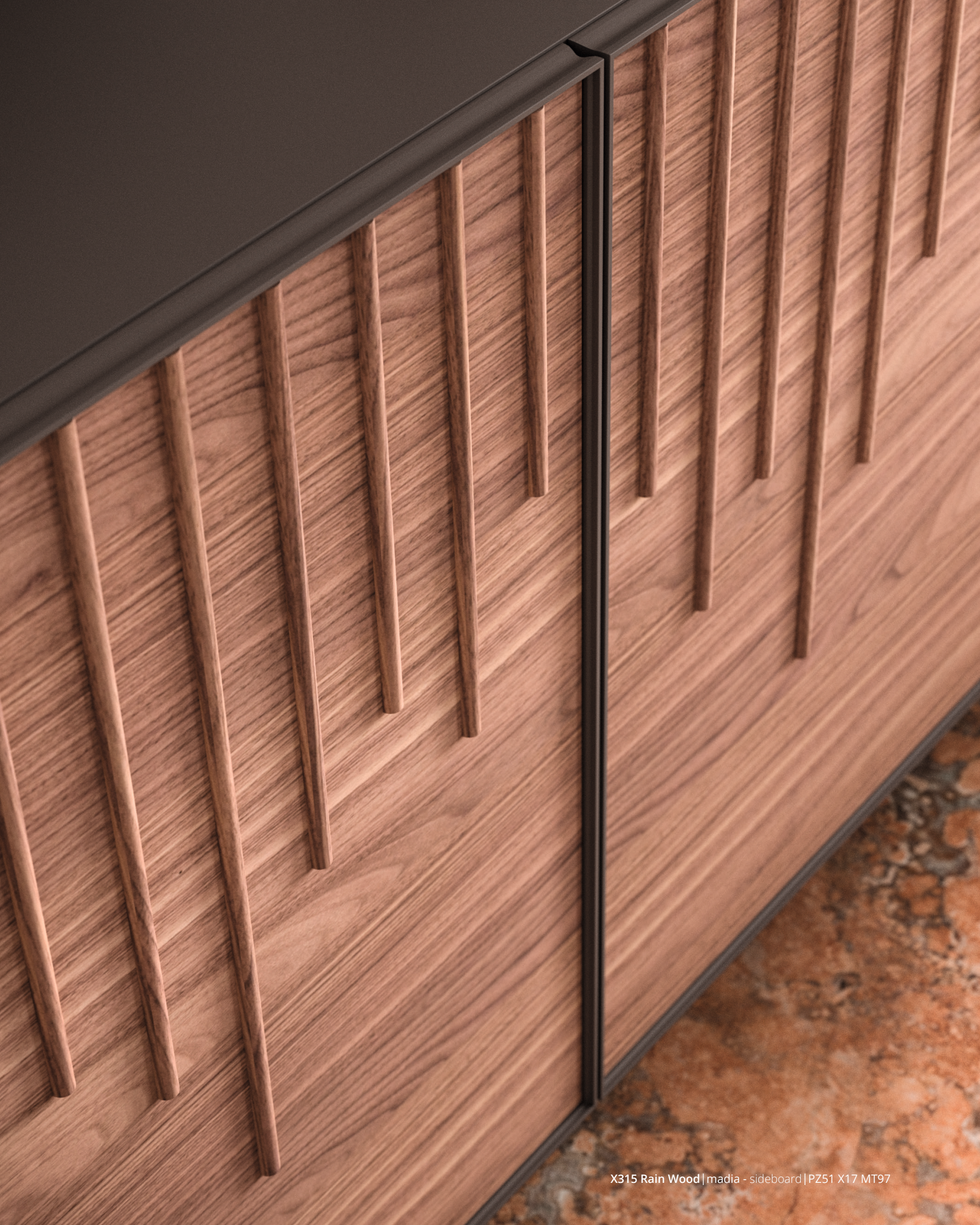

X315 Rain Wood | madia - sideboard | PZ51 X17 MT97

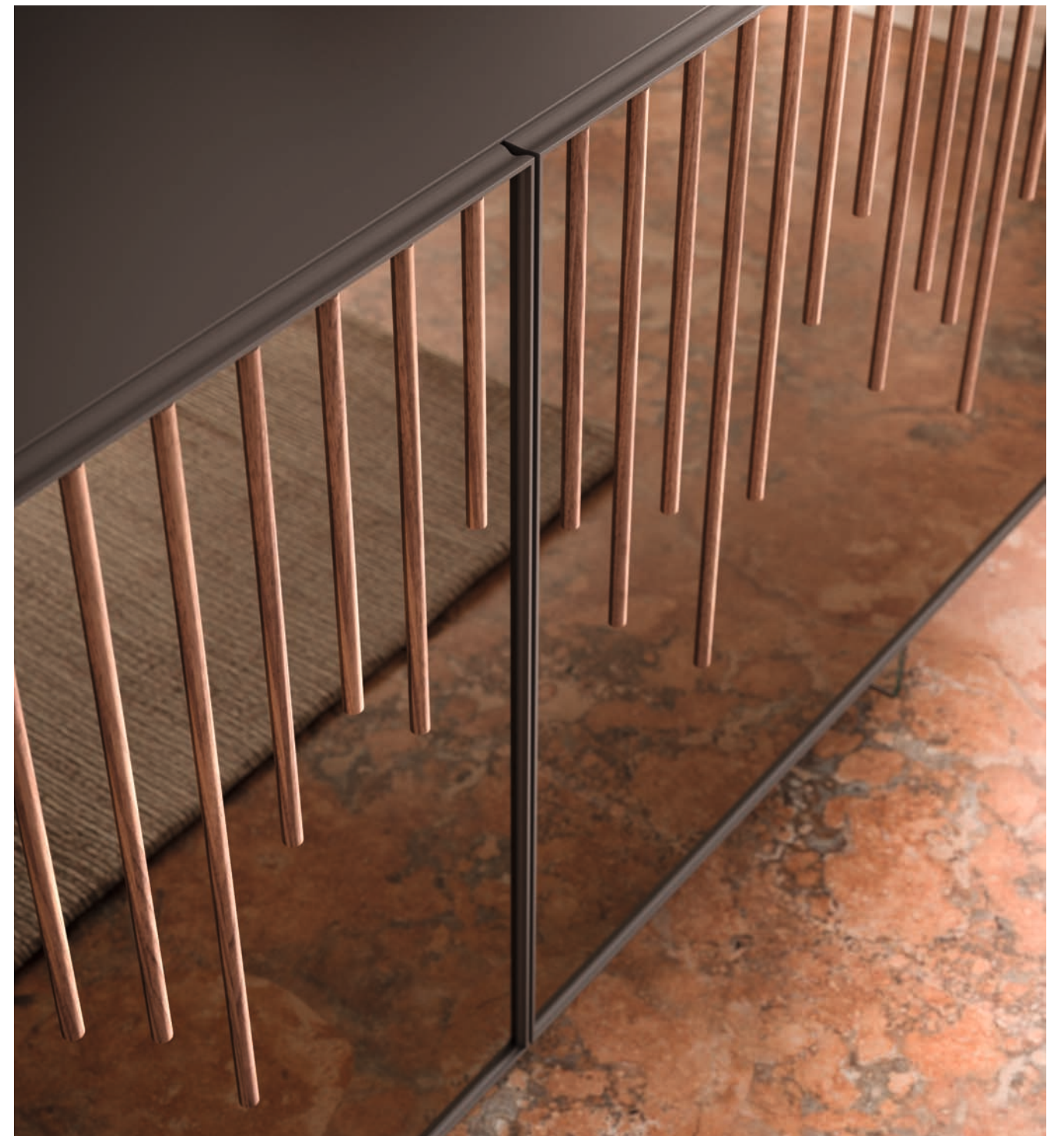

● X314 Rain
| madia - sideboard
| VS01 PZ51 X17 CR14

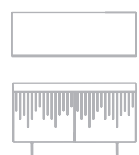

148,5x50 H. 72 (piedi H. 10)
58.4"x19.6" H. 28.3" (feet H. 3.9")

148,5x50 H. 82 (piedi H. 20)
58.4"x19.6" H. 32.2" (feet H. 7.8")

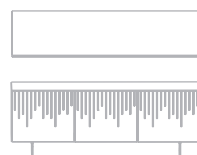

222,8x50 H. 72 (piedi H. 10)
87.7"x19.6" H. 28.3" (feet H. 3.9")

222,8x50 H. 82 (piedi H. 20)
87.7"x19.6" H. 32.2" (feet H. 7.8")

● X315 Rain Wood
madia - sideboard
PZ51 X06 MT98



Grace

Design
Marco Pozzoli

La grazia si eleva al cubo, incorniciata da un telaio in alluminio. Grace è un'idea che prende forma, quasi sospesa nello spazio, grazie alla leggerezza dei piedini di sostegno. Le ante rivestite in cuoio donano eleganza all'ambiente proteggendo lo scrigno dei tuoi desideri. Basta un tocco e scorrono: si apre il sipario.

Grace cubes, framed by an aluminum frame. Grace is an idea that takes shape, almost suspended in space, thanks to the lightness of its support legs. The doors covered in leather give elegance to the environment protecting the casket of your desires. Just a touch and they scroll: the curtain opens.



● X310 Grace
| madia - sideboard
| C14 X17 CR14

X310 Grace | madia - sideboard | C18 X06 MT98





● X310 Grace
| madia - sideboard
| C14 X17 CR14



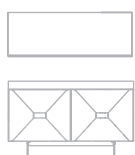

148,5x50 H. 72 (piedi H. 10)
58.4"x19.6" H. 28.3" (feet H. 3.9")

148,5x50 H. 82 (piedi H. 20)
58.4"x19.6" H. 32.2" (feet H. 7.8")



222,8x50 H. 72 (piedi H. 10)
87.7"x19.6" H. 28.3" (feet H. 3.9")

222,8x50 H. 82 (piedi H. 20)
87.7"x19.6" H. 32.2" (feet H. 7.8")

● **X310** Grace
madia - sideboard
C14 X17 CR14

● **T402** Cirkle Fisso
tavolo fisso - fix table
CC11 MT97

● **S321** Blitz
seduta - chair
C25

Trilogy Duo

Design
Andrea Lucatello

I design assoluti sono destinati a durare per sempre. Le geometrie del passato ritornano e quando il design incontra lo stile il risultato è Trilogy Duo. Madia contenitore con ante in pelle battenti ed ampi vani con ripiani in cristallo.

Absolute designs are designed to last forever. The geometries of the past return and when design meets style, the result is Trilogy Duo. Container sideboard with leather hinged doors and large compartments with glass shelves.



● X307 Trilogy Duo
madia - sideboard
P11 X17 MT97





● X307 Trilogy Duo
 madia - sideboard
 P04 X17 CR14



● X037 Golden Wood
 specchio - mirror
 X16



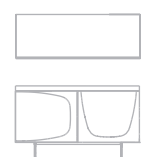

148,5x50 H. 72 (piedi H. 10)
58.4"x19.6" H. 28.3" (feet H. 3.9")

148,5x50 H. 82 (piedi H. 20)
58.4"x19.6" H. 32.2" (feet H. 7.8")



222,8x50 H. 72 (piedi H. 10)
87.7"x19.6" H. 28.3" (feet H. 3.9")

222,8x50 H. 82 (piedi H. 20)
87.7"x19.6" H. 32.2" (feet H. 7.8")

● X307 Trilogy Duo
madia - sideboard
P90 X17 CR14



Brera Brera Vetro

Design
Massimiliano Mornati

Stile classico e struttura leggera ma capiente dotata di mensole in cristallo. Disponibile in due versioni: la prima semplice e simmetrica e la seconda resa familiare e accogliente dalle ante in vetro attraverso le quali si possono intravedere i ripiani retro-illuminati. Due madie la cui qualità è capace di impreziosire l'ambiente circostante.

Classic style and light but capacious structure equipped with glass shelves. Available in two versions: the first one is simple and symmetrical while the second one is made informal and cozy by the glass doors through which the backlit shelves can be glimpsed. Two sideboards whose quality can embellish the surrounding environment.



X302 Brera
PZ51 X06 MT98



X312 Brera Vetro
PZ94 CR21 X18 MT98

X312 Brera Vetro | madia - sideboard | X18 CR21 X17 MT98





● X312 Brera Vetro
madia - sideboard
PZ94 CR21 X17 MT98

● X400 Astrum
lampada arco - arc lamp
PZ94 MT97



● X302 Brera
madia - sideboard
PZ91 X03 MT98



MADIE | Sideboards

BRERA • BRERA VETRO



BRERA



155x54,5 H. 75
61"x21.4" H. 29.5"



205x54,5 H. 75
80.7"x21.4" H. 29.5"

BRERA VETRO



205x54,5 H. 75
80.7"x21.4" H. 29.5"

● X302 Brera
| madia - sideboard
| PZ51 X06 MT98



Brera TV

Design
Massimiliano Mornati

Elegante madia contenitore oppure mobile tv? Brera TV è la risposta ad entrambe le esigenze. Rigorosa nel design ed essenziale nei volumi questa madia dispone di contenitore oltre ad essere un comodo porta tv.

Elegant container sideboard or TV cabinet? Brera TV is the answer to both needs. Rigorous in its design and essential in its volumes, this sideboard has a storage as well as being a comfortable TV stand.



● X309 Brera TV
madia - sideboard
PZ94 CR21 X06 MT98



X309 Brera TV | madia - sideboard | PZ51 CR21 X03 MT98



● X309 Brera TV
 | madia - sideboard
 | PW96 CR21 X06 MT98



● X309 Brera TV
 | madia - sideboard
 | PW94 CR21 X17 MT98





224x54,5 H. 57
88.1"x21.4" H. 22.4"

● X309 Brera TV
madia - sideboards
PZ94 CR21 X06 MT98

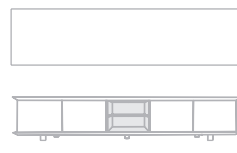

224x54,5 H. 44,5
88.1"x21.4" H. 17.5"

● X038 Miami Vice
specchio - mirror
MG05 MG02



Armor

Design
Studio Ozeta

La madia a tre o quattro ante Armor, completa la gamma di categoria della collezione OZZIO ITALIA grazie al suo completo rivestimento in ceramica. Finitura interna opaca, ripiani in cristallo trasparente e piedini minimal donano a questo complemento un valore aggiunto nella sua collocazione all'interno del living contemporaneo.

The three or four door Armor sideboard completes the category range of the OZZIO ITALIA collection thanks to its complete ceramic coating. Matt internal finish, transparent glass shelves and minimal leg give this accessory added value in its location within your contemporary living room.



● X306 Armor
madia - sideboard
CC11 MT98



X306 Armor | madia - sideboard | CC10 MT98



● X306 Armor
| madia - sideboard
| CC07 MT98

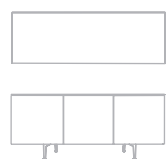

162x55,5 H. 72
63.7"x21.8" H. 28.3"

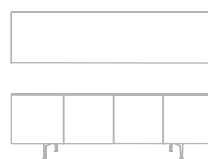

215x55,5 H. 72
84.6"x21.8" H. 28.3"

● X306 Armor
madia
sideboard
CC11 MT98

● X042 Sea
specchio
mirror
VS02

● X505 Kony
tavolino
coffee table
PW61 CC11 MT16

● X401 Discovery
lampada da terra
floor lamp
PZ94 MT97



Plana

Design
Studio Ozeta

Madia con ante complanari nella preziosa finitura Marble Glass, massimizza gli spazi con lo scorrimento sovrapposto delle ante. Vani contenitivi dotati di mensole in cristallo. Ideale per essere abbinata ai tavoli 4x4, FIL8 e Random nella stessa finitura.

Sideboard with coplanar doors in the precious Marble Glass finish, maximizes space by sliding overlapping doors. Storage equipped with glass shelves. Ideal to be combined with 4x4, FIL8 and Random tables in the same finish.



● X308 Plana
madia - sideboard
MG03 MT98



X308 Plana | madia - sideboard | MG02 MT98



● X308 Plana
madia - sideboard
MG05 MT98

● X038 Miami Vice
specchio - mirror
MG02



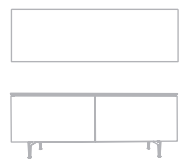

181,5x55 H. 74
71.4"x21.6" H. 29.1"

● X308 Plana
madia - sideboard
MG03 MT98



Ego Ego BR

Design
Davide Carlesi
Luca Tonelli

Leggerezza visiva e sofisticata raffinatezza. Ego è una seduta di design progettata per renderti protagonista. Qui, ogni dettaglio incarna la promessa di massimo comfort unito a un'eleganza senza tempo. Nella versione con braccioli, lo schienale si estende in un abbraccio avvolgente. Una sedia che racconta una storia, la tua.

Visual lightness and sophisticated refinement. Ego is a design seat designed to make you the main character. Here, every detail embodies the promise of maximum comfort combined with timeless elegance. In the version with armrests, the backrest extends in an enveloping embrace. A chair that tells a story, yours.



● S022 Ego
seduta - chair
B01 MT16



● S062 Ego BR
seduta - chair
B01 MT16



S062 Ego BR | seduta - chair | B02 MT98



● S062 Ego BR
seduta - chair
VE03 MT97

● S022 Ego
seduta - chair
VE01 MT16

● S062 Ego BR
seduta - chair
EP14 MT98

● S022 Ego
seduta - chair
B01 MT16



EGO

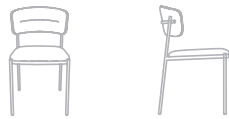

48,9x53,2 H. 81,5
19.2"x20.9" H. 32"

EGO BR



53x53,2 H. 81,5
20.8"x20.9" H. 32"

● S022 Ego
seduta
chair
EP14 MT98

● S062 Ego BR
seduta
chair
EP14 MT98

● T404 Emisfero Fisso
tavolo fisso
fix table
CC08 MT98



Juliette

Design
Marco Pozzoli

Gambe affusolate si ergono leggiadre verso una morbida seduta che ha tutta l'aria di un comfort totale. Juliette ha uno schienale bombato, delicatamente arcuato che declina sul sedile quasi abbracciandolo. Forme senza tempo e profilo sottile di una seduta essenziale. Un tocco di classe per il tuo living.

Tapered legs rise gracefully towards a soft seat that looks like a total comfort. Juliette has a rounded, gently arched backrest that declines on the seat almost embracing it. Timeless shapes and slim profile of an essential seat. A touch of class for your living room.



● S013 Juliette
seduta - chair
B02 MT97



S013 Juliette | seduta - chair | EP15 MT98



● S013 Juliette
seduta - chair
B02 MT97



49x60 H. 87
19.2"x23.6" H. 34.2"

● S013 Juliette
seduta - chair
B02 MT97

● T252 Random Fisso
tavolo fisso - fix table
CC11 MT97

Zico

Design
Studio Ozeta

Sintesi tra qualità e morbidezza, Zico è una confortevole poltroncina dalla struttura leggera in legno alla quale si congiunge una seduta imbottita ideale per il relax. La sua forma ci invita e avvolge ed è una naturale risposta funzionale alle esigenze dell'abitare.

A synthesis between quality and softness, Zico is a comfortable armchair with a light wooden structure which is connected to a padded seat, perfect for you to relax. Its shape invites and envelops us and it is a natural functional response to the needs of your living.



● S464 Zico
seduta - chair
B05 PW97



S464 Zico | seduta - chair | B03 PW96



● S464 Zico
seduta - chair
B05 PW97



56,3x59,6 H. 80,3
22.1"x23.4" H. 31.6"

● S464 Zico
seduta - chair
EP13 PW94

● T252 Random Fisso
tavolo fisso - fix table
CR21 MT97



Megan

Design
Studio Ozeta

Megan si fa spazio nell'ambiente domestico con le sue curve delicate. Un morbido rivestimento imbottito sembra posarsi delicatamente sullo schienale, ricadendo poi sul dorso, per aumentare il comfort della seduta. Contenuta nelle proporzioni ed essenziale nell'eleganza, risulta l'abbinamento ottimale per la zona living.

Megan makes room in the home environment with her delicate curves. A soft padded covering seems to rest delicately on the backrest, then falling over the back, to increase the comfort of the seat. Restrained in proportions and essential in elegance, it is the perfect combination for your living area.



● S314 Megan
seduta - chair
P04



S314 Megan | seduta - chair | P04



● S314 Megan
seduta - chair
P04



SEDUTE | Chairs

MEGAN

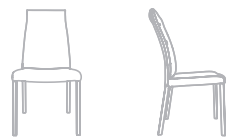

47,1x57,6 H. 93
18.5"x22.6" H. 36.6"

● S314 Megan
seduta - chair
P20

● T315 Eclipse Legno
tavolo allungabile - extendable table
PW96 MT97

Blitz

Design
Studio Ozeta

Lo schienale sinuoso della sedia Blitz segue ergonomicamente la postura del tratto dorso-lombare per un comfort superiore. Disponibile in molteplici colori e materiali che la rivestono interamente. Le gambe posteriori si presentano leggermente inclinate per migliorarne la stabilità.

The sinuous back of the Blitz chair ergonomically follows the posture of the dorso-lumbar section for superior comfort. Available in multiple colors and materials that completely cover it. The rear legs are slightly inclined to improve stability.



● S321 Blitz
seduta - chair
P19



● S321 Blitz
seduta - chair
C25



● S321 Blitz
seduta - chair
VE05



S321 Blitz | seduta - chair | P19



● S321 Blitz
seduta - chair
C30



● S321 Blitz
seduta - chair
EP51

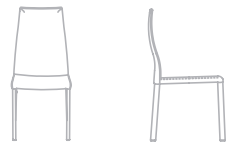

46x54 H. 96
18.1"x21.2" H. 37.7"

● S321 Blitz
seduta - chair
VE07 - P19 - C18



Baia Baia BR

Design
Andrea Lucatello

Linee e curve sinuose dialogano tra loro dando vita a un'elegante forma a guscio, sorretta da una struttura in massello di frassino. Baia è un nido accogliente in cui godere della piacevole sensazione di essere avvolti in un rassicurante abbraccio. Disponibile anche nella versione con braccioli, per un effetto cocoon ancora più accentuato.

Sinuous lines and curves interact with each other, creating an elegant shell shape, supported by a solid ash structure. Baia is a welcoming nest perfect to enjoy the pleasant sensation of being wrapped in a reassuring hug. Also available in armrests version, for an even more accentuated cocoon effect.



● S012 Baia
seduta - chair
B03 PW94



● S463 Baia BR
seduta - chair
B03 PW94

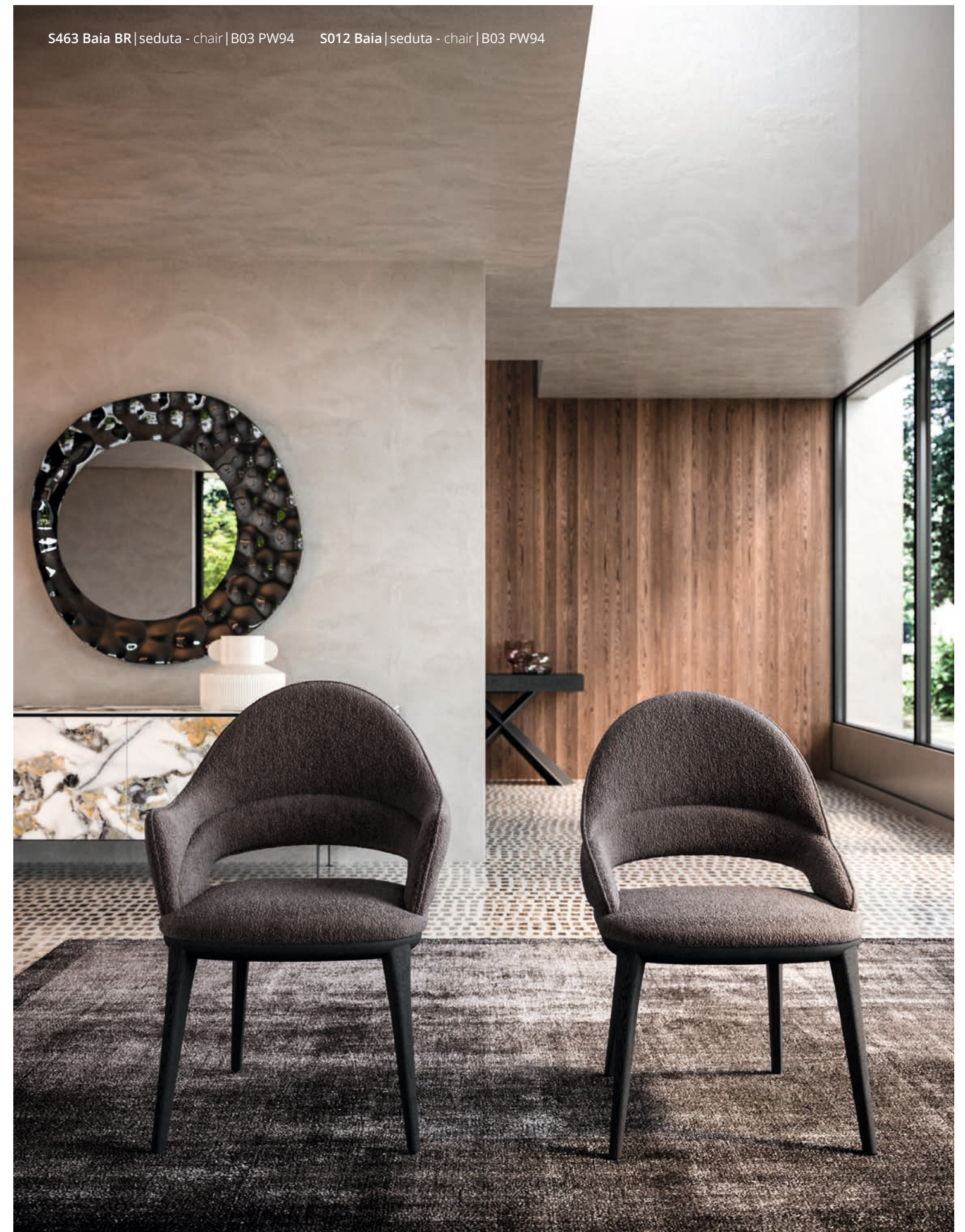

S463 Baia BR | seduta - chair | B03 PW94 S012 Baia | seduta - chair | B03 PW94



● S463 Baia BR
seduta - chair
B01 PW91

● S012 Baia
seduta - chair
B01 PW91





BAIA

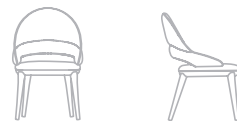

56,4x64 H. 88
22.2"x25.1" H. 34.6"

BAIA BR



62,3x64 H. 88
24.5"x25.1" H. 34.6"

● S012 Baia
seduta - chair
VE03 PW96

● S463 Baia BR
seduta - chair
P90 PW97

● X306 Armor
madia - sideboard
CC11 MT98

● X402 Sea
specchio - mirror
VS02



Cubix

Design
Giulio Manzoni

Sorprendente, trasformabile, indispensabile, sono solo alcuni degli aggettivi che descrivono al meglio questo innovativo complemento. L'avveniristico studio di intersezioni cela all'interno cinque sedute, quattro delle quali progettate per essere utilizzate come comode sedie dotate di poggia schiena imbottito. Articolo insostituibile per la praticità di utilizzo, dotato di quattro ruote per una facile movimentazione oltre che a elegante progetto di doppia cucitura per semplificare il riposizionamento in sede delle sedute.

Surprising, transformable, essential, are just some of the adjectives that best describe this innovative item. The futuristic study of intersections hides five chairs inside, four of which are comfortable chairs with upholstered backrests. A unique item easy to use, equipped with four sliding wheels for easy handling, and an elegant double stitching design to simplify the opening and closing system.



● S011 Cubix
pouf trasformabile - transformable pouf
EP90 MT97





● S011 Cubix
pouf trasformabile - transformable pouf
EP90 MT97



La trasformabilità di Cubix

Cubix transformability

01.



Pouf trasformabile dotato di rotelle per una facile movimentazione. Utilizzabile come seduta anche completamente "chiuso". L'elegante doppia cucitura semplifica il riposizionamento in sede delle quattro sedute interne.

Transformable pouf equipped with castors for easy handling. It can be used as a sitting when completely "closed". The elegant double stitching simplifies the repositioning of the four internal seats.

02.



L'estrazione delle sedute è pratica e intuitiva. È possibile utilizzare il numero di sedute desiderato, lasciando all'interno del pouf quelle che non risultano necessarie.

The extraction of the sittings is practical and intuitive. It is possible to use the number of sittings needed and leave the other ones stored inside the pouf.

03.



Le quattro sedute interne, una volta estratte, possono essere utilizzate anche senza l'ausilio dello schienale, ma come semplici sgabelli.

The four internal sittings, once extracted, can also be used without the backrest but as simple stools.

04.



Per un maggiore confort e completa libertà di utilizzo, le quattro sedute interne sono dotate di un morbido schienale imbottito. Mentre il pouf con rotelle può essere utilizzato anch'esso come seduta o come tavolino da appoggio.

For greater comfort and complete freedom of use, the four internal sittings are equipped with a padded backrest. While the pouf with castors can also be used as a stool or as a coffee table.



S011 Cubix | pouf trasformabile - transformable pouf | B01 VE01 EP54 MT97



● S011 Cubix
pouf trasformabile - transformable pouf
B02 VE04 MT97



57x57 H. 53
22.4"x22.4" H. 20.9"

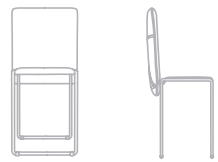

42x46 H. 82
16.5"x18" H. 32.3"

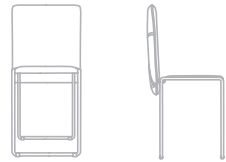

42,5x51 H. 83
16.7"x20.5" H. 32.7"

● S011 Cubix
pouf trasformabile
transformable pouf
EP90 MT97

● T110 Box
tavolino trasformabile
transformable table
MG05 MT97

Giotto

Design
Andrea Lucatello

Dall'armonico incontro tra legno e pelle prende forma una seduta che mette a nudo i suoi elementi essenziali. Il rivestimento sapientemente lavorato, evidenzia le cuciture sartoriali e l'impuntura che esalta lo schienale concepito ergonomicamente per fornire il massimo comfort. La struttura in massello plasma giochi di pieni e vuoti mediante configurazioni inflessibili e curvilinee.

From the harmonious match between wood and leather, a chair takes form and reveals its essential elements. The skillfully handmade cover highlights the tailored stitching that enhances the ergonomically designed backrest to provide the maximum comfort. The solid wood structure shapes design of inflexible and curvilinear configurations.



● S010 Giotto
seduta - chair
B02 PW96



S010 Giotto | seduta - chair | P90 PW97 - P90 PW91



S010 Giotto | seduta - chair | P19 PW61 - P90 PW97 - P90 PW91



● S010 Giotto
| seduta - chair
| B05 PW94

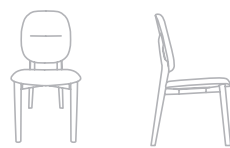

48x57 H. 91
18.8"x22.4" H. 35.8"

● S010 Giotto
seduta - chair
B02 PW96

● T202 Lycos
tavolo allungabile - extendable table
MG05 CM62



Frisbee Frisbee BR

Design
Marco Pozzoli
Studio Ozeta

L'abito in total leather riveste perfettamente le geometrie squadrate dell'innovazione. In Frisbee, funzionalità e design contemporaneo si uniscono con armonia in una seduta che guarda al futuro. Look esclusivo e tutto il carattere che serve ai tuoi ambienti, con o senza braccioli.

The total leather dress perfectly covers the square geometries of innovation. In Frisbee, functionality and contemporary design come together harmoniously in a seat that looks into the future. It has an exclusive look and all the personality your environments need, with or without armrests.



● S341 Frisbee
seduta - chair
C25



● S346 Frisbee BR
seduta - chair
C25





● S346 Frisbee BR
seduta - chair
C18



● S341 Frisbee
seduta - chair
C25





FRISBEE



48,3x53,3 H. 84,5
19"x20.9" H. 33.2"

FRISBEE BR

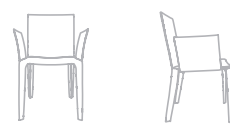

57,7x53,3 H. 84,5
22.7"x20.9" H. 33,2"

● S341 Frisbee
seduta - chair
C14

● S346 Frisbee BR
seduta - chair
C14

● T237 Fil8 Fisso
tavolo fisso - fix table
PZ51 MT98



Kite

Design
Andrea Lucatello

La seduta Kite si libra sinuosa
nella vostra casa. Le pronunciate
forme geometriche del cuoio
ne conferiscono un aspetto unico
a ricordare il disegno di un aquilone.

The Kite chair sinuously hovers
in your home. The pronounced
geometries of the leather give it
a shape of wings to form the design
of a kite.



● S336 Kite
seduta - chair
C32



S336 Kite | seduta - chair | C31 - C32



● S336 Kite
seduta - chair
C30 - C09 - C10 - C31



52,5x57 H. 90
20,6"x22,4" H. 35,4"

● S336 Kite
seduta - chair
C30

● T234 Gem
tavolo fisso - fix table
CR17 MT16 & MT97



Loren

Design
Studio Ozeta

Avvolgente come un caldo abbraccio ed al tempo stesso rigorosa come il cuoio. Loren è una sedia in cuoio rigido che rimane perfettamente ordinata come la vorreste ritrovare al vostro ritorno a casa.

Enveloping as a warm embrace and at the same time as rigorous as leather. Loren is a rigid leather chair that remains perfectly tidy as you would like it to be when you return home.



● S337 Loren
seduta - chair
C18



S337 Loren | seduta - chair | C10 - C31 - C18



● S337 Loren
seduta - chair
C31



48,5x54 H. 86,5
19"x21.2" H. 34"

● S337 Loren
seduta - chair
C11

Viva

Design
Toshiyuki Yoshino
Studio Ozeta

Viva è una seduta armonica e rigorosa. Lo schienale è formato da una curva che rientra dolcemente ad accompagnare la seduta verso il basso, qui entra timidamente in contatto con la seduta nelle due estremità laterali. Il rivestimento monometrico ne esalta l'eleganza e le consente di conservare il suo valore nel tempo.

Viva is a harmonious and rigorous seat. The backrest is formed by a curve that gently falls in order to accompany the seat downwards, here it timidly comes into contact with the seat at the two lateral ends. The monometric coating enhances its elegance and allows it to maintain its value over time.



● S330 Viva
seduta - chair
C25



S330 Viva | seduta - chair | C14



● S330 Viva
seduta - chair
C14



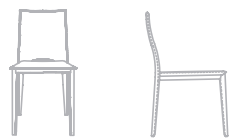

45x48 H. 86
17.7"x18.8" H. 33.8"

● S330 Viva
seduta - chair
C10 - C09 - C30 - C32



Betta

Design
Studio Ozeta

Una seduta che si contraddistingue per l'attenta lavorazione artigianale del rivestimento trapuntato. Le cuciture sullo schienale sono dettagli d'alta sartoria che evidenziano la cura nel disegno. Questa comoda poltroncina dallo stile classico è disponibile in un'ampissima gamma di colorazioni che le consentono di armonizzarsi e valorizzare gli ambienti di ogni abitazione.

A seat that stands out for the devoted craftsmanship of the quilted cover. The seams on the back are haute couture details that highlight the care in the design. This comfortable classic-style armchair is available in a very wide range of colors that allow it to harmonize and enhance the rooms of any home.



● S050 Betta
seduta - chair
VE05

S050 Betta | seduta - chair | P90





● S050 Betta
seduta - chair
VE05



● S050 Betta
seduta - chair
B02





51x57 H. 83
20"x22.4" H. 32.6"

● S050 Betta
seduta - chair
P90 - P02 - P19



Thelma

Design
Studio Ozeta

Un'elegante poltroncina dallo schienale avvolgente e dalla seduta ergonomica. La base è in legno massello che si coordina con i piani dei tavoli della collezione OZZIO ITALIA. Il legno, declinato nelle tonalità attuali è assoluto protagonista del living contemporaneo.

An elegant armchair with a wrapping backrest and ergonomic seat. A wooden structure that matches the brand wooden table tops OZZIO ITALIA. The wood, absolute protagonist of contemporary living.



● S456 Thelma
seduta - chair
P11 PZ51



S456 Thelma | seduta - chair | P01 PW94 - P20 PW96 - P11 PZ51



● S456 Thelma
seduta - chair
VE04 PW94



51,5x58 H. 83
20.2"x22.8" H. 32.6"

● S456 Thelma
seduta - chair
B01 PW96

Sally • Sveva Selena • Siria

Design
Marco Pozzoli

Una famiglia di poltroncine dalla seduta morbida e avvolgente, presentate con diversi rivestimenti. Le cuciture sullo schienale ne disegnano le forme e lasciano trasparire la morbidezza. Basamenti diversi, sia nel disegno che nel materiale, offrono molteplici possibilità di abbinamenti per soddisfare ogni ambiente e circostanza.

A family of armchairs with a soft and cosy seat, presented with different covers. The seams on the backrest design the shapes and let the softness shine through. Different bases, both in design and material, offer multiple possibilities of combinations to satisfy every environment and circumstance.



● S058 Sally
seduta - chair
P90 PW94

● S059 Sveva
seduta - chair
P90 MT97

● S060 Selena
seduta - chair
P90 PW96

● S061 Siria
seduta - chair
P90



S059 Sveva
seduta - chair | VE04 MT97

S058 Sally
seduta - chair | P10 PW91

S061 Siria
seduta - chair | P18

S060 Selena
seduta - chair | B02 PW96



S060 Selena | seduta - chair | B02 PW96



● S059 Sveva
| seduta - chair
| P90 MT97

● X016 Panto
| libreria - bookcase
| (B) PW96 CR14 MT97



SALLY



57x57 H. 82
22.4"x22.4" H. 32.2"

SVEVA



57x57 H. 82
22.4"x22.4" H. 32.2"

SELENA



57x57 H. 83
22.4"x22.4" H. 32.6"

SIRIA



57x57 H. 83
22.4"x22.4" H. 32.6"

● S061 Siria
seduta - chair
P90

● T234 Gem
tavolo fisso - fix table
CR17 MT97



Sofia

Design
Studio Ozeta

Sofia rappresenta il connubio perfetto tra semplicità e modernità. È interamente rivestita e le sue finiture monomateriche sono impreziosite da fini cuciture sullo schienale. Grazie a queste, la curva dello schienale assume differenti tonalità in base all'inclinazione luminosa, creando sofisticati giochi cromatici.

Sofia represents the perfect combination of simplicity and modernity. It is fully upholstered and its mono-material finishes are embellished with fine stitching on the backrest. Thanks to these, the curve of the back takes on different shades based on the angle of the light, creating sophisticated chromatic effects.



● S316 Sofia
seduta - chair
P19





● S316 Sofia
seduta - chair
P19

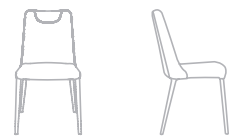

47x56 H. 85
18.5"x22" H. 33.4"

● S316 Sofia
seduta
chair
B01

● T312 Bravo Allungabile
tavolo allungabile
extendable table
CC11 MT97

● X311 Giulia
madia
sideboard
VB01 X17 MT97



Lunette

Design
Studio Ozeta

Seduta dal design logico e dalle forme elementari, arricchita dalle preziose finiture e dalla particolare attenzione al dettaglio nei rivestimenti. Un'idea di seduta che verte verso comodità ed un piacevole utilizzo.

Seat with a logical design and elementary shapes, enriched by precious finishes and by a particular attention to the detail of the coverings. A concept of sitting that focuses on comfort and pleasant use.



● S322 Lunette
seduta - chair
P18



S322 Lunette | seduta - chair | C32

● S322 Lunette
seduta - chair
C32



● S322 Lunette
seduta - chair
P90





45x55 H. 84
17.7"x21.6" H. 33"

● S322 Lunette
seduta - chair
P20

● T241 4x4 Fisso
tavolo fisso - fix table
CM98 MT12

Olimpia • Gilda Atena • Demetra

Design
Studio Ozeta

Elementi di design capaci di provocare un piacevole contrasto sensoriale, grazie all'unione delle delicate finiture della seduta e alla struttura slanciata della base. Contemporaneità e perfezione delle proporzioni ne definiscono il carattere l'abilità a durare nel tempo, prescindendo dall'alternarsi delle mode.

Design elements capable of provoking a pleasant sensory contrast, thanks to the union of the delicate finishes of the seat and the slender structure of the base. Contemporaneity and perfection of proportions define its character, its ability to be durable against trends alternation.



● S053 Olimpia
seduta - chair
P04 PW94



● S461 Gilda
seduta - chair
P04 MT97



● S051 Atena
seduta - chair
P04 PW96



● S052 Demetra
seduta - chair
P04



S052 Demetra | seduta - chair | P02



● S053 Olimpia
seduta - chair
EP54 PW94



● S053 Olimpia
seduta - chair
P11 PW94





OLIMPIA



51x57 H. 82
20"x22.4" H. 32.2"

GILDA



51x57 H. 81
20"x22.4" H. 31.8"

ATENA



51x57 H. 82
20"x22.4" H. 32.2"

DEMETRA



51x57 H. 83
20"x22.4" H. 32.6"

● S051 Atena
seduta - chair
B03 PZ51

● S052 Demetra
seduta - chair
P04

● S053 Olimpia
seduta - chair
P11 PW94

● S461 Gilda
seduta - chair
VE03 MT97



Delia • Halia Eliot • Nelson

Design
Studio Ozeta

Praticità, versatilità e comodità racchiudono l'essenza di queste eccezionali poltroncine. Quattro differenti tipologie di base per sostenere una seduta che ci invita ad accomodarci e ci avvolge in un generoso abbraccio. I braccioli nascono come sagome ampie e curvilinee, solide ed ergonomiche.

Practicality, versatility and comfort enclose the essence of these exceptional armchairs. Four different types of base to support a seat that invites us to sit down and envelops us in a generous hug. The armrests are born with large and curvilinear shapes, solid and ergonomic.



● S453 Delia
seduta - chair
VE05 PW94



● S462 Halia
seduta - chair
VE05 MT97



● S452 Eliot
seduta - chair
VE05 PW96



● S450 Nelson
seduta - chair
VE05



S453 Delia | seduta - chair | P18 PZ51 - P01 PW91 - P20 PW94



● S450 Nelson
seduta - chair
P18



● S452 Eliot
seduta - chair
P11 PW91





DELIA



61x57 H. 80
24"x22.4" H. 31.4"

HALIA



61x57 H. 79
24"x22.4" H. 31.1"

ELIOT



63x57 H. 82
24.8"x22.4" H. 32.2"

NELSON

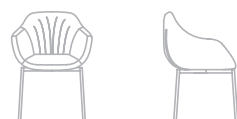

61x57 H. 82
24"x22.4" H. 32.2"

● S450 Nelson
seduta - chair
VE05

● S452 Eliot
seduta - chair
VE03 PW97

● S453 Delia
seduta - chair
B01 PW96

● S462 Halia
seduta - chair
EP50 MT98



Fiona • Zelda Gavia • Ten

Design
Studio Ozeta

Il design di queste sedute non scende a compromessi con il comfort. Un'icona di stile dalle forme morbide che si sposano perfettamente con un living moderno come con uno spazio office informale e generano un senso di ordine e raffinatezza. Una seduta versatile dalle geometrie familiari, proporzioni generose e linee avvolgenti.

The design of these seats does not compromise on comfort. A style icon with soft shapes that blend perfectly with a modern living room and with an informal office space. It generates a sense of order and refinement. A versatile seat with familiar geometries, generous proportions and enveloping lines.



● S447 Fiona
seduta - chair
EP52 PW94

● S460 Zelda
seduta - chair
EP52 MT97

● S448 Gavia
seduta - chair
EP52 PW96

● S449 Ten
seduta - chair
EP52



S460 Zelda | seduta - chair | VE05 MT97 - P20 MT98 - P10 MT97



● S448 Gavia
seduta - chair
VE01 PW91



● S449 Ten
seduta - chair
P18





FIONA



67x61 H. 86
26.3"x24" H. 33.8"

ZELDA



67x61 H. 81
26.3"x24" H. 31.8"

GAVIA



67x61 H. 86
26.3"x24" H. 33.8"

TEN



67x61 H. 87
26.3"x24" H. 34.2"

● S448 Gavia
seduta - chair
VE05 PW96

● S447 Fiona
seduta - chair
EP50 PW96

● S460 Zelda
seduta - chair
EP04 MT98

● S449 Ten
seduta - chair
P05



Nexus

Design
Studio Ozeta

Accostando le sottili gambe slanciate in metallo, alla morbida texture della seduta, e combinando la simmetria delle forme all'ergonomia, otteniamo Nexus. Una seduta pensata per l'area pranzo, capace di creare gli abbinamenti più disparati.

By combining slender metal legs with the soft texture of the seat, and combining symmetry of form with ergonomics, we obtain Nexus. A seat designed for the dining area, capable of creating the most diverse combinations.



● S318 Nexus
seduta - chair
EP18 MT98





S318 Nexus | seduta - chair | EP50 MT98



● S318 Nexus
seduta - chair
EP03 MT98 - EP50 MT98 - EP52 MT98



43x53 H. 89
16.9"x20.8" H. 35"

● S318 Nexus
seduta - chair
EP55 MT98 - EP03 MT98 - EP13 MT98 - EP14 MT98

Plio

Design
Marco Pozzoli & Studio Ozeta

Sedia pieghevole dal design fresco ed essenziale con struttura in metallo seduta e schienale in polipropilene. Il suo disegno lineare la rende complemento ideale per le versioni di tavoli "space saving" e per l'ambiente cucina pranzo informale.

Folding chair with a fresh and pure design, with metal structure and polypropylene seat and back. Its simple style makes it perfect for the "space saving" collection and for the casual kitchen living.



● S208 Plio
sedia pieghevole - folding chair
PL08 MT97



S208 Plio | seduta - chair | PL18 MT98



● S208 Plio
sedia pieghevole - folding chair
PL01 MT91 - PL08 MT97 - PL18 MT98



● S208 Plio
sedia pieghevole
folding chair
PL08 MT97

● S210 Gancio
gancio Ripiego e Plio
Ripiego and Plio hook
MT98



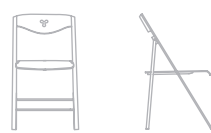

45x47,7 H. 79,5
17.7"x18.7" H. 31.3"

● S208 Plio
sedia pieghevole
folding chair
PL08 MT97

● S011 Cubix
pouf trasformabile
transformable pouf
VE05 MT97

● T101 Su e Giù
tavolino trasformabile
transformable table
PW94



Ripiego

Design
Giuliano Cappelletti
& Studio Ozeta

Elegante e salvaspazio, la seduta Ripiego è in grado di mimetizzarsi in solo 90 cm di altezza per 7 di spessore da chiusa. Le sue pregiate finiture in legno si sposano con la robusta struttura in metallo.

Elegant and space-saving, the Ripiego chair is able to blend into just 90 cm high by 7 thick when closed. Its precious wood finishes are combined with the strong metal structure.



● S215 Ripiego
sedia pieghevole - folding chair
PW96 MT97

S215 Ripiego | sedia pieghevole - folding chair | PW91 MT97 - PW96 MT98





● S215 Ripiego
sedia pieghevole - folding chair
PW94 MT98

● S210 Gancio
gancio Ripiego e Plio - Ripiego and Plio hook
MT98



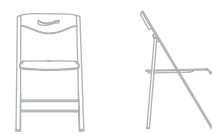

44,5x46 H. 77,5
17.5"x18.1" H. 30.5"

● S215 Ripiego
sedia pieghevole - folding chair
PW94 MT97

● T021 A4
consolle - console
PZ94

● X016 Panto
libreria - bookcase
(A) PW96 CR21 MT97



Informazioni tecniche



Technical
information

Tavoli allungabili

Extendable tables

T240 4x4

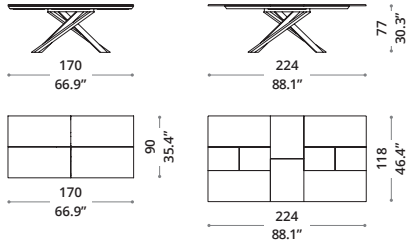

Design:
Giulio Manzoni

Tavolo da pranzo allungabile con base in metallo, piani e allunghe in legno, cemento o Marble Glass. Scorrimento guide metalliche e piedini regolabili in altezza.

Extendable dining table with metal base, wooden, concrete or Marble Glass tops and extensions. Sliding metal guides and height-adjustable feet.

STRUTTURA

STRUCTURE

Metallo - Metal

PIANO (170x90 cm)

TOP (66.9"x35.4")

Legno - Wood

Cemento - Cement



Fino a 10 posti
Up to 10 seats

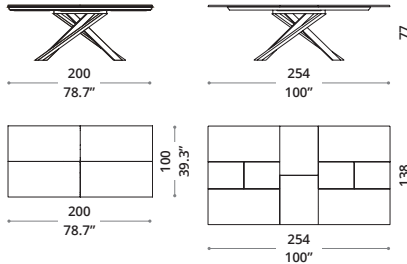

Fino a 12 posti
Up to 12 seats

STRUTTURA

STRUCTURE

Metallo - Metal

PIANO (200x100 cm)

TOP (78.7"x39.3")

Legno - Wood

Cemento - Cement

Marble Glass

Tutti i prodotti sono brevettati

Our products are all patented

LEGENDA

LEGEND



Numero massimo commensali consigliati
Number of seats suggested



Articolo dotato di rotelle
Equipped with castors



Disco girevole
Swivelling tray



Piede
Feet



Rotazione con molla di ritorno
Return spring swivel



Girevole a 360°
360° swivel

*Tutte misure sono espresse in cm e pollici
All dimensions are expressed in cm and inches

T256 ARIZONA

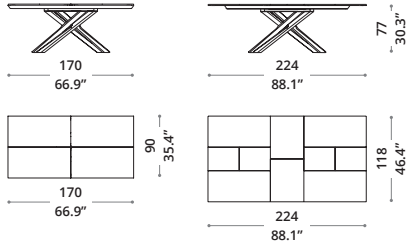

Design:
Giulio Manzoni

Tavolo da pranzo allungabile con base in legno, piani e allunghe in legno con scorrimento guide metalliche. Piedini regolabili in altezza.

Extendable dining table with wooden base, wooden tops and extensions with sliding metal guides. Height-adjustable feet.

TELAIO

FRAME

Metallo - Metal

PIANO E GAMBE

TOP AND LEGS

Legno - Wood



Fino a 12 posti
Up to 12 seats

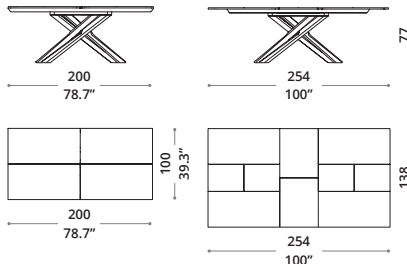

SCHEDE TECNICHE | Technical sheet

Tavoli allungabili Extendable tables

T232 BIG ROUND

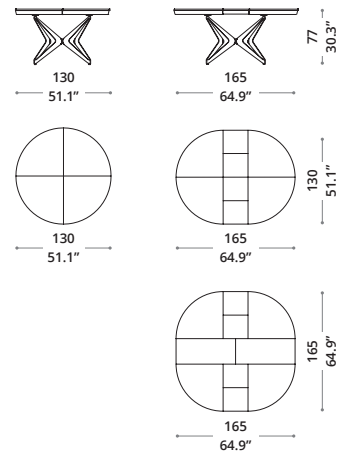

Design:
Marco Pozzoli - Andrea Lucatello

Tavolo da pranzo allungabile e allargabile con base in metallo, piani e allunghe in legno. Scorrimento guide metalliche e piedini regolabili in altezza.

Extendable and expandable dining table with metal base, wooden tops and extensions. Sliding metal guides and height-adjustable feet.



Fino a 10 posti
Up to 10 seats

STRUTTURA STRUCTURE

Metallo - Metal

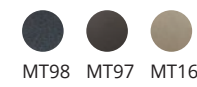

PIANO TOP

Legno - Wood



T316 CIRKLE

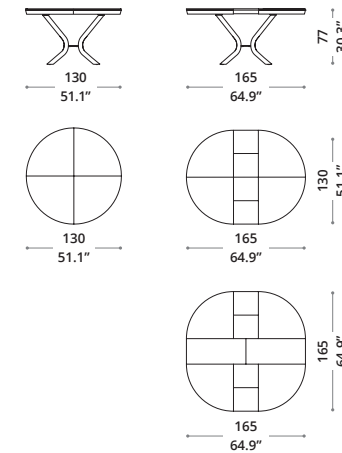

Design:
Studio Ozeta - Marco Pozzoli

Tavolo da pranzo allungabile e allargabile con base in metallo, piani e allunghe in legno. Scorrimento guide metalliche e piedini regolabili in altezza.

Extendable and expandable dining table with metal base, wooden tops and extensions. Sliding metal guides and height-adjustable feet.



Fino a 10 posti
Up to 10 seats

STRUTTURA STRUCTURE

Metallo - Metal



PIANO TOP

Legno - Wood



T246 BOMBO ALLUNGABILE

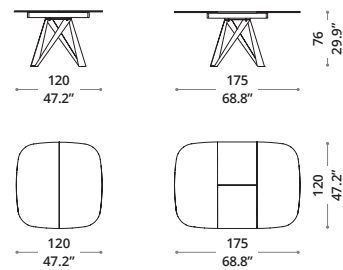

Design:
Gabriele Cappelletti - Studio Ozeta

Tavolo da pranzo con nuovo meccanismo di allungamento sincronizzato dei piani. Il sollevamento dell'allunga è agevolato da un binario integrato nel carter. Base in metallo verniciato, piano disponibile in diverse finiture. Piedini regolabili in altezza.

Dining table with new synchronised table top elongation mechanism. The lifting of the extension is facilitated by a rail integrated in the casing. Base in painted metal, top available in different finishes. Height-adjustable feet.



Fino a 10 posti
Up to 10 seats

STRUTTURA STRUCTURE

Metallo - Metal



PIANO TOP

Cristallo antimpronta - Mark-less glass

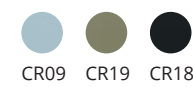

Ceramica - Pyroceram



T254 DNA

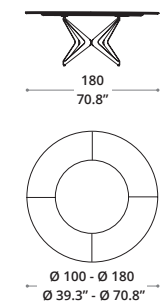

Design:
Andrea Lucatello

Tavolo con vassoio girevole Ø 100 incassato nel piano, la rotazione è di 360° su asse verticale. Basamento in metallo e piedini regolabili in altezza.

Table with Ø 100 swivel tray embedded in the top, the rotation is 360° on a vertical axis. Metal base and height-adjustable feet.



Fino a 10 posti
Up to 10 seats



Disco girevole
Swivelling tray

STRUTTURA STRUCTURE

Metallo - Metal



PIANO TOP

Legno - Wood



DISCO CENTRALE SWIVELLING TRAY

Ceramica - Pyroceram



T312 BRAVO ALLUNGABILE

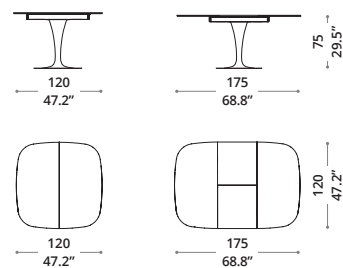

Design:
Studio Ozeta

Tavolo da pranzo con nuovo meccanismo di allungamento sincronizzato dei piani. Il sollevamento dell'allunga è agevolato da un binario integrato nel carter. Base in metallo verniciato.

Dining table with new synchronised table top elongation mechanism. The lifting of the extension is facilitated by a rail integrated in the casing. Painted metal base.



Fino a 10 posti
Up to 10 seats

STRUTTURA STRUCTURE

Metallo - Metal



PIANO TOP

Cristallo antimpronta - Mark-less glass

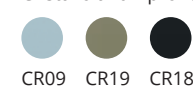

Ceramica - Pyroceram

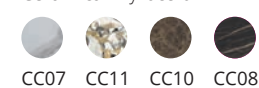

T310 ECLIPSE

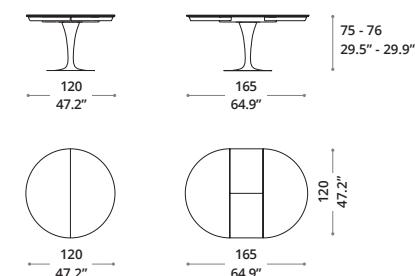

Design:
Studio Ozeta

Tavolo da pranzo allungabile. Base in metallo verniciato, piano disponibile in diverse finiture.

Extendable dining table. Base in painted metal, top available in different finishes.



Fino a 8 posti
Up to 8 seats

STRUTTURA STRUCTURE

Metallo - Metal



PIANO TOP

Cristallo - Glass



Cristallo antimpronta - Mark-less glass



Ceramica - Pyroceram



Marble Glass

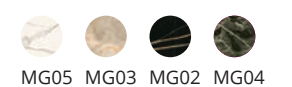

Tavoli allungabili

Extendable tables

T315 ECLIPSE LEGNO

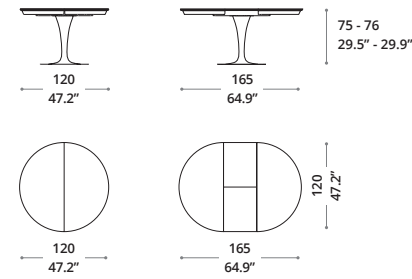

Design:
Studio Ozeta

Tavolo da pranzo allungabile.
Base in metallo verniciato, piano
e allunga centrale in legno.

Extendable dining table.
Base in painted metal, top
and central extension in wood.



Fino a 8 posti
Up to 8 seats

STRUTTURA STRUCTURE

Metallo - Metal



PIANO TOP

Legno - Wood



T244 EMISFERO

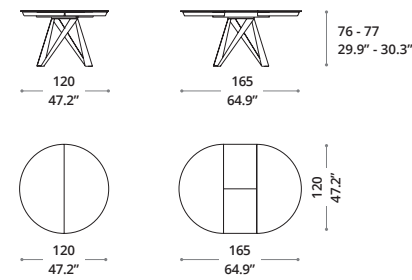

Design:
Gabriele Cappelletti - Studio Ozeta

Tavolo da pranzo allungabile.
Base in metallo verniciato, piano
disponibile in diverse finiture.
Piedini regolabili in altezza.

Extendable dining table.
Base in painted metal, top available
in different finishes. Height-adjustable
feet.



Fino a 8 posti
Up to 8 seats

STRUTTURA STRUCTURE

Metallo - Metal

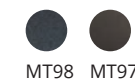

PIANO TOP

Cristallo - Glass

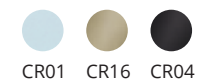

Cristallo antimpronta - Mark-less glass



Ceramica - Pyroceram



Marble Glass

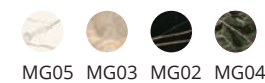

T236 EMISFERO LEGNO

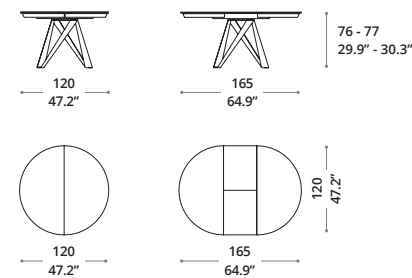

Design:
Gabriele Cappelletti - Studio Ozeta

Tavolo da pranzo allungabile.
Base in metallo verniciato, piano
e allunga centrale in legno.
Piedini regolabili in altezza.

Extendable dining table.
Base in painted metal, top
and central extension in wood.
Height-adjustable feet.



Fino a 8 posti
Up to 8 seats

STRUTTURA STRUCTURE

Metallo - Metal



PIANO TOP

Legno - Wood



T238 FIL8

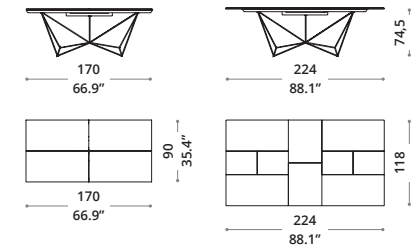

Design:
Giulio Manzoni

Tavolo da pranzo allungabile
con piani e allunghe in legno,
cemento o Marble Glass.
Scorrimo guide metalliche
e basamento in tondino metallico.
Piedini regolabili in altezza.

Extendable dining table with
wooden, concrete or Marble Glass
tops and extensions. Sliding metal
guides and metal rod base.
Height adjustable feet.



Fino a 10 posti
Up to 10 seats

STRUTTURA STRUCTURE

Metallo - Metal



PIANO (170x90 cm) TOP (66.9"x35.4")

Legno - Wood



Cemento - Cement

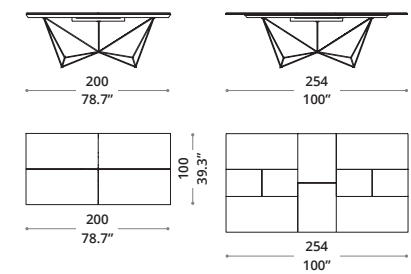
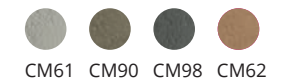

Fino a 12 posti
Up to 12 seats

STRUTTURA STRUCTURE

Metallo - Metal

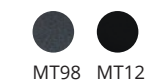

PIANO (200x100 cm) TOP (78.7"x39.3")

Legno - Wood



Cemento - Cement

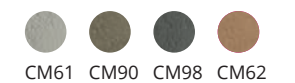

Marble Glass

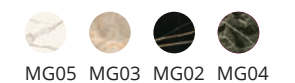

T202 LYCOS

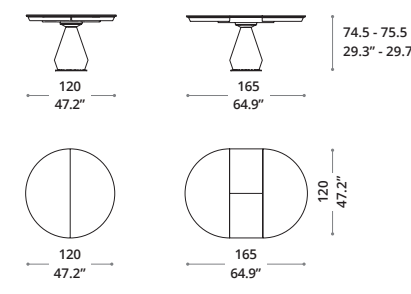

Design:
Marco Pozzoli

Tavolo da pranzo allungabile.
Base in metallo verniciato
o lavorazione cemento, piano
disponibile in diverse finiture.

Extendable dining table.
Base in painted metal or concrete,
top available in different finishes.



Fino a 8 posti
Up to 8 seats

STRUTTURA STRUCTURE

Metallo - Metal



Cemento - Cement

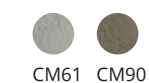

PIANO TOP

Cristallo - Glass



Cristallo antimpronta - Mark-less glass



Ceramica - Pyroceram



Marble Glass



Tavoli allungabili

Extendable tables

T203 LYCOS LEGNO

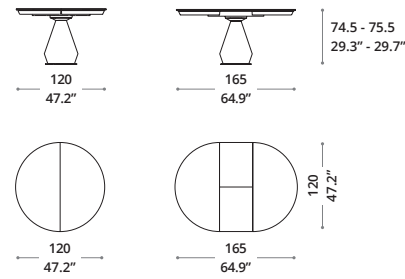

Design:
Marco Pozzoli

Tavolo da pranzo allungabile.
Base in metallo verniciato
o lavorazione cemento, piano
e allunga centrale in legno.

Extendable dining table.
Base in painted metal or concrete,
wooden top and central extension.



Fino a 8 posti
Up to 8 seats

STRUTTURA STRUCTURE

Metallo - Metal



Cemento - Cement



PIANO TOP

Legno - Wood



PZ51

T251 RANDOM

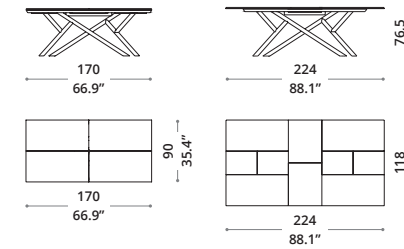

Design:
Giulio Manzoni

Tavolo da pranzo allungabile
con piani e allunghe in legno,
cemento o Marble Glass.
Scorrimiento guide metalliche
e basamento in tubo metallico,
progettato con saldature e giunzioni
a vite. Piedini regolabili in altezza.

Extendable dining table with wooden,
concrete or Marble Glass tops and
extensions. Sliding metal guides and
metal tube base, designed with welds
and screw joints. Height-adjustable
feet.



Fino a 10 posti
Up to 10 seats

STRUTTURA STRUCTURE

Metallo - Metal

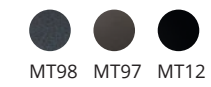

PIANO (170x90 cm) TOP (66.9"x35.4")

Legno - Wood



PZ93 PZ91 PZ94 PZ51

Cemento - Cement



T200 METRÒ

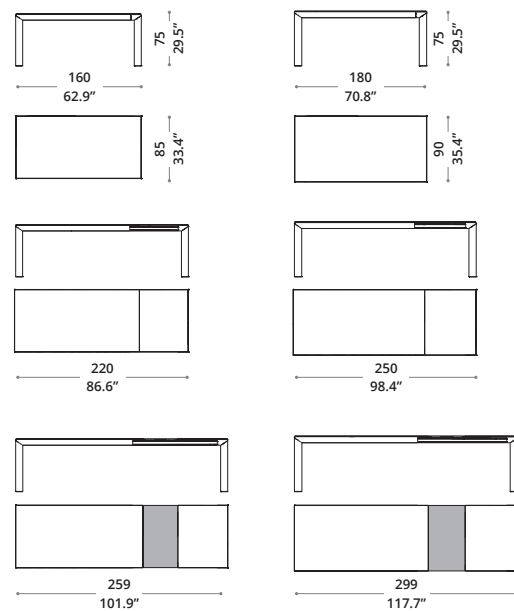

Design:
Toshiyuki Yoshino - Studio Ozeta

Tavolo da pranzo allungabile
in estruso di alluminio. Piano
e prolunga a scomparsa in cristallo
o vetro stratificato ceramica. Due
gambe dotate di ruote e prolunga
supplementare opzionale.

Extendable dining table in aluminium
extrudate. Top and retractable
extension in glass or laminated
ceramic glass. Two legs equipped
with wheels and optional additional
extension.



Fino a 14 posti
Up to 14 seats



Dotato di rotelle
Equipped with
castors

STRUTTURA STRUCTURE

Metallo - Metal



PIANO E ALLUNGHE TOP AND EXTENSIONS

Cristallo antimpronta - Mark-less glass

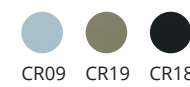

Ceramica - Pyroceram

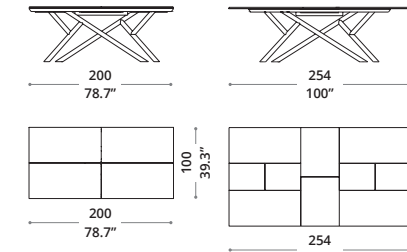

Design:
Luca Tonelli - Davide Carlesi

Fino a 12 posti
Up to 12 seats

STRUTTURA STRUCTURE

Metallo - Metal

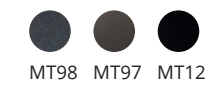

PIANO (200x100 cm) TOP (78.7"x39.3")

Legno - Wood



PZ93 PZ91 PZ94 PZ51

Cemento - Cement



Marble Glass

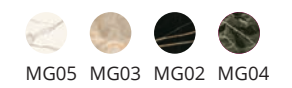

T258 PIVOT

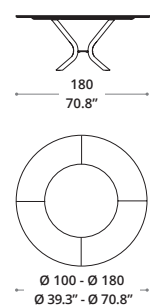

Design:
Studio Ozeta + Marco Pozzoli

Tavolo con vassoio girevole Ø 100
incassato nel piano, la rotazione
è di 360° su asse verticale.
Basamento in metallo e piedini
regolabili in altezza.

Table with Ø 100 swivel tray
embedded in the top, the rotation
is 360° on a vertical axis. Metal base
and height adjustable feet.



Fino a 10 posti
Up to 10 seats



Disco girevole
Swivelling tray

STRUTTURA STRUCTURE

Metallo - Metal



PIANO TOP

Legno - Wood



PZ51

DISCO CENTRALE SWIVELLING TRAY

Ceramica - Pyroceram

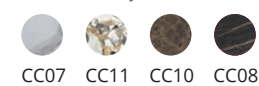

T314 VELIERO

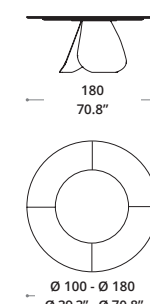

Design:
Luca Tonelli - Davide Carlesi

Tavolo con vassoio girevole Ø 100
incassato nel piano, la rotazione
è di 360° su asse verticale.
Basamento in legno composto
da tre vele sagomate.

Table with Ø 100 swivel tray
embedded in the top, the rotation
is 360° on a vertical axis.
Wooden base consisting of three
shaped sails.



Fino a 10 posti
Up to 10 seats



Disco girevole
Swivelling tray

GAMBE E TOP LEGS AND TOP

Legno - Wood



PZ51

DISCO CENTRALE SWIVELLING TRAY

Ceramica - Pyroceram



Tavoli fissi

Fix tables

T241 4x4 FISSO

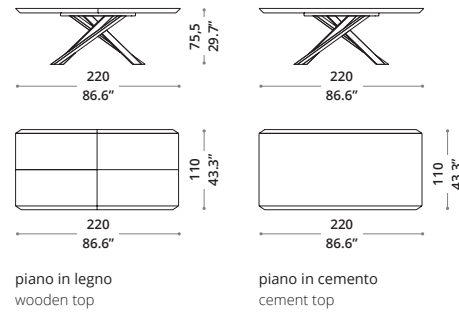

piano in legno
wooden top

piano in cemento
cement top

Design:
Giulio Manzoni

Tavolo da pranzo fisso con basamento in metallo verniciato e piedini regolabili in altezza. Vasta gamma di piani fissi in diverse dimensioni, forme e finiture.

Fixed dining table with painted metal base and height-adjustable feet. Wide range of tops in different sizes, shapes and finishes.



Fino a 10 posti
Up to 10 seats

STRUTTURA STRUCTURE

Metallo - Metal

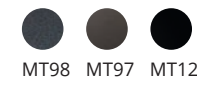

PIANO TOP

Legno - Wood



Cemento - Cement

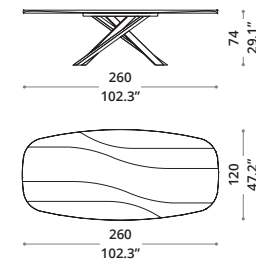

piano intarsiato
inlaid top



Fino a 12 posti
Up to 12 seats

STRUTTURA STRUCTURE

Metallo - Metal



PIANO INTARSIATO INLAYED TOP

Legno - Wood



T257 ARIZONA FISSO

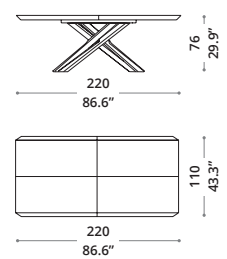

piano in legno
wooden top

Design:
Giulio Manzoni

Tavolo da pranzo fisso con basamento in legno sagomato. Vasta gamma di piani fissi in diverse dimensioni, forme e finiture.

Fixed dining table with shaped wooden base. Wide range of tops in different sizes, shapes and finishes.



Fino a 10 posti
Up to 10 seats

PIANO E GAMBE TOP AND LEGS

Legno - Wood

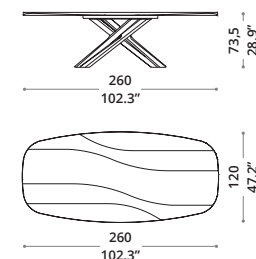

piano intarsiato
inlaid top



Fino a 12 posti
Up to 12 seats

PIANO INTARSIATO E GAMBE INLAYED TOP AND LEGS

Legno - Wood



T401 BIG ROUND FISSO

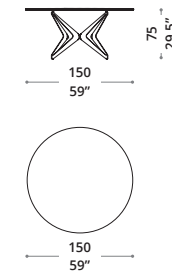

Design:
Studio Ozeta - Andrea Lucatello

Tavolo da pranzo con piano fisso circolare Ø 150 e basamento in metallo verniciato.

Dining table with fixed circular Ø 150 top and painted metal base.



Fino a 8 posti
Up to 8 seats

STRUTTURA STRUCTURE

Metallo - Metal

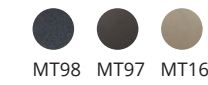

PIANO TOP

Ceramica - Pyroceram



T402 CIRCLE FISSO

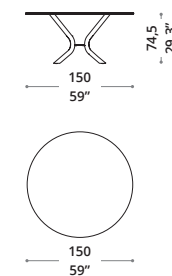

Design:
Marco Pozzoli

Tavolo da pranzo con piano fisso circolare Ø 150 e basamento in metallo verniciato.

Dining table with fixed circular Ø 150 top and painted metal base.



Fino a 8 posti
Up to 8 seats

STRUTTURA STRUCTURE

Metallo - Metal

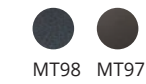

PIANO TOP

Ceramica - Pyroceram



T405 ECLIPSE FISSO

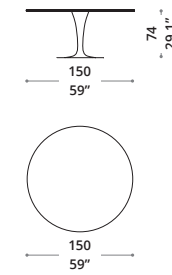

Design:
Studio Ozeta

Tavolo da pranzo con piano fisso circolare Ø 150 e basamento in metallo verniciato.

Dining table with fixed circular Ø 150 top and painted metal base.



Fino a 8 posti
Up to 8 seats

STRUTTURA STRUCTURE

Metallo - Metal



PIANO TOP

Ceramica - Pyroceram



Tavoli fissi

Fix tables

T404 EMISFERO FISSO

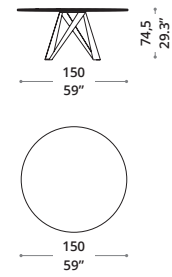

Design:
Studio Ozeta

Tavolo da pranzo con piano fisso circolare Ø 150. Basamento in metallo verniciato e piedini regolabili in altezza.

Dining table with fixed circular Ø 150 top. Painted metal base and height-adjustable feet.



Fino a 8 posti
Up to 8 seats

STRUTTURA STRUCTURE

Metallo - Metal



PIANO TOP

Ceramica - Pyroceram



T237 FIL8 FISSO

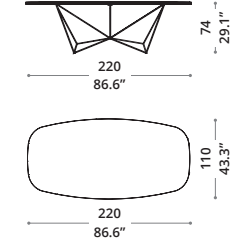

piano in ceramica e Marble Glass
pyroceram and Marble Glass top



Fino a 10 posti
Up to 10 seats

STRUTTURA STRUCTURE

Metallo - Metal



PIANO (220x110 cm) TOP (86.6"x43.3")

Ceramica - Pyroceram



Marble Glass



T237 FIL8 FISSO

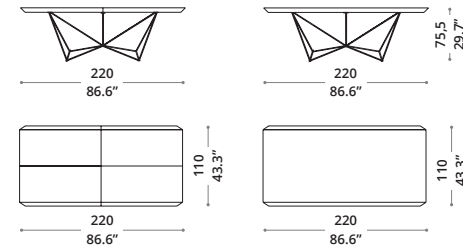

piano in legno
wooden top

piano in cemento
cement top

Design:
Giulio Manzoni

Tavolo da pranzo fisso con basamento in tondino metallico e piedini regolabili in altezza. Vasta gamma di piani fissi in diverse dimensioni, forme e finiture.

Fixed dining table with metal rod base and height-adjustable feet. Wide range of fixed tops in different sizes, shapes and finishes.



Fino a 10 posti
Up to 10 seats

STRUTTURA STRUCTURE

Metallo - Metal



PIANO (220x110 cm) TOP (86.6"x43.3")

Legno - Wood



Cemento - Cement

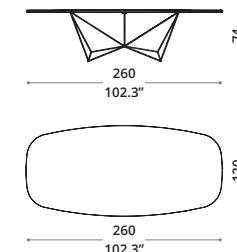
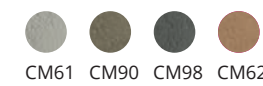

piano in ceramica
pyroceram top

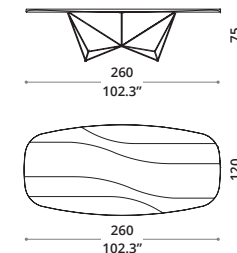

piano intarsiato
inlaid top



Fino a 12 posti
Up to 12 seats

STRUTTURA STRUCTURE

Metallo - Metal

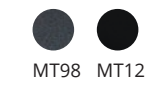

PIANO (260x120 cm) TOP (102.3"x47.2")

Ceramica - Pyroceram



Fino a 12 posti
Up to 12 seats

STRUTTURA STRUCTURE

Metallo - Metal



PIANO (260x120 cm) TOP (102.3"x47.2")

Legno - Wood

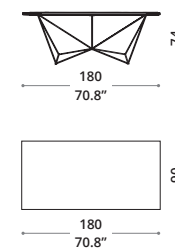

piano in Marble Glass
Marble Glass top



Fino a 8 posti
Up to 8 seats

STRUTTURA STRUCTURE

Metallo - Metal



PIANO (180x90 cm) TOP (70.8"x35.4")

Marble Glass

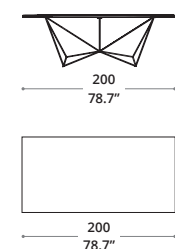
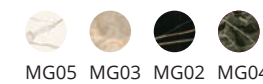

piano in ceramica e Marble Glass
pyroceram and Marble Glass top



Fino a 10 posti
Up to 10 seats

STRUTTURA STRUCTURE

Metallo - Metal



PIANO (200x100 cm) TOP (78.7"x39.3")

Ceramica - Pyroceram

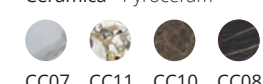

Marble Glass



Tavoli fissi

Fix tables

T234 GEM

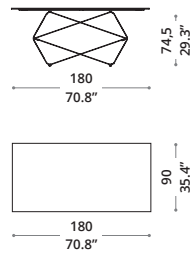

piano in cristallo e Marble Glass
glass and Marble Glass top

Design:
Andrea Lucatello

Tavolo da pranzo fisso con basamento in lamiera verniciata e piedini regolabili in altezza. Vasta gamma di piani fissi in diverse dimensioni, forme e finiture.

Fixed dining table with painted sheet metal base and heightadjustable feet. Wide range of tops in different sizes, shapes and finishes.



Fino a 8 posti
Up to 8 seats

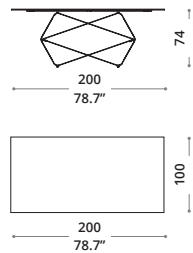

piano in cristallo, ceramica e Marble Glass
pyroceram, glass and Marble Glass top



Fino a 10 posti
Up to 10 seats

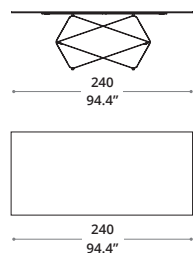

piano in cristallo
glass top



Fino a 12 posti
Up to 12 seats

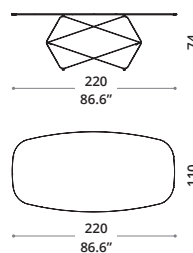

piano in cristallo, ceramica e Marble Glass
pyroceram, glass and Marble Glass top



Fino a 10 posti
Up to 10 seats

STRUTTURA STRUCTURE

Metallo - Metal



MT16 MT97

PIANO (180x90 cm) TOP (70.8"x35.4")

Cristallo - Glass



CR17

Marble Glass



MG05 MG03 MG02 MG04

STRUTTURA STRUCTURE

Metallo - Metal



MT16 MT97

PIANO (200x100 cm) TOP (78.7"x39.3")

Cristallo - Glass



CR17

Ceramica - Pyroceram



CC07 CC11 CC10 CC08

Marble Glass



MG05 MG03 MG02 MG04

STRUTTURA STRUCTURE

Metallo - Metal



MT16 MT97

PIANO (240x110 cm) TOP (94.4"x43.3")

Cristallo - Glass



CR17 CR21

STRUTTURA STRUCTURE

Metallo - Metal



MT16 MT97

PIANO (220x110 cm) TOP (86.6"x43.3")

Cristallo - Glass



CR17 CR21

Ceramica - Pyroceram



CC07 CC11 CC10 CC08

Marble Glass



MG05 MG03 MG02 MG04

T234 GEM

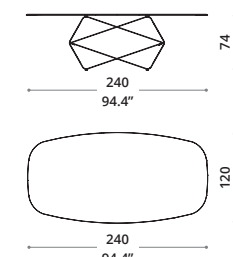

piano in cristallo con bordo diamantato
glass top with diamond edge

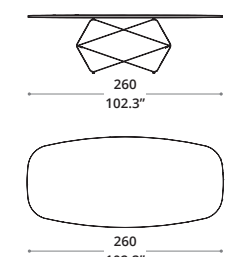

piano in ceramica
pyroceram top

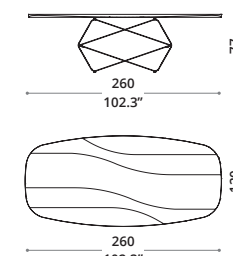

piano intarsiato
inlaid top

T204 LYCOS FISSO

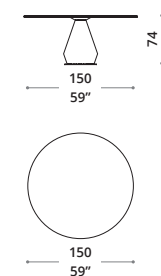

Fino a 12 posti
Up to 12 seats

STRUTTURA STRUCTURE

Metallo - Metal



MT16 MT97

PIANO (240x120 cm) TOP (94.4"x47.2")

Cristallo - Glass



CR17



Fino a 12 posti
Up to 12 seats

STRUTTURA STRUCTURE

Metallo - Metal



MT16 MT97

PIANO (260x120 cm) TOP (102.3"x47.2")

Ceramica - Pyroceram



CC07 CC11 CC10 CC08



Fino a 12 posti
Up to 12 seats

STRUTTURA STRUCTURE

Metallo - Metal



MT16 MT97

PIANO (260x120 cm) TOP (102.3"x47.2")

Legno - Wood



PW61 PW91 PW96 PW97 PW94

PZ51

Design:
Studio Ozeta - Marco Pozzoli

Tavolo da pranzo con piano fisso circolare Ø 150 e base in metallo verniciato o lavorazione cemento.

Dining table with fixed circular Ø 150 top and base in painted metal or concrete.



Fino a 8 posti
Up to 8 seats

STRUTTURA STRUCTURE

Metallo - Metal



MT98 MT97

Cemento - Cement



CM61 CM90



CM98 CM62

PIANO TOP

Ceramica - Pyroceram



CC07 CC11 CC10 CC08

Tavoli fissi

Fix tables

T253 PAPILLON

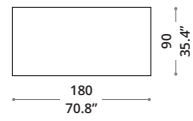
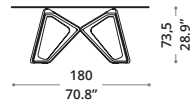

piano in cristallo e Marble Glass
glass and Marble Glass top

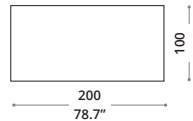
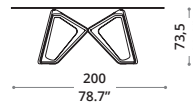

piano in cristallo, ceramica e Marble Glass
pyroceram, glass and Marble Glass top

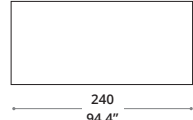
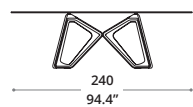

piano in cristallo
glass top

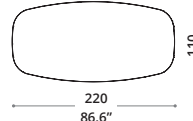
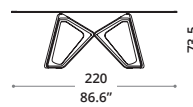

piano in cristallo, ceramica e Marble Glass
pyroceram, glass and Marble Glass top

Design:
Andrea Lucatello

Tavolo da pranzo fisso con base in legno massello. Vasta gamma di piani fissi in diverse dimensioni, forme e finiture.

Fixed dining table with solid wood base. Wide range of tops in different sizes, shapes and finishes.



Fino a 8 posti
Up to 8 seats



Fino a 10 posti
Up to 10 seats



Fino a 12 posti
Up to 12 seats



Fino a 10 posti
Up to 10 seats

STRUTTURA STRUCTURE

Legno - Wood



PIANO (180x90 cm) TOP (70.8"x35.4")

Cristallo - Glass



STRUTTURA STRUCTURE

Legno - Wood



PIANO (200x100 cm) TOP (78.7"x39.3")

Cristallo - Glass



Marble Glass

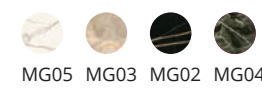

STRUTTURA STRUCTURE

Legno - Wood



PIANO (240x110 cm) TOP (94.4"x43.3")

Cristallo - Glass



STRUTTURA STRUCTURE

Legno - Wood



PIANO (220x110 cm) TOP (86.6"x43.3")

Cristallo - Glass



Marble Glass

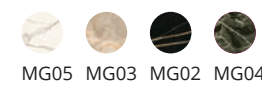

T253 PAPILLON

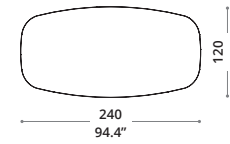
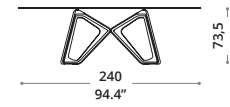

piano in cristallo con bordo diamantato
glass top with diamond edge

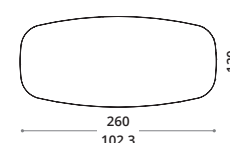
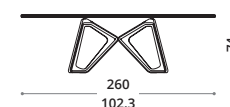

piano in ceramica
pyroceram top

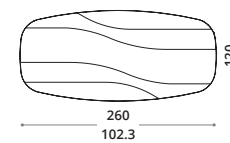
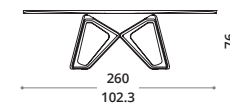

piano intarsiato
inlaid top



Fino a 12 posti
Up to 12 seats

STRUTTURA STRUCTURE

Legno - Wood



PIANO (240x120 cm) TOP (94.4"x47.2")

Cristallo - Glass



Fino a 12 posti
Up to 12 seats

STRUTTURA STRUCTURE

Legno - Wood



PIANO (260x120 cm) TOP (102.3"x47.2")

Ceramica - Pyroceram



Fino a 12 posti
Up to 12 seats

STRUTTURA STRUCTURE

Legno - Wood



PIANO (260x120 cm) TOP (102.3"x47.2")

Legno - Wood



Tavoli fissi

Fix tables

T252 RANDOM FISSO

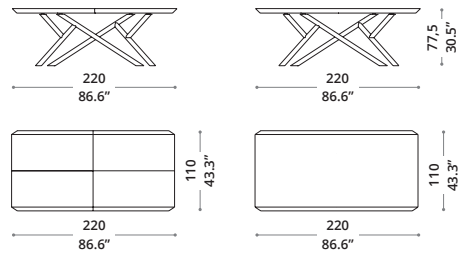

piano in legno
wooden top

piano in cemento
cement top

Design:
Giulio Manzoni

Tavolo da pranzo fisso con base in tubo metallico, progettato con saldature e giunti a vite. Piedini regolabili in altezza. Ampia gamma di piani in diverse dimensioni, forme e finiture.

Fixed dining table with metal tube base, designed with welds and screw joints. Height-adjustable feet. Wide range of tops in different sizes, shapes and finishes.



Fino a 10 posti
Up to 10 seats

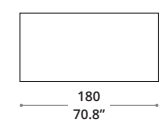
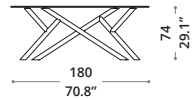

piano in cristallo e Marble Glass
glass and Marble Glass top

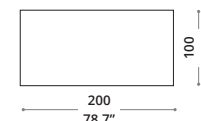
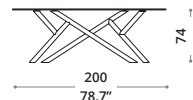

piano in cristallo, ceramica e Marble Glass
pyroceram, glass and Marble Glass top

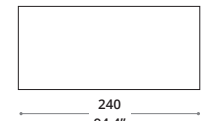
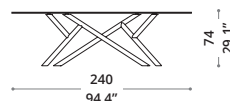

piano in cristallo
glass top

STRUTTURA STRUCTURE

Metallo - Metal

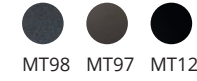

PIANO (220x110 cm) TOP (86.6"x43.3")

Legno - Wood

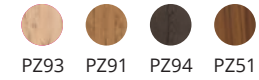

Cemento - Cement

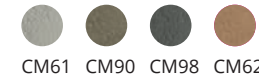

STRUTTURA STRUCTURE

Metallo - Metal

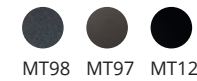

PIANO (180x90 cm) TOP (70.8"x35.40")

Cristallo - Glass



Marble Glass

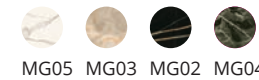

STRUTTURA STRUCTURE

Metallo - Metal

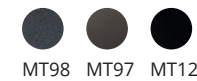

PIANO (200x100 cm) TOP (78.7"x39.3")

Cristallo - Glass



Ceramica - Pyroceram



Marble Glass

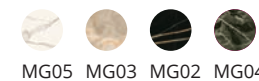

STRUTTURA STRUCTURE

Metallo - Metal

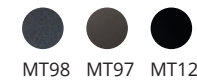

PIANO (240x110 cm) TOP (94.4"x43.3")

Cristallo - Glass



T252 RANDOM FISSO

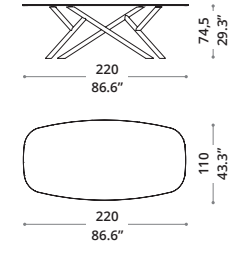

piano in cristallo, ceramica e Marble Glass
pyroceram, glass and Marble Glass top

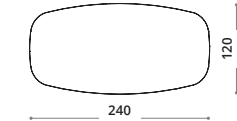
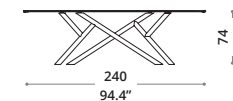

piano in cristallo con bordo diamantato
glass top with diamond edge

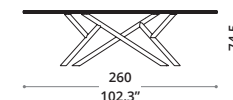

piano in ceramica - pyroceram top

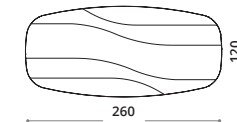
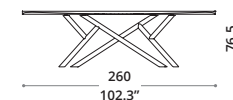

piano intarsiato - inlaid top

T403 VELIERO FISSO

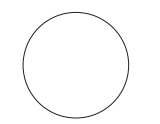
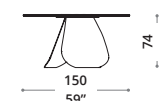

150
59"



Fino a 10 posti
Up to 10 seats

STRUTTURA STRUCTURE

Metallo - Metal

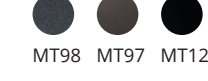

PIANO (220x110 cm) TOP (86.6"x43.3")

Cristallo - Glass

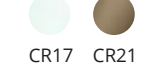

Ceramica - Pyroceram



Marble Glass

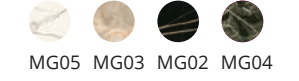

Fino a 12 posti
Up to 12 seats

STRUTTURA STRUCTURE

Metallo - Metal

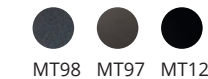

PIANO (240x120 cm) TOP (94.4"x47.2")

Cristallo - Glass



Fino a 12 posti
Up to 12 seats

STRUTTURA STRUCTURE

Metallo - Metal

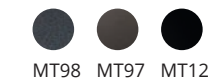

PIANO (260x120 cm) TOP (102.3"x47.2")

Ceramica - Pyroceram



Fino a 12 posti
Up to 12 seats

STRUTTURA STRUCTURE

Metallo - Metal

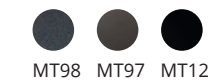

PIANO (260x120 cm) TOP (102.3"x47.2")

Legno - Wood



Design:
Luca Tonelli - Davide Carlesi

Tavolo da pranzo con piano fisso circolare Ø 150 e basamento in legno composto da tre vele sagomate.

Dining table with fixed circular Ø 150 top and wooden base consisting of three shaped sails.



Fino a 8 posti
Up to 8 seats

STRUTTURA STRUCTURE

Legno - Wood

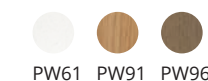

PIANO TOP

Ceramica - Pyroceram



Madie Sideboards

X306 ARMOR

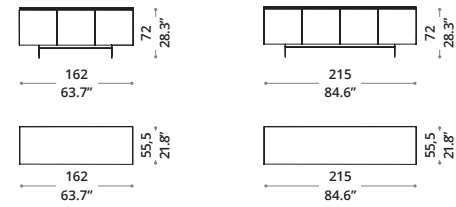

ripiani interni in vetro - glass inner shelves



Design:
Studio Ozeta

Madia con ante, fianchi e piano in ceramica. Ripiani interni in cristallo e piedini in metallo verniciato.

Sideboard with ceramic doors, sides and top. Internal glass shelves and painted metal feet.

PIEDINI FEET

Metallo - Metal



MT98

ANTE, FIANCHI E PIANO DOORS, SIDES AND TOP

Ceramica - Pyroceram



CC07 CC11 CC10 CC08

CASSONE FRAME

Laccati - Lacquers



X06

X302 BRERA

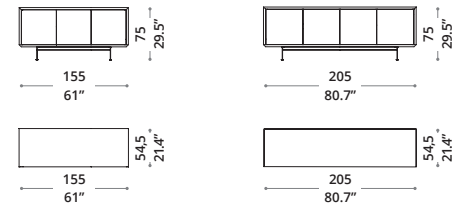

ripiani interni in vetro e cassetti CR21 - glass inner shelves and drawer CR21



Design:
Massimiliano Mornati

Madia con contenitore laccato, ante e fianchi in essenza o laccato. Ripiani interni in cristallo, cassetto in tinta con top e cornice. Piedini in metallo verniciato.

Sideboard with lacquered container, doors and sides in natural or lacquered wood. Interior glass shelves, drawer matching the top and frame. Painted metal feet.

PIEDINI FEET

Metallo - Metal



MT98

PIANO E CORNICE FRAME AND TOP

Laccati - Lacquers



X01 X02 X06



X03 X04 X16



X17 X18 X19



X20 X07

ANTE E FIANCHI DOORS AND SIDES

Legno - Wood



PW61 PW91 PW96 PW97 PW94



PZ93 PZ91 PZ94 PZ51

Laccati - Lacquers



X01 X02 X06 X03 X04



X16 X17 X18 X19 X20



X07

X309 BRERA TV

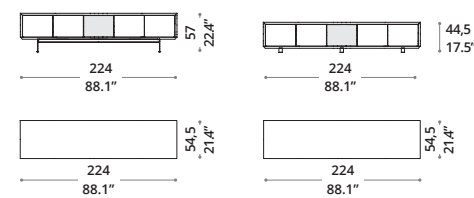

ripiani interni in vetro e cassetti CR21 - glass inner shelves and drawer CR21



piede A feet A

piede B feet B

Design:
Massimiliano Mornati

Madia con contenitore laccato, ante e fianchi in essenza o laccato. Ripiani interni in cristallo e anta centrale in vetro. Piedini in metallo verniciato.

Sideboard with lacquered container, doors and sides in natural or lacquered wood. Internal glass shelves and central glass door. Painted metal feet.

PIEDINI FEET

Metallo - Metal



MT98

PIANO E CORNICE FRAME AND TOP

Laccati - Lacquers



X01 X02 X06



X03 X04 X16



X17 X18 X19



X20 X07

ANTE E FIANCHI DOORS AND SIDES

Legno - Wood



PW61 PW91 PW96 PW97 PW94



PZ93 PZ91 PZ94 PZ51

Laccati - Lacquers



X01 X02 X06 X03 X04



X16 X17 X18 X19 X20



X07

X312 BRERA VETRO

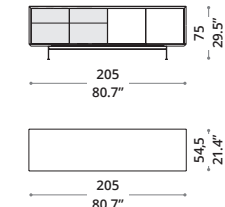

ante laterali e ripiani interni in vetro side doors and inner glass shelves

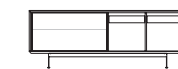

Design:
Massimiliano Mornati

Madia con contenitore, lato sinistro in vetro e destro in essenza o laccato. Luce LED applicata all'interno della porzione vetro. Piedini in metallo verniciato.

Sideboard with container, left side in glass and right in natural or lacquered wood. LED light applied inside the glass portion. Painted metal feet.

PIEDINI FEET

Metallo - Metal



MT98

PIANO E CORNICE FRAME AND TOP

Laccati - Lacquers



X01 X02 X06



X03 X04 X16



X17 X18 X19



X20 X07

ANTE E FIANCHI DOORS AND SIDES

Legno - Wood



PW61 PW91 PW96 PW97 PW94



PZ93 PZ91 PZ94 PZ51

Laccati - Lacquers



X01 X02 X06 X03 X04



X16 X17 X18 X19 X20



X07

ANTE LATERALI SIDE DOORS

Cristallo - Glass



CR21

X311 GIULIA

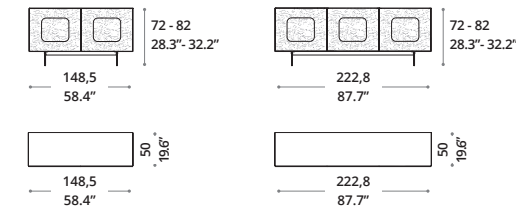

ripiani interni in vetro - glass inner shelves

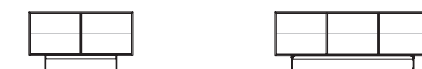

Design:
Luca Roccadadia

Madia con contenitore laccato, rivestimento ante in vetro bocciardato retroargento, cornice telaio in alluminio. Piedini in vetro o metallo, disponibili in due altezze.

Sideboard with lacquered container, back silver-plated bush-hammered glass door cladding, aluminium frame. Glass or metal feet, available in two heights.

PIEDINI FEET

Metallo - Metal



MT98 MT97

Cristallo - Glass



CR14

ANTE DOORS

Vetro bocciardato - Bush hammered glass



VB01 VB02

CASSONE FRAME

Laccati - Lacquers



X06 X17

X310 GRACE

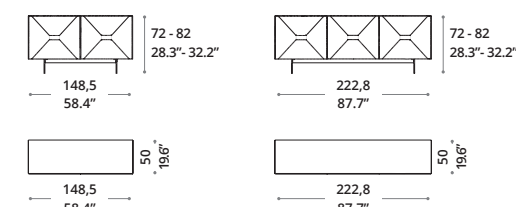

ripiani interni in vetro - glass inner shelves



Design:
Marco Pozzoli

Madia con contenitore laccato, rivestimento ante in cuoio con cuciture in tinta, cornice telaio in alluminio. Piedini in vetro o metallo, disponibili in due altezze.

Sideboard with lacquered container, leather doors with matching stitching, aluminium frame. Glass or metal feet, available in two heights.

PIEDINI FEET

Metallo - Metal



MT98 MT97

Cristallo - Glass



CR14

ANTE E FIANCHI DOORS AND SIDES

Cuoio - Leather



C10 C30 C25 C32 C18



C11 C09 C14 C31

CASSONE FRAME

Laccati - Lacquers



X06 X17

Madie

Sideboards

X308 PLANA

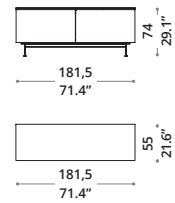

ripiani interni in vetro - glass inner shelves

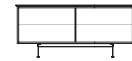

Design:
Studio Ozeta

Madia a due vani con ante, fianchi e piano in Marble Glass. Ripiani interni in cristallo e piedini in metallo verniciato.

Sideboard with two compartments with Marble Glass doors, sides and top. Internal glass shelves and painted metal feet.

PIEDINI FEET

Metallo - Metal



MT98

ANTE, FIANCHI E PIANO DOORS, SIDES AND TOP

Marble Glass



MG05 MG03 MG02 MG04

CASSONE FRAME

Laccati - Lacquers



X06

X314 RAIN

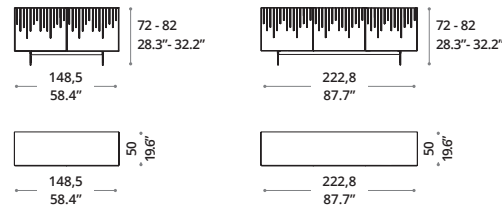

ripiani interni in vetro - glass inner shelves



Design:
Studio Ozeta - Luca Roccadadria

Madia con contenitore laccato, rivestimento ante con motivo a listelli in legno su fondo specchio, cornice telaio in alluminio. Piedini in vetro o metallo, disponibili in due altezze.

Sideboard with lacquered container, doors with wooden slat pattern on mirror bottom, aluminium frame. Glass or metal feet, available in two heights.



Piede: H. 10 o 20
Feet : H. 3.9" or 7.8"

PIEDINI FEET

Metallo - Metal



MT97

Cristallo - Glass



CR14

BACCHETTE STICKS

Legno - Wood



PZ51

ANTE DOORS

Cristallo - Glass



VS01

CASSONE FRAME

Laccati - Lacquers



X17

X315 RAIN WOOD

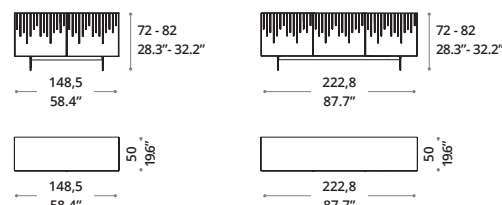

ripiani interni in vetro - glass inner shelves



Design:
Studio Ozeta - Luca Roccadadria

Madia con contenitore laccato, rivestimento ante con motivo a listelli in legno su fondo legno, cornice telaio in alluminio. Piedini in vetro o metallo, disponibili in due altezze.

Sideboard with lacquered container, doors with wooden slat pattern on wooden bottom, aluminium frame. Glass or metal feet, available in two height.



Piede: H. 10 o 20
Feet : H. 3.9" or 7.8"

PIEDINI FEET

Metallo - Metal



MT98 MT97

Cristallo - Glass



CR14

BACCHETTE STICKS

Legno - Wood



PZ51

ANTE DOORS

Legno - Wood



PZ51

CASSONE FRAME

Laccati - Lacquers



X06 X17

X313 SARAH

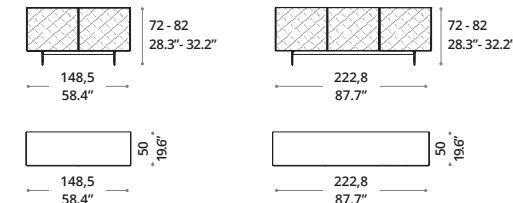

ripiani interni in vetro - glass inner shelves



Design:
Luca Roccadadria

Madia con contenitore laccato, rivestimento ante in specchio curvato, cornice telaio in alluminio. Piedini in vetro o metallo, disponibili in due altezze.

Sideboard with lacquered container, curved mirror door cladding, aluminium frame. Glass or metal feet, available in two heights.



Piede: H. 10 o 20
Feet : H. 3.9" or 7.8"

PIEDINI FEET

Metallo - Metal



MT98 MT97

Cristallo - Glass



CR14

ANTE DOORS

Cristallo - Glass



VS01 VS02

CASSONE FRAME

Laccati - Lacquers



X06 X17

X307 TRILOGY DUO

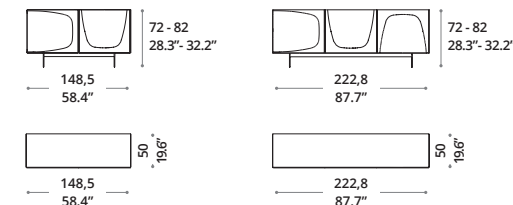

ripiani interni in vetro - glass inner shelves



Design:
Andrea Lucatello

Madia con contenitore laccato, rivestimento ante in pelle e cornice telaio in alluminio. Piedini in vetro o metallo, disponibili in due altezze.

Sideboard with lacquered container, soft leather door cladding and aluminium frame. Glass or metal feet, available in two heights.



Piede: H. 10 o 20
Feet : H. 3.9" or 7.8"

PIEDINI FEET

Metallo - Metal



MT98 MT97

Cristallo - Glass



CR14

ANTE DOORS

Pelle - Soft leather



P01 P19 P05 P11 P18



P04 P20 P90 P10 P02

CASSONE FRAME

Laccati - Lacquers



X06 X17

Sedute Chairs

S051 ATENA

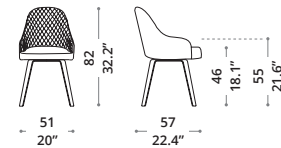

Design:
Studio Ozeta

Seduta con braccioli interamente rivestita in varie finiture, interno dello schienale trapuntato. Basamento in multistrato impiallacciato rovere.

Fully upholstered chair with armrests in various finishes, quilted backrest interior. Base in veneered oak plywood.

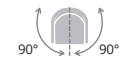

Rotazione con molla di ritorno
Return spring swivel

STRUTTURA STRUCTURE

Legno - Wood



SEDUTA SEAT

Velvet



Bouclè



Eco pelle nabuk - Soft eco leather nabuk



Pelle - Soft leather



S050 BETTA

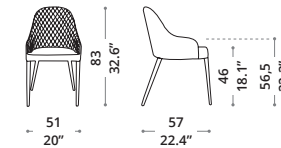

Design:
Studio Ozeta

Seduta con braccioli interamente rivestita in varie finiture. Interno dello schienale trapuntato.

Fully upholstered chair with armrests in various finishes. Quilted backrest interior.

SEDUTA E STRUTTURA SEAT AND STRUCTURE

Velvet

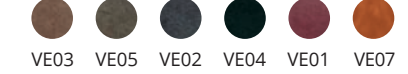

Bouclè



Eco pelle nabuk - Soft eco leather nabuk



Pelle - Soft leather



S012 BAIA

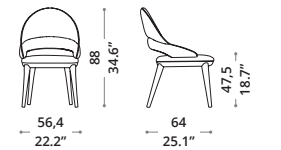

Design:
Andrea Lucatello

Seduta con schienale e sedile rivestiti in varie finiture. Struttura in massello di frassino spazzolato e tinto.

Chair with upholstered backrest and seat in various finishes. Structure in solid brushed and dyed ash.

STRUTTURA STRUCTURE

Legno - Wood



SEDUTA SEAT

Velvet



Bouclè



Eco pelle nabuk - Soft eco leather nabuk



Pelle - Soft leather



S321 BLITZ

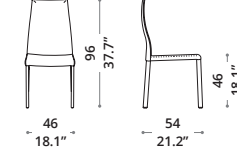

Design:
Studio Ozeta

Seduta completamente rivestita. Disponibile in tre differenti versioni: classica, cordoncino a contrasto e cuoio.

Fully upholstered chair. Available in three different versions; classic, contrasting drawstring and leather.

SEDUTA E STRUTTURA SEAT AND STRUCTURE

Velvet

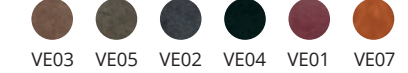

Eco pelle - Soft eco-leather



Eco pelle nabuk - Soft eco leather nabuk



Cuoio - Leather



Pelle - Soft leather



S463 BAIA BR

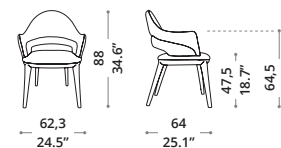

Design:
Andrea Lucatello

Seduta con braccioli, schienale e sedile rivestiti in varie finiture. Struttura in massello di frassino spazzolato e tinto.

Chair with upholstered armrests, backrest and seat in various finishes. Structure in solid brushed and dyed ash.

STRUTTURA STRUCTURE

Legno - Wood



SEDUTA SEAT

Velvet

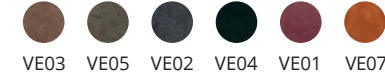

Bouclè



Eco pelle nabuk - Soft eco leather nabuk



Pelle - Soft leather



Sedute Chairs

S011 CUBIX

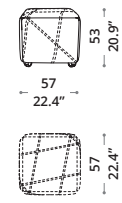

2 sedie piccole - 2 small chairs

schienale aperto
open backrest

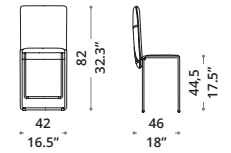

schienale chiuso
closed backrest

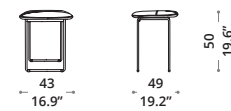

2 sedie grandi - 2 big chairs

schienale aperto
open backrest

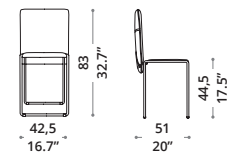

schienale chiuso
closed backrest

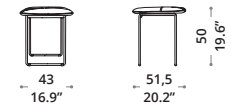

sgabello - stool

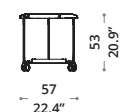

Design:
Giulio Manzoni

Pouf trasformabile dotato di quattro ruote per una facile movimentazione. Contiene al suo interno 4 sedie pieghevoli con seduta e poggia schiena imbottito.

Convertible ottoman equipped with four wheels for ease of movement. Inside, it contains 4 folding chairs with padded seat and backrest.



Dotato di rotelle
Equipped with castors

STRUTTURA STRUCTURE

Metallo - Metal



MT97

SEDUTA E SCHIENALE SEAT AND BACK

Velvet



Bouclè



Eco pelle - Soft eco-leather



Eco pelle nabuk - Soft eco leather nabuk (CRIB 5)



S052 DEMETRA

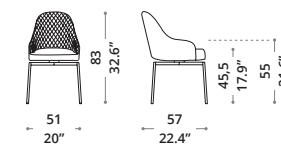

Design:
Studio Ozeta

Seduta con braccioli interamente rivestita, anche nella struttura, in varie finiture. Interno dello schienale trapuntato. Struttura girevole con molla di ritorno.

Chair with armrests, fully upholstered including in the structure, in various finishes. Quilted backrest interior. Swivel structure with return spring.

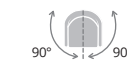

Rotazione con molla di ritorno
Return spring swivel

SEDUTA E SCHIENALE SEAT AND STRUCTURE

Velvet

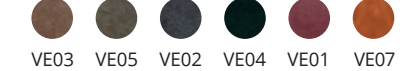

Eco pelle nabuk - Soft eco leather nabuk



Pelle - Soft leather



S022 EGO

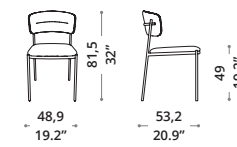

Design:
Davide Carlesi - Luca Tonelli

Seduta con schienale e sedile rivestiti in varie finiture. Struttura in metallo verniciato.

Chair with backrest and seat upholstered in various finishes. Painted metal structure.

STRUTTURA STRUCTURE

Metallo - Metal



MT16

SEDUTA E SCHIENALE SEAT AND BACK

Velvet



Bouclè



Eco pelle - Soft eco-leather



S453 DELIA

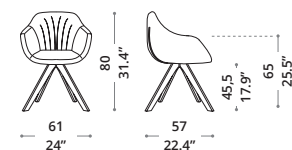

Design:
Studio Ozeta

Seduta con braccioli interamente rivestita in varie finiture. Struttura in faggio tinto.

Fully upholstered chair with armrests in various finishes. Dyed beech structure.

STRUTTURA STRUCTURE

Legno - Wood

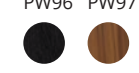
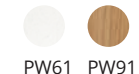

PW94 PZ51

SEDUTA SEAT

Velvet



Bouclè

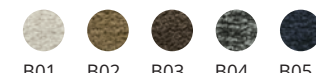

Eco pelle nabuk - Soft eco leather nabuk



Pelle - Soft leather



S062 EGO BR

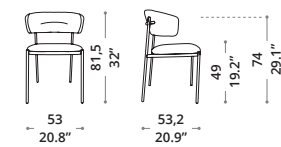

Design:
Davide Carlesi - Luca Tonelli

Seduta con braccioli, schienale e sedile rivestiti in varie finiture. Struttura in metallo verniciato.

Chair with armrests, backrest and seat upholstered in various finishes. Painted metal structure.

STRUTTURA STRUCTURE

Metallo - Metal



MT16

SEDUTA SEAT

Velvet

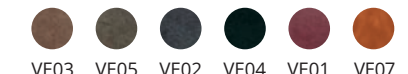

Bouclè



Eco pelle - Soft eco-leather



Sedute Chairs

S452 ELIOT

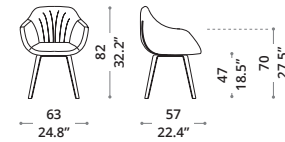

Design:
Studio Ozeta

Seduta con braccioli interamente rivestita in varie finiture. Basamento in multistrato impiallacciato rovere.

Fully upholstered chair with armrests in various finishes. Base in veneered oak plywood.

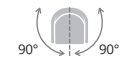

Rotazione con molla di ritorno
Return spring swivel

STRUTTURA STRUCTURE

Legno - Wood

PW61 PW91

PW96 PW97

PW94 PZ51

SEDUTA SEAT

Velvet

VE03 VE05 VE02 VE04 VE01 VE07

Bouclè

B01 B02 B03 B04 B05

B01 B02 B03 B04 B05

B01 B02 B03 B04 B05

Eco pelle nabuk - Soft eco leather nabuk

EP56 EP57 EP51 EP52 EP54 EP55 EP50

EP56 EP57 EP51 EP52 EP54 EP55 EP50

EP56 EP57 EP51 EP52 EP54 EP55 EP50

EP56 EP57 EP51 EP52 EP54 EP55 EP50

EP56 EP57 EP51 EP52 EP54 EP55 EP50

EP56 EP57 EP51 EP52 EP54 EP55 EP50

EP56 EP57 EP51 EP52 EP54 EP55 EP50

EP56 EP57 EP51 EP52 EP54 EP55 EP50

EP56 EP57 EP51 EP52 EP54 EP55 EP50

EP56 EP57 EP51 EP52 EP54 EP55 EP50

EP56 EP57 EP51 EP52 EP54 EP55 EP50

EP56 EP57 EP51 EP52 EP54 EP55 EP50

EP56 EP57 EP51 EP52 EP54 EP55 EP50

EP56 EP57 EP51 EP52 EP54 EP55 EP50

EP56 EP57 EP51 EP52 EP54 EP55 EP50

EP56 EP57 EP51 EP52 EP54 EP55 EP50

EP56 EP57 EP51 EP52 EP54 EP55 EP50

EP56 EP57 EP51 EP52 EP54 EP55 EP50

EP56 EP57 EP51 EP52 EP54 EP55 EP50

EP56 EP57 EP51 EP52 EP54 EP55 EP50

EP56 EP57 EP51 EP52 EP54 EP55 EP50

EP56 EP57 EP51 EP52 EP54 EP55 EP50

EP56 EP57 EP51 EP52 EP54 EP55 EP50

EP56 EP57 EP51 EP52 EP54 EP55 EP50

EP56 EP57 EP51 EP52 EP54 EP55 EP50

EP56 EP57 EP51 EP52 EP54 EP55 EP50

EP56 EP57 EP51 EP52 EP54 EP55 EP50

EP56 EP57 EP51 EP52 EP54 EP55 EP50

EP56 EP57 EP51 EP52 EP54 EP55 EP50

EP56 EP57 EP51 EP52 EP54 EP55 EP50

EP56 EP57 EP51 EP52 EP54 EP55 EP50

EP56 EP57 EP51 EP52 EP54 EP55 EP50

EP56 EP57 EP51 EP52 EP54 EP55 EP50

EP56 EP57 EP51 EP52 EP54 EP55 EP50

EP56 EP57 EP51 EP52 EP54 EP55 EP50

S448 GAVIA

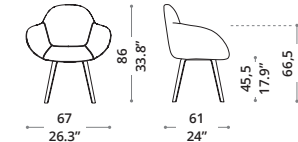

Design:
Studio Ozeta

Seduta con braccioli interamente rivestita in varie finiture. Basamento in multistrato impiallacciato rovere.

Fully upholstered chair with armrests in various finishes. Base in veneered oak plywood.

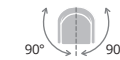

Rotazione con molla di ritorno
Return spring swivel

STRUTTURA STRUCTURE

Legno - Wood

PW61 PW91

PW96 PW97

PW94 PZ51

SEDUTA SEAT

Velvet

VE03 VE05 VE02 VE04 VE01 VE07

Bouclè

B01 B02 B03 B04 B05

B01 B02 B03 B04 B05

B01 B02 B03 B04 B05

Eco pelle nabuk - Soft eco leather nabuk

EP56 EP57 EP51 EP52 EP54 EP55 EP50

EP56 EP57 EP51 EP52 EP54 EP55 EP50

EP56 EP57 EP51 EP52 EP54 EP55 EP50

EP56 EP57 EP51 EP52 EP54 EP55 EP50

EP56 EP57 EP51 EP52 EP54 EP55 EP50

EP56 EP57 EP51 EP52 EP54 EP55 EP50

EP56 EP57 EP51 EP52 EP54 EP55 EP50

EP56 EP57 EP51 EP52 EP54 EP55 EP50

EP56 EP57 EP51 EP52 EP54 EP55 EP50

EP56 EP57 EP51 EP52 EP54 EP55 EP50

EP56 EP57 EP51 EP52 EP54 EP55 EP50

EP56 EP57 EP51 EP52 EP54 EP55 EP50

EP56 EP57 EP51 EP52 EP54 EP55 EP50

EP56 EP57 EP51 EP52 EP54 EP55 EP50

EP56 EP57 EP51 EP52 EP54 EP55 EP50

EP56 EP57 EP51 EP52 EP54 EP55 EP50

EP56 EP57 EP51 EP52 EP54 EP55 EP50

EP56 EP57 EP51 EP52 EP54 EP55 EP50

EP56 EP57 EP51 EP52 EP54 EP55 EP50

EP56 EP57 EP51 EP52 EP54 EP55 EP50

EP56 EP57 EP51 EP52 EP54 EP55 EP50

EP56 EP57 EP51 EP52 EP54 EP55 EP50

EP56 EP57 EP51 EP52 EP54 EP55 EP50

EP56 EP57 EP51 EP52 EP54 EP55 EP50

EP56 EP57 EP51 EP52 EP54 EP55 EP50

EP56 EP57 EP51 EP52 EP54 EP55 EP50

EP56 EP57 EP51 EP52 EP54 EP55 EP50

EP56 EP57 EP51 EP52 EP54 EP55 EP50

EP56 EP57 EP51 EP52 EP54 EP55 EP50

EP56 EP57 EP51 EP52 EP54 EP55 EP50

EP56 EP57 EP51 EP52 EP54 EP55 EP50

EP56 EP57 EP51 EP52 EP54 EP55 EP50

EP56 EP57 EP51 EP52 EP54 EP55 EP50

EP56 EP57 EP51 EP52 EP54 EP55 EP50

EP56 EP57 EP51 EP52 EP54 EP55 EP50

S447 FIONA

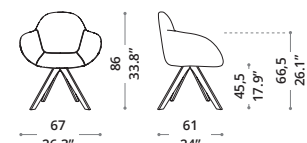

Design:
Studio Ozeta

Seduta con braccioli interamente rivestita in varie finiture. Struttura in faggio tinto.

Fully upholstered chair with armrests in various finishes. Dyed beech structure.

STRUTTURA STRUCTURE

Legno - Wood

PW61 PW91

PW96 PW97

PW94 PZ51

SEDUTA SEAT

Velvet

VE03 VE05 VE02 VE04 VE01 VE07

Bouclè

B01 B02 B03 B04 B05

B01 B02 B03 B04 B05

B01 B02 B03 B04 B05

Eco pelle nabuk - Soft eco leather nabuk

EP56 EP57 EP51 EP52 EP54 EP55 EP50

EP56 EP57 EP51 EP52 EP54 EP55 EP50

EP56 EP57 EP51 EP52 EP54 EP55 EP50

EP56 EP57 EP51 EP52 EP54 EP55 EP50

EP56 EP57 EP51 EP52 EP54 EP55 EP50

EP56 EP57 EP51 EP52 EP54 EP55 EP50

EP56 EP57 EP51 EP52 EP54 EP55 EP50

EP56 EP57 EP51 EP52 EP54 EP55 EP50

EP56 EP57 EP51 EP52 EP54 EP55 EP50

EP56 EP57 EP51 EP52 EP54 EP55 EP50

EP56 EP57 EP51 EP52 EP54 EP55 EP50

EP56 EP57 EP51 EP52 EP54 EP55 EP50

EP56 EP57 EP51 EP52 EP54 EP55 EP50

EP56 EP57 EP51 EP52 EP54 EP55 EP50

EP56 EP57 EP51 EP52 EP54 EP55 EP50

EP56 EP57 EP51 EP52 EP54 EP55 EP50

EP56 EP57 EP51 EP52 EP54 EP55 EP50

EP56 EP57 EP51 EP52 EP54 EP55 EP50

EP56 EP57 EP51 EP52 EP54 EP55 EP50

EP56 EP57 EP51 EP52 EP54 EP55 EP50

EP56 EP57 EP51 EP52 EP54 EP55 EP50

S461 GILDA

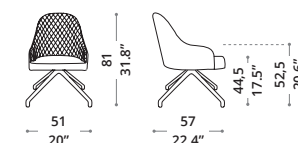

Design:
Studio Ozeta

Seduta con braccioli interamente rivestita in varie finiture, interno dello schienale trapuntato. Struttura girevole in metallo verniciato.

Fully upholstered chair with armrests in various finishes, quilted backrest interior. Swivel structure in painted metal.



Girevole a 360°
360° swivel

STRUTTURA STRUCTURE

Metallo - Metal

MT98 MT97

SEDUTA SEAT

Velvet

VE03 VE05 VE02 VE04 VE01 VE07

Bouclè

B01 B02 B03 B04 B05

B01 B02 B03 B04 B05

B01 B02 B03 B04 B05

Eco pelle nabuk - Soft eco leather nabuk

EP56 EP57 EP51 EP52 EP54 EP55 EP50

EP56 EP57 EP51 EP52 EP54 EP55 EP50

EP56 EP57 EP51 EP52 EP54 EP55 EP50

EP56 EP57 EP51 EP52 EP54 EP55 EP50

EP56 EP57 EP51 EP52 EP54 EP55 EP50

EP56 EP57 EP51 EP52 EP54 EP55 EP50

EP56 EP57 EP51 EP52 EP54 EP55 EP50

EP56 EP57 EP51 EP52 EP54 EP55 EP50

EP56 EP57 EP51 EP52 EP54 EP55 EP50

EP56 EP57 EP51 EP52 EP54 EP55 EP50

EP56 EP57 EP51 EP52 EP54 EP55 EP50

EP56 EP57 EP51 EP52 EP54 EP55 EP50

EP56 EP57 EP51 EP52 EP54 EP55 EP50

EP56 EP57 EP51 EP52 EP54 EP55 EP50

EP56 EP57 EP51 EP52 EP54 EP55 EP50

EP56 EP57 EP51 EP52 EP54 EP55 EP50

EP56 EP57 EP51 EP52 EP54 EP55 EP50

EP56 EP57 EP51 EP52 EP54 EP55 EP50

EP56 EP57 EP51 EP52 EP54 EP55 EP50

EP56 EP57 EP51 EP52 EP54 EP55 EP50

EP56 EP57 EP51 EP52 EP54 EP55 EP50

S341 FRISBEE



Design:
Studio Ozeta - Marco Pozzoli

Seduta completamente rivestita in cuoio con cuciture in tinta.

Fully leather-upholstered chair with matching stitching.

SEDUTA E STRUTTURA SEAT AND STRUCTURE

Cuoio - Leather

C10 C30 C25 C32 C18 C11 C09 C14 C31

C10 C30 C25 C32 C18 C11 C09 C14 C31

C10 C30 C25 C32 C18 C11 C09 C14 C31

C10 C30 C25 C32 C18 C11 C09 C14 C31

C10 C30 C25 C32 C18 C11 C09 C14 C31

C10 C30 C25 C32 C18 C11 C09 C14 C31

C10 C30 C25 C32 C18 C11 C09 C14 C31

C10 C30 C25 C32 C18 C11 C09 C14 C31

C10 C30 C25 C32 C18 C11 C09 C14 C31

C10 C30 C25 C32 C18 C11 C09 C14 C31

C10 C30 C25 C32 C18 C11 C09 C14 C31

C10 C30 C25 C32 C18 C11 C09 C14 C31

S010 GIOTTO

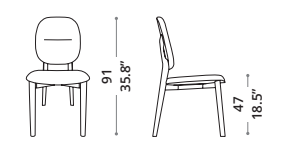

Design:
Andrea Lucatello

Seduta con schienale e sedile rivestiti in varie finiture. Struttura in frassino tinto.

Chair with upholstered backrest and seat in various finishes. Structure in dyed ash.

STRUTTURA STRUCTURE

Legno - Wood

PW61 PW91

PW96 PW97

PW94

SEDUTA SEAT

Bouclè

B01 B02 B03 B04 B05

B01 B02 B03 B04 B05

B01 B02 B03 B04 B05

B0

Sedute Chairs

S462 HALIA

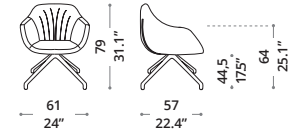

Design:
Studio Ozeta

Seduta con braccioli interamente rivestita in varie finiture. Struttura girevole in metallo verniciato.

Fully upholstered chair with armrests in various finishes. Swivel structure in painted metal.



Girevole a 360°
360° swivel

STRUTTURA STRUCTURE

Metallo - Metal

MT98 MT97

SEDUTA SEAT

Velvet

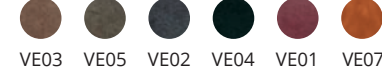

Bouclè



Eco pelle nabuk - Soft eco leather nabuk



Pelle - Soft leather



S013 JULIETTE

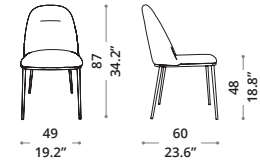

Design:
Marco Pozzoli

Seduta con schienale e sedile rivestiti in varie finiture. Struttura in metallo verniciato.

Chair with upholstered backrest and seat in various finishes. Painted metal structure.

STRUTTURA STRUCTURE

Metallo - Metal

MT98 MT97

MT16

SEDUTA SEAT

Eco pelle - Soft eco-leather



Bouclè



S336 KITE

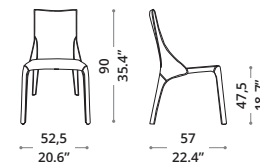

Design:
Andrea Lucatello

Seduta completamente rivestita in cuoio, cuciture in tinta.

Fully upholstered leather chair, matching stitching.

SEDUTA E STRUTTURA SEAT AND STRUCTURE

Cuoio - Leather



S337 LOREN

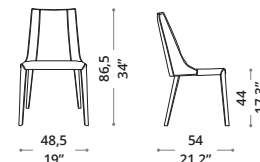

Design:
Studio Ozeta

Seduta completamente rivestita in cuoio, cuciture in tinta.

Fully upholstered leather chair, matching stitching.

SEDUTA E STRUTTURA SEAT AND STRUCTURE

Cuoio - Leather



S322 LUNETTE

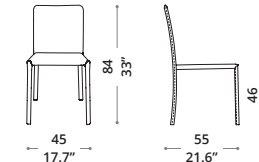

Design:
Studio Ozeta

Seduta completamente rivestita in varie finiture.

Fully upholstered chair in various finishes.

SEDUTA E STRUTTURA SEAT AND STRUCTURE

Cuoio - Leather



Pelle - Soft leather



S314 MEGAN

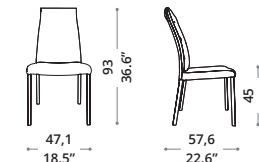

Design:
Studio Ozeta

Seduta completamente rivestita in pelle.

Fully upholstered chair in soft leather.

SEDUTA E STRUTTURA SEAT AND STRUCTURE

Pelle - Soft leather



S450 NELSON

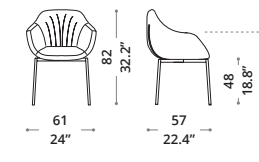

Design:
Studio Ozeta

Seduta con braccioli interamente rivestita, anche nella struttura, in varie finiture. Struttura girevole con molla di ritorno.

Chair with armrests, fully upholstered including in the structure, in various finishes. Swivel structure with return spring.

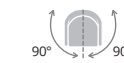

Rotazione con molla di ritorno
Return spring swivel

SEDUTA E STRUTTURA SEAT AND STRUCTURE

Velvet

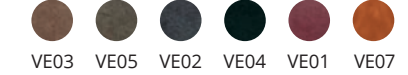

Eco pelle nabuk - Soft eco leather nabuk

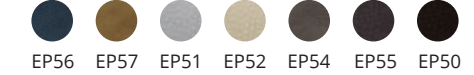

Pelle - Soft leather

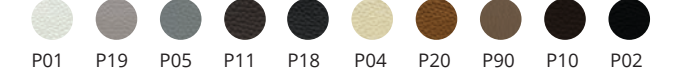

S318 NEXUS

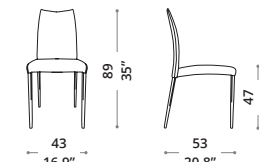

Design:
Studio Ozeta

Seduta completamente rivestita in varie finiture. Basamento in metallo verniciato.

Fully upholstered chair in various finishes. Painted metal base.

STRUTTURA STRUCTURE

Metallo - Metal

MT98

SEDUTA SEAT

Eco pelle - Soft eco-leather

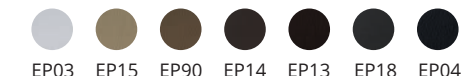

Eco pelle nabuk - Soft eco leather nabuk



Sedute Chairs

S053 OLIMPIA

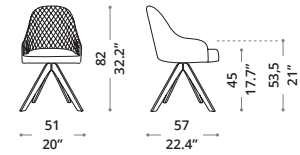

Design:
Studio Ozeta

Seduta con braccioli interamente rivestita in varie finiture, interno dello schienale trapuntato. Struttura in faggio tinto.

Fully upholstered chair with armrests in various finishes, quilted backrest interior. Dyed beech structure.

STRUTTURA STRUCTURE

Legno - Wood

PW61 PW91

PW96 PW97

PW94 PZ51

SEDUTA SEAT

Velvet

VE03 VE05 VE02 VE04 VE01 VE07

Bouclè

B01 B02 B03 B04 B05

Eco pelle nabuk - Soft eco leather nabuk

EP56 EP57 EP51 EP52 EP54 EP55 EP50

Pelle - Soft leather

P01 P19 P05 P11 P18 P04 P20 P90 P10 P02

P01 P19 P05 P11 P18 P04 P20 P90 P10 P02

P01 P19 P05 P11 P18 P04 P20 P90 P10 P02

P01 P19 P05 P11 P18 P04 P20 P90 P10 P02

P01 P19 P05 P11 P18 P04 P20 P90 P10 P02

S208 PLIO

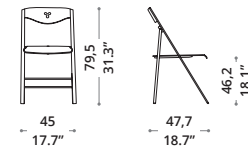

Design:
Marco Pozzoli
& Studio Ozeta

Seduta pieghevole con struttura in metallo, sedile e schienale in materiale plastico.

Folding chair with metal structure, seat and back in plastic material.

STRUTTURA STRUCTURE

Metallo - Metal

MT91 MT98

MT97

SEDUTA E SCHIENALE SEAT AND BACK

Polipropilene - Polypropylene

PL01 PL08 PL18

S215 RIPIEGO

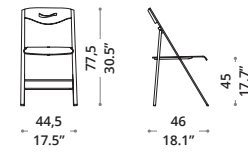

Design:
Giuliano Cappelletti
& Studio Ozeta

Sedia pieghevole con struttura in metallo, sedile e schienale in legno.

Folding chair with metal frame, seat and back in wood.

STRUTTURA STRUCTURE

Metallo - Metal

MT91 MT98

MT97

SEDUTA E SCHIENALE SEAT AND BACK

Legno - Wood

PW61 PW91 PW96 PW97 PW94

S058 SALLY

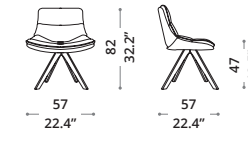

Design:
Marco Pozzoli

Seduta interamente rivestita in varie finiture. Struttura in faggio tinto.

Fully upholstered chair in various finishes. Dyed beech structure.

STRUTTURA STRUCTURE

Legno - Wood

PW61 PW91

PW96 PW97

PW94 PZ51

SEDUTA SEAT

Velvet

VE03 VE05 VE02 VE04 VE01 VE07

Bouclè

B01 B02 B03 B04 B05

Pelle - Soft leather

P01 P19 P05 P11 P18 P04 P20 P90 P10 P02

P01 P19 P05 P11 P18 P04 P20 P90 P10 P02

P01 P19 P05 P11 P18 P04 P20 P90 P10 P02

P01 P19 P05 P11 P18 P04 P20 P90 P10 P02

P01 P19 P05 P11 P18 P04 P20 P90 P10 P02

S060 SELENA

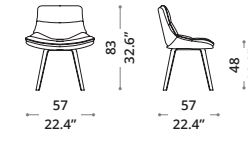

Design:
Marco Pozzoli

Seduta interamente rivestita in varie finiture. Basamento in multistrato impiallacciato rovere.

Fully upholstered chair in various finishes. Base in veneered oak plywood.

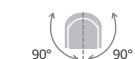

Rotazione con molla di ritorno
Return spring swivel

STRUTTURA STRUCTURE

Legno - Wood

PW61 PW91

PW96 PW97

PW94 PZ51

SEDUTA SEAT

Velvet

VE03 VE05 VE02 VE04 VE01 VE07

Bouclè

B01 B02 B03 B04 B05

Pelle - Soft leather

P01 P19 P05 P11 P18 P04 P20 P90 P10 P02

P01 P19 P05 P11 P18 P04 P20 P90 P10 P02

P01 P19 P05 P11 P18 P04 P20 P90 P10 P02

P01 P19 P05 P11 P18 P04 P20 P90 P10 P02

S061 SIRIA

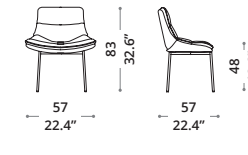

Design:
Marco Pozzoli

Seduta interamente rivestita, anche nella struttura, in varie finiture. Struttura girevole con molla di ritorno.

Fully upholstered chair, including in the structure, in various finishes. Swivel structure with return spring.

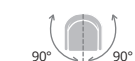

Rotazione con molla di ritorno
Return spring swivel

SEDUTA E STRUTTURA SEAT AND STRUCTURE

Velvet

VE03 VE05 VE02 VE04 VE01 VE07

Pelle - Soft leather

P01 P19 P05 P11 P18 P04 P20 P90 P10 P02

P01 P19 P05 P11 P18 P04 P20 P90 P10 P02

P01 P19 P05 P11 P18 P04 P20 P90 P10 P02

P01 P19 P05 P11 P18 P04 P20 P90 P10 P02

Sedute Chairs

S316 SOFIA

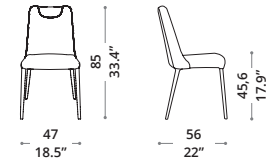

Design:
Studio Ozeta

Seduta completamente rivestita in varie finiture.

Fully upholstered chair in various finishes.

SEDUTA E STRUTTURA SEAT AND STRUCTURE

Bouclè



Eco pelle - Soft eco-leather



Pelle - Soft leather



S059 SVEVA

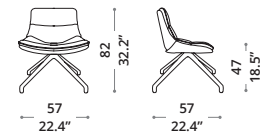

Design:
Marco Pozzoli

Seduta interamente rivestita in varie finiture. Struttura girevole in metallo verniciato.

Fully upholstered chair in various finishes. Swivel structure in painted metal.



Girevole a 360°
360° swivel

STRUTTURA STRUCTURE

Metallo - Metal



SEDUTA SEAT

Velvet

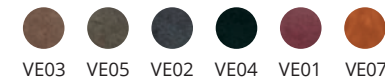

Bouclè



Pelle - Soft leather



S449 TEN

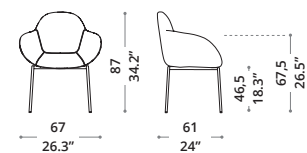

Design:
Studio Ozeta

Seduta con braccioli interamente rivestita, anche nella struttura, in varie finiture. Struttura girevole con molla di ritorno.

Chair with armrests, fully upholstered including in the structure, in various finishes. Swivel structure with return spring.

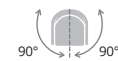

Rotazione con molla di ritorno
Return spring swivel

SEDUTA E STRUTTURA SEAT AND STRUCTURE

Velvet



Eco pelle nabuk - Soft eco leather nabuk



Pelle - Soft leather



S456 THELMA

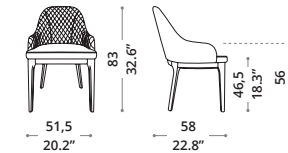

Design:
Studio Ozeta

Seduta con braccioli completamente rivestita in varie finiture, Interno dello schienale trapuntato. Basamento in massello di frassino spazzolato e seduta.

Fully upholstered chair with armrests in various finishes, quilted backrest interior. Solid brushed ash base and seat.

STRUTTURA STRUCTURE

Legno - Wood

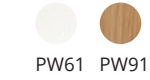

SEDUTA SEAT

Velvet

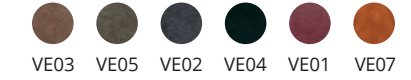

Bouclè



Eco pelle nabuk - Soft eco leather nabuk



Pelle - Soft leather



S330 VIVA

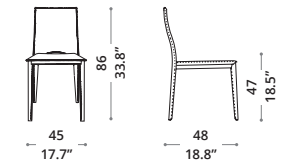

Design:
Toshiyuki Yoshino & Studio Ozeta

Seduta completamente rivestita in cuoio, cuciture in tinta.

Fully upholstered leather chair, matching stitching.

SEDUTA E STRUTTURA SEAT AND STRUCTURE

Cuoio - Leather



S460 ZELDA

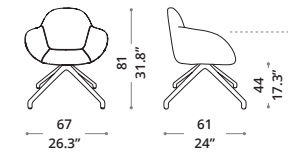

Design:
Studio Ozeta

Seduta con braccioli interamente rivestita in varie finiture. Struttura girevole in metallo verniciato.

Fully upholstered chair with armrests in various finishes. Swivel structure in painted metal.



Girevole a 360°
360° swivel

STRUTTURA STRUCTURE

Metallo - Metal

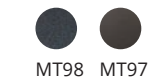

SEDUTA SEAT

Velvet



Bouclè



Eco pelle nabuk - Soft eco leather nabuk



Pelle - Soft leather



S464 ZICO

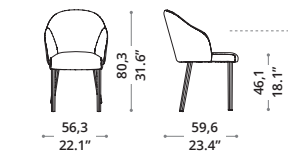

Design:
Studio Ozeta

Seduta con schienale e sedile rivestiti in varie finiture. Struttura in legno.

Chair with upholstered backrest and seat in various finishes. Wooden structure.

STRUTTURA STRUCTURE

Legno - Wood

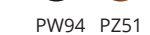
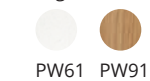

SEDUTA SEAT

Bouclè



Eco pelle nabuk - Soft eco leather nabuk



Finiture
Finishes

LEGNI
WOOD



PW61
Rovere wild bianco
Wild white oak



PW91
Rovere wild naturale
Wild natural oak



PW96
Rovere wild delhi
Wild delhi oak



PW97
Rovere wild tabacco
Wild tabacco oak



PW94
Rovere wild carbone
Wild carbone oak



PZ93
Rovere vecchio soft
Soft ancient oak



PZ91
Rovere vecchio naturale
Natural ancient oak



PZ94
Rovere vecchio dark grey
Dark grey ancient oak



PZ51
Noce canaletto
Canaletto walnut

ECO LEGNO
ECO WOOD



ML52
Bianco spatolato
Spalted white



ML39
Beton
Beton



ML50
Pietra
Stone



ML92
Vecchio antico
Ancient old



ML44
Carbone
Carbone



ML43
Noce canaletto
Canaletto walnut



ML45
Rovere grigio
Grey oak

CEMENTI
CEMENTS



CM61
Grigio
Grey

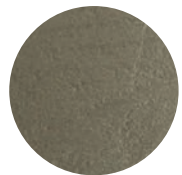

CM90
Tortora
Tortora

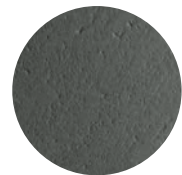

CM98
Grafite
Graphite



CM62
Terra
Terra

CRISTALLO
GLASS



CR14
Trasparente
Transparent

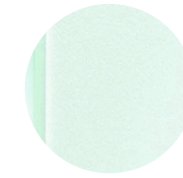

CR17
Float
Float

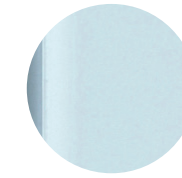

CR01
Extrachiaro
Extrawhite



CR16
Crema caffè
Coffee cream



CR04
Antracite
Anthracite



CR08
Nero
Black

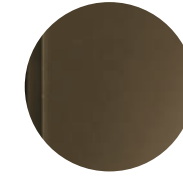

CR21
Bronzo
Bronze

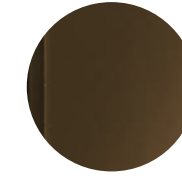

VS01
Specchio bronze
Bronze mirror



VS02
Specchio fumè
Fumè mirror

ANTIMPRONTA | MARK-LESS

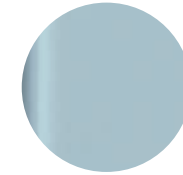

CR09
Antimpronta bianco
Mark-less white



CR19
Antimpronta crema caffè
Mark-less coffee cream

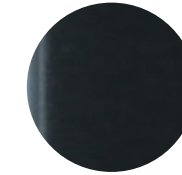

CR18
Antimpronta grafite
Mark-less graphite

VETRO
BOCCIARDATO
BUSH HAMMERED
GLASS

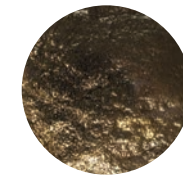

VB01
Bronzo silver
Bronze silver



VB02
Fumè silver
Fumè silver

CRISTALLO BORO
BORO GLASS



CR14
Trasparente
Transparent

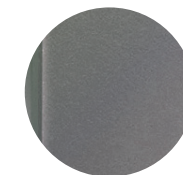

CR22
Fumè Iri
Fumè Iri

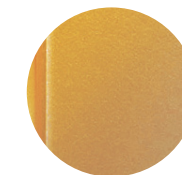

CR20
Ambra Iri
Ambra Iri

MARBLE GLASS

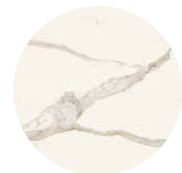

MG05
Calacatta gold lucido
Glossy Calacatta gold



MG03
Onice lucido
Glossy onice



MG02
Sahara noir lucido
Glossy Sahara noir

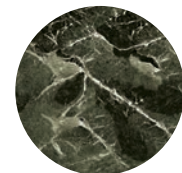

MG04
Verde Alpi lucido
Glossy verde Alpi

CERAMICA
PYROCERAM



CC07
Calacatta
Calacatta



CC11
Gold beauty
Gold beauty

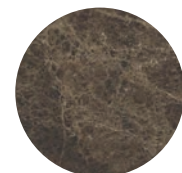

CC10
Emperador
Emperador



CC08
Noir desir
Noir desir

LACCATI
LACQUERS



X01
Inverno
Inverno

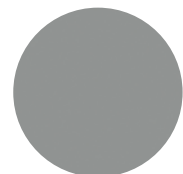

X02
Pomice
Pomice

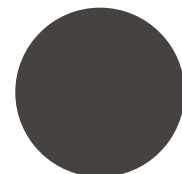

X06
Ardesia
Ardesia

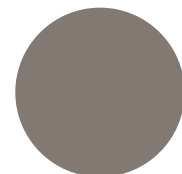

X03
Cemento
Cemento

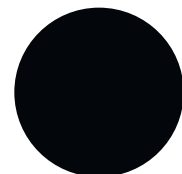

X04
Nero
Black



X16
Champagne
Champagne



X17
Bronzo
Bronze

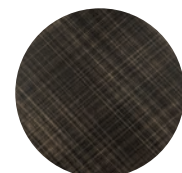

X18
Bronzo Seta
Silk bronze



X19
Avorio
Ivory

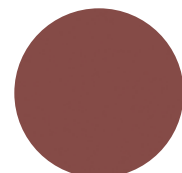

X20
Granata
Garnet

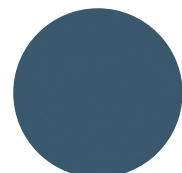

X07
Avio
Avio

VELVET
VELVET



VE03
Castoro
Beaver

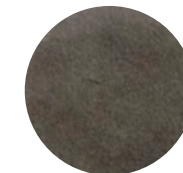

VE05
Corda
Rope

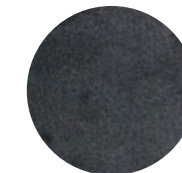

VE02
Grigio
Grey



VE04
Smeraldo
Emerald



VE01
Rosa
Pink

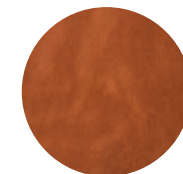

VE07
Ruggine
Rust

BOUCLÈ
BOUCLÈ



B01
Burro
Butter

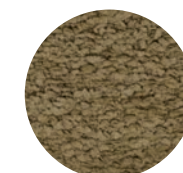

B02
Liquirizia
Liquorice



B03
Bruno
Dark Brown

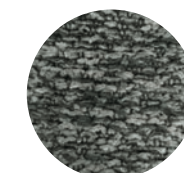

B04
Basalto
Basalt

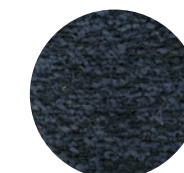

B05
Blu oltremare
Ultramarine blue

CUOIO
LEATHER



C10
Bianco
White

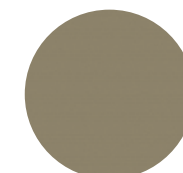

C30
Crema caffè
Coffee cream



C25
Seta grigia
Grey silk



C32
Piombo
Piombo

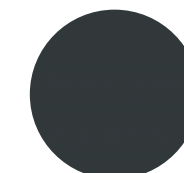

C18
Grafite
Graphite

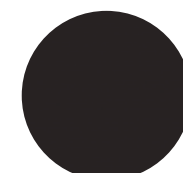

C11
Moka
Moka

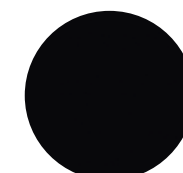

C09
Nero
Black

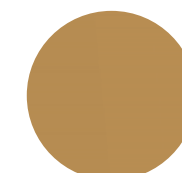

C14
Naturale
Natural

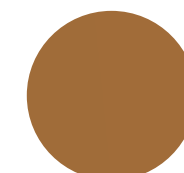

C31
Khaki
Khaki

ECO PELLE
SOFT ECO LEATHER



EP03
Bianco
White



EP15
Crema caffè
Coffee cream

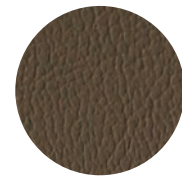

EP90
Fango
Fango



EP14
Mastice
Mastice



EP13
Moka
Moka



EP18
Grafite
Graphite



EP04
Nero
Black

NABUK | NABUK

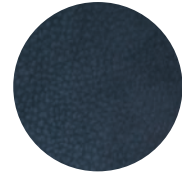

EP56
Nabuk blu
Nabuk blue



EP57
Nabuk lince
Nabuk lynce

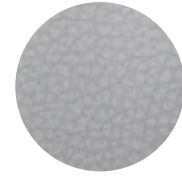

EP51
Nabuk bianco
Nabuk white



EP52
Nabuk crema caffè
Nabuk coffee cream

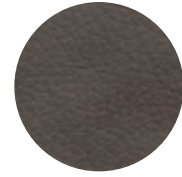

EP54
Nabuk ghiaccio
Nabuk ice

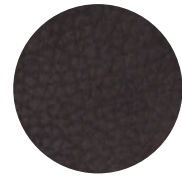

EP50
Nabuk grigio
Nabuk grey



EP55
Nabuk moka
Nabuk moka

PELLE
SOFT LEATHER



P01
Bianco
White



P19
Polvere
Polvere

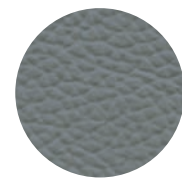

P05
Cenere
Ash



P11
Mastice
Mastice



P18
Grafite
Graphite



P04
Ecrú
Ecrú



P20
Havana
Havana

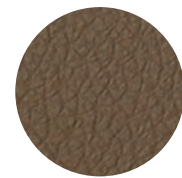

P90
Fango
Fango



P10
Moka
Moka



P02
Nero
Black

POLIPROPILENE
POLYPROPYLENE

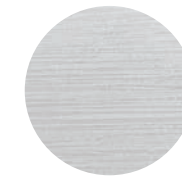

PL01
Bianco
White



PL08
Bronzo
Bronze

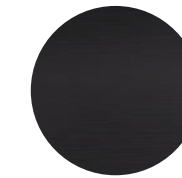

PL18
Grafite
Graphite

METALLI
METALS

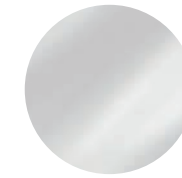

MT61
Bianco lucido
High gloss white

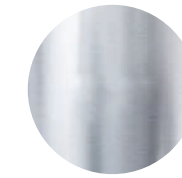

MT92
Cromo
Chrome



MT98
Grafite opaco
Matt graphite



MT16
Champagne
Champagne

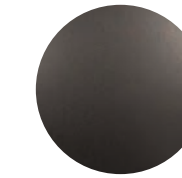

MT97
Bronzo
Bronze

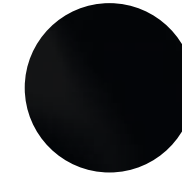

MT12
Nero opaco
Matt black

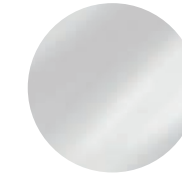

MT91
Bianco opaco
Matt white



Concept & A.D.: Arch. Lara Santin
Images: Nerokubo
Progetto grafico: Monica Ferretti - Intodesign
Stampa: Grafiche Antiga



POZZOLI GROUP srl licenziataria del marchio OZZIO ITALIA si riserva il diritto di apportare, senza preavviso, ogni modifica volta al miglioramento funzionale e qualitativo dei prodotti. Le informazioni e i disegni rappresentati in questo catalogo, oltre ad avere carattere puramente illustrativo sono suscettibili di variazioni. I campioni di colori e materiali presentati in questo stampato hanno un valore indicativo compatibilmente con i limiti di riproduzione e stampa.

© PROPRIETÀ DI POZZOLI GROUP srl - TUTTI I DIRITTI RISERVATI - I marchi e gli altri segni distintivi, i testi, le fotografie, i disegni ed i modelli, i prodotti e gli altri materiali riportati nella presente brochure e tutti i diritti di proprietà intellettuale ed industriale ad essi relativi costituiscono proprietà riservata di POZZOLI GROUP srl. È vietata la loro riproduzione, copia, imitazione, pubblicazione, diffusione, distribuzione, elaborazione e qualsiasi uso, anche parziale, nella pubblicità, sui prodotti, confezioni, materiali illustrativi o pubblicitari, siti internet, nelle attività di marketing e commerciali ed ogni altro uso, senza la preventiva autorizzazione scritta di POZZOLI GROUP srl.

OZZIO ITALIA brand of POZZOLI GROUP srl reserves the right to change, without notice, any modification to the improvement functional and quality of the products. The information and drawings in this catalog, as well as have purely illustrative are subject to change. Samples of colors and materials presented in this publication are indicative consistent with the limitations of reproduction and printing.

© PROPERTIES OF POZZOLI GROUP srl - ALL RIGHTS RESERVED - Trademarks and other distinctive signs, texts, photographs, drawings and models, products and other materials contained in this brochure and all the intellectual and industrial property rights relating thereto are copyrighted by POZZOLI GROUP srl. And forbidden their reproduction, copying, imitation, publication, dissemination, distribution, processing and use, even partial, advertising, products, packaging, artworks or advertising, websites, marketing activities and sales and all other use without the prior written permission of POZZOLI GROUP srl.

OZZIO[®] ITALIA

POZZOLI GROUP srl

Via Brughetti 17
20813 Bovisio Masciago (MB)
Italy

t. +39 0362 59701
ozzio@ozzio.com
www.ozzio.com