

## Trasformabili

Transformable

Trasformabili - Consolle - Multifunzione  
Transformable - Console - Multifunctional

Tavolini trasformabili, tavolini da caffè elevabili e consolle sono solo alcuni dei prodotti della collezione OZZIO ITALIA, essi nascondono a occhi non allenati la loro poliedricità. In questa raccolta fotografica possiamo trovare consolle minimal e discrete o scultoree e percettibili, che presentano ingombri estremamente limitati da chiuse, ma capaci di estendersi sorprendentemente arrivando ad ospitare fino a 14 commensali.

I tavolini multifunzione sfoggiano piani che si alzano ed estendono in avanti a supporto delle più disparate attività di vita quotidiana, come lavorare con un notebook o laptop, pranzare, disegnare o organizzare uno spuntino in compagnia e giochi di società.

I tavolini trasformabili si alzano e trasformano in tavoli da pranzo, alcuni in grado di ospitare fino a 10 commensali. Regolabili in altezza al millimetro e meccanismi in alluminio, tutti provvisti di rotelle per una facile movimentazione anche attraverso diversi ambienti.

Transformable tables, multifunctional coffee tables and consoles are just some of the products in the OZZIO ITALIA collection, hiding their versatility from untrained eyes. In this photo collection we can find consoles that are minimal and discreet or sculptural and perceptible, that have extremely limited dimensions when closed, but are able to extend surprisingly to accommodate up to 14 diners.

Multifunctional coffee tables sport tops that lift up and extend forward to support the most diverse activities of daily life, such as working with a notebook or laptop, dining, drawing or organising a snack with friends and board games.

Transformable tables can be raised and transformed into dining tables, some able to seat up to 10 diners. Height adjustable to the millimetre and aluminium mechanisms, all fitted with castors for easy movement through different environments.

Consolle  
Consoles

Tavolini multifunzione  
Multifunctional coffee tables







Tavolini trasformabili  
Transformable tables

**OZZIO**<sup>®</sup> ITALIA





## 01. Company profile Company profile

La storia The story	6
Hand crafted Hand crafted	8
Finitura Cemento Cemento Finish	10
Partnership creativa Creative Partnership	14













## 02. Consolle Consoles

	prodotti products	scheda tecnica technical sheet
 T029 Minux	18	215
 T031 CO4L	26	214
 T024 4YOU	34	213
 T023 A3	42	213
 T021 A4	52	214
 T035 Golia	60	215



## 03. Tavolini multifunzione Multifunctional coffee tables

	prodotti products	scheda tecnica technical sheet
 T058 Zoom	70	218
 T059 Bell	78	216
 T061 Bellagio	84	216
 T067 Aurelius	92	216
 T063 Markus	100	217
 T062 Metrino	108	217
 T064 Radius	114	217

## 04. Tavolini trasformabili Transformable tables

	prodotti products	scheda tecnica technical sheet
 T132 Ellis	122	220
 T133 Jolly	130	220
 T101 Su e Giù	136	223
 T129 Leonardo	144	221
 T110 Box	152	219
 T111 Box legno	160	219
 T123 Newood	166	222
 T096 Mondial	174	221
 T097 Mondial CR	174	221
 T115 Planet	180	222
 T121 Sydney	188	223
 T128 Sydney CR	188	223

## 05. Sedute Seat

	prodotti products	scheda tecnica technical sheet
 S011 Cubix	196	224
 S215 Ripiego	202	225
 S208 Plio	206	224

## 06. Informazioni tecniche Technical information

Schede tecniche Technical sheets	212
Finiture Finishes	226





# La storia

The story

La storia di OZZIO ITALIA inizia nel 1961 nella culla di molte eccellenze dell'italian design: il distretto della Brianza a nord di Milano.

Nel primo laboratorio artigiano della famiglia Pozzoli si coltiva la qualità: con questa filosofia e un forte legame con il proprio territorio, l'azienda cresce fino a diventare oggi un brand internazionale, presente con i suoi prodotti in 5 continenti.

La collezione OZZIO ITALIA è contraddistinta da una particolare interpretazione della vita contemporanea, frutto di una visione in grado di raccogliere ispirazioni da tutto il mondo e trasformarle in proposte dall'inconfondibile stile italiano.

OZZIO ITALIA ha posto le basi del proprio sales network internazionale a partire dagli anni 90. Oggi l'azienda è una realtà di riferimento nell'ambito dell'arredamento multifunzione, con una consolidata presenza in Europa, America, Asia e Africa confermata da showroom istituzionali nelle più importanti città del mondo.

The history of OZZIO ITALIA started in 1961, in the cradle of many italian design excellences: the Brianza district, located north of Milano.

In the first artisan workshop of the Pozzoli Family, quality was the first value: with this philosophy and a strong bond with its homeland, the company grows until becoming, today, an international brand, currently available throughout five continents.

The OZZIO ITALIA collection is characterised by a particular interpretation of contemporary lifestyle, fruit of a vision that gathers inspiration from the whole world and transforms it in unmistakably italian design propositions.

OZZIO ITALIA laid its international sales network bases starting from the 90s. Today, the company is a reference reality in multi-functional furniture field, with a consolidated turnout in Europe, America, Asia and Africa, confirmed by the presence in the best showrooms in the most important cities of the world.

# Hand crafted

Hand crafted

Tecnologia ed artigianato dialogano insieme per produrre ciò che prima non c'era

Technology and craftsmanship working together to produce what was not there before

Dare risposte nuove agli stili e alle esigenze dell'abitare significa innanzitutto creare metodi per produrre ciò che prima non esisteva. Significa tradurre l'idea di un movimento in una realtà meccanica semplice e affidabile nel tempo. Significa creare i singoli componenti che rendono possibili le sorprendenti trasformazioni dei tavoli. Significa anche portare nel futuro una conoscenza antica di materiali come il legno e il metallo.

Le proposte OZZIO ITALIA sono così innovative che anche i metodi di produzione sono unici: un know-how esclusivo in cui la tecnologia dialoga con le radici di un laboratorio artigiano. Due aspetti che fanno parte della realtà quotidiana di tutti gli addetti altamente specializzati di OZZIO ITALIA, che curano con le proprie mani ogni dettaglio della collezione.

Giving new answer to the styles and needs of modern dwelling means, first of all, to create new ways of making what did not exist. It means to translate the idea of a movement in a mechanical reality, simple and reliable over time. It means to create the single components to make the amazing table transformations possible. It also means to bring along to the future an antique knowledge on materials like wood and metal.

The OZZIO ITALIA propositions are so innovative that also the production methods are unique: an exclusive knowhow where technology empathyzes with the roots of an artisan workshop. Two aspects, both part of every highlyskilled workers at OZZIO ITALIA, handcrafting every detail of the collection.



# Finitura Cemento

Cemento Finish

Una texture d'eccellenza, frutto di un lavoro artigianale unico nel suo genere

A texture of excellence, the result of unique artisanship

Molti dei prodotti presenti nella collezione OZZIO ITALIA sono realizzati con una particolare lavorazione, la simulazione del materiale Cemento.

Il Cemento, a differenza del classico materiale edilizio, può essere utilizzato e lavorato su piani e basi di tavoli e tavolini, con la garanzia di una resa altissima e praticità senza pari, non avendo al suo interno materiali nocivi, calce, gesso, leganti idraulici o resine epossidiche tossiche. Oltre che a un peso completamente conforme con l'utilizzo in ambito domestico.

OZZIO ITALIA presenta la finitura cemento in diverse tonalità naturali, essi si classificano distintivamente all'interno delle texture d'eccellenza delle collezioni, per il lavoro artigianale e unico nel suo genere.

Many of the products in the OZZIO ITALIA collection are made using a special process to create the material finish known as "Cemento".

Unlike classic building materials, Cemento can be used and worked with on the tops and bases of tables and coffee tables, with the guarantee of a very high yield and unparalleled practicality, as it does not contain any harmful materials, lime, plaster, hydraulic binders or toxic epoxy resins. In addition to a weight that is fully compliant with domestic use.

OZZIO ITALIA presents the Cemento finish in a variety of natural shades, distinctively classified within the collection's textures of excellence, for completely unique artisanship.



● T061 Bellagio  
tavolino multifunzione - multifunctional table  
CM62 CR14

Questa opera manifatturiera praticata da personale specializzato è costituita da una resina cementizia composta da una resina acrilica monocomponente all'acqua applicata a pannelli in fibra di legno truciolare o polverizzato, previa la preparazione di un fondo con stesura di isolanti poliuretanici opportunamente catalizzati, utili al fine di permettere una adesione uniforme dei materiali soprastanti.

L'applicazione del Cemento viene eseguita a mano da personale qualificato mediante spatolatura o pennellatura su piano, bordi e incavi che compongono gli elementi di diversi arredi, successivamente la lavorazione viene protetta con una finitura bicomponente ad alta resistenza. Tale lavorazione forma un film trasparente che protegge e valorizza l'aspetto dello spatolato effetto cemento, oltre che garantire igiene e durevolezza.

This work, carried out by specialised personnel, consists of a cementitious resin composed of a single-component, water-based acrylic resin applied to chipboard or pulverised wood fibre panels, after preparation of a base with the application of appropriately catalysed polyurethane insulators, suitable to ensure the uniform adhesion of the overlying materials.

The application of the Cemento is carried out by hand by qualified personnel by trowelling or brushing on tops, edges and recesses that make up the elements of various pieces of furniture, after which the work is protected with a high-strength, two-component finish. This process forms a transparent film that protects and enhances the appearance of the Cemento finish, as well as ensuring hygiene and durability.



L'artigiano che realizza il trattamento dedica il suo sapere ad ogni pennellata, modellando il pregio di questo materiale donando unicità a ogni lastra. Per questi motivi le texture risulteranno diverse, non uniformi e non omologate allo standard, frutto reale di impegno manuale e ricercato di un lavoratore di una grande azienda manifatturiera.

The artisan who carries out the treatment applies their expertise to each brushstroke, shaping the value of this material and imbuing each slab with uniqueness. For these reasons, the textures will be different, non-uniform and non-standardised, the real fruit of the painstaking manual effort of a worker in a large manufacturing company.

**LE COLORAZIONI**  
LE COLORAZIONI

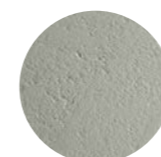

CM61 Grigio - Grey

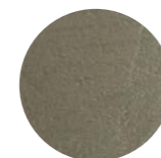

CM90 Tortora - Tortora

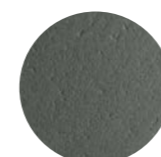

CM98 Grafite - Graphite

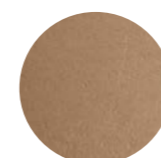

CM62 Terra - Terra





# Partnership creativa

Creative Partnership

Una vera partnership creativa iniziata nel 2005 e che si arricchisce di incontri, progetti, innovazioni sorprendenti.

A real creative partnership started in 2005 that enriches, year by year, of encounters, project, surprising innovations.

La continua collaborazione con designer italiani e di tutto il mondo è fondamentale per l'idea alla base della filosofia OZZIO ITALIA: rivoluzionare l'abitare moderno, definito da spazi sempre più ridotti, creando mobili trasformabili, polifunzionali, con diverse destinazioni d'uso.

The continuous collaboration with italian and worldwide designers is fundamental for the idea at the root of OZZIO ITALIA philosophy: to reinvent the modern living, defined by ever shrinking spaces, creating transformable and multifunctional pieces of furniture, with multiple intended uses.



Davide Carlesi  
architetto



Gabriele Cappelletti  
architetto



Giuliano Cappelletti  
architetto



Giulio Manzoni  
architetto



Massimiliano Mornati  
architetto



Studio Ozeta  
designer team



Andrea Lucatello  
architetto



Marco Pozzoli  
designer



Luca Roccadria  
designer



Luca Tonelli  
architetto



Yoshino Toshiyuki  
architetto



# Minux

Design  
Marco Pozzoli

La consolle più stretta al mondo misura solo 20 cm di profondità! Minux si presenta come un discreto elemento d'arredo, celando al suo interno allunghe che le permettono di allungarsi fino a 162 cm, ospitando fino a 8 persone. Meccanismo a compasso in alluminio, con piano, allunghe e gambe in legno.

The smallest console in the world measures only 20 cm deep! Minux looks like a discreet piece of furniture, concealing extensions inside that allow it to stretch up to 162 cm, accommodating up to 8 guests. Compass mechanism in aluminum, with extensions and legs in wood.



● T029 Minux  
consolle - console  
PW96





● T029 Minux  
console  
console  
PW96

● S011 Cubix  
pouf trasformabile  
transformable pouf  
B03 MT97

● S208 Plio  
sedia pieghevole  
folding chair  
PL18 MT98

● X401 Ring Light  
lampada a sospensione  
suspension lamp  
PZ94

● X039 Golden Big  
specchio  
mirror  
PW94

● X307 Trilogy  
madia  
sideboard  
X20 X06 MT98

CONSOLLE | Consoles

MINUX



● T029 Minux  
consolle - console  
PW96





90x20 H. 75  
35.4"x7.9" H. 29.5"

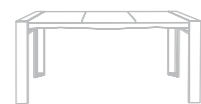

162x90 H. 75  
63.8"x35.4" H. 29.5"



chiuso  
closed  
20  
7.9"

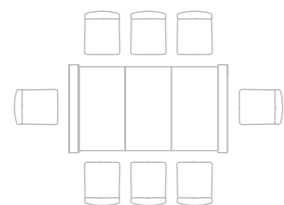

allungamento  
extension  
162  
63.8"

● T029 Minux  
consolle - console  
PW61

● X035 Soho  
specchio - mirror  
X01



# CO4L

Design  
Giulio Manzoni

CO4L è una consolle dall'elevato impatto visivo e un elemento di arredo perfetto per vari ambienti, da scrittoio a punto di appoggio per un ingresso. Il top dal forte spessore, oltre a esaltare le essenze legno, cela al suo interno 3 allunghe a libro che permettono a questa consolle di allungarsi fino a 183,5 cm. Basamento in metallo verniciato caratterizzato da 4 gambe perimetrali le quali garantiscono comodità di seduta anche in larghezza.

CO4L is a console with a high visual impact and a perfect piece of furniture for various environments, from a desk to a support table for an entrance. The thick top, in addition to enhancing the wood essences, conceals 3 folding extensions that allow this console to extend up to 183.5 cm. Base in painted metal characterized by 4 perimeter legs which guarantee sitting comfort even in width.



● T031 CO4L  
consolle - console  
PZ91 MT97

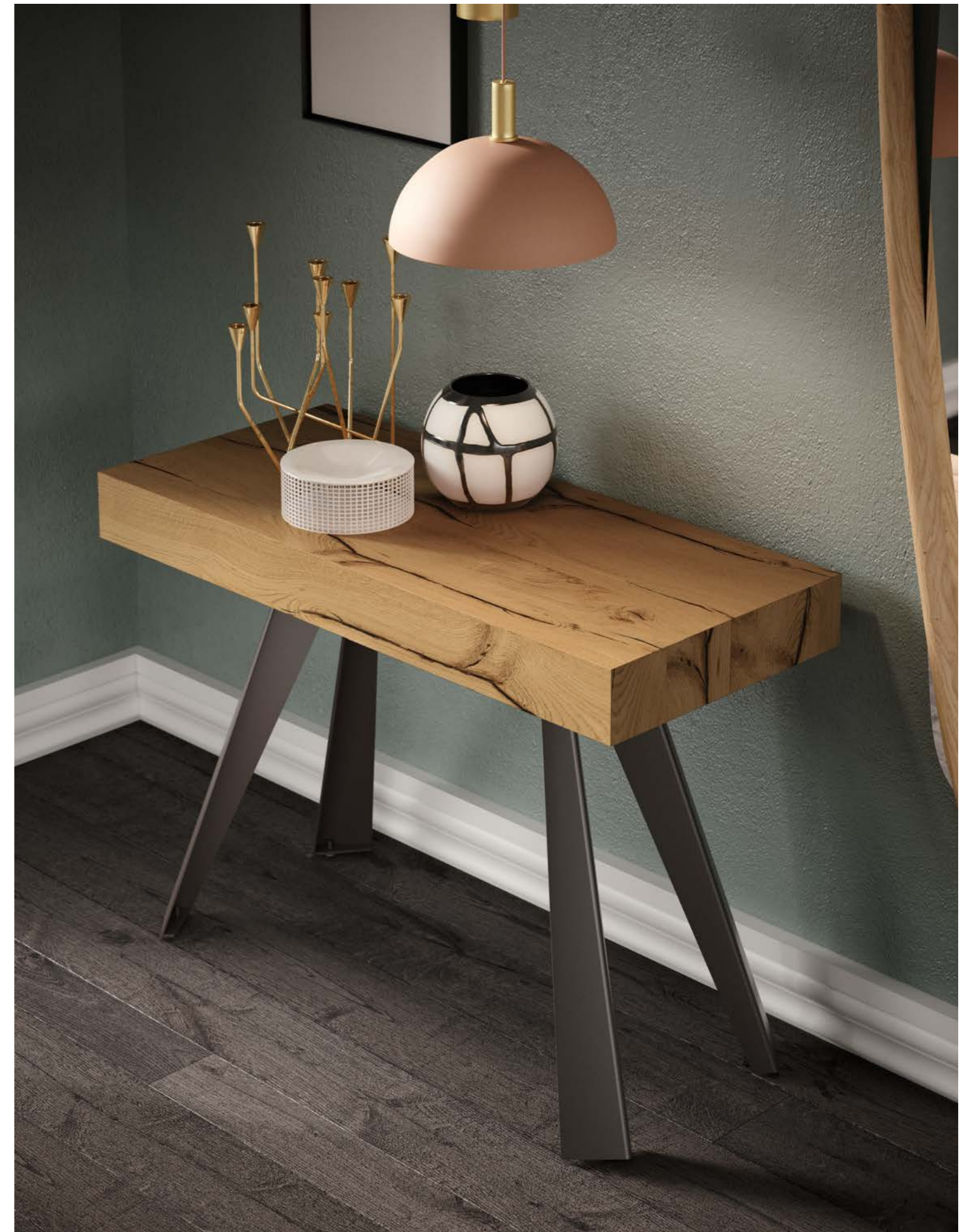



● T031 CO4L  
consolle - console  
PZ91 MT97

● X037 Golden wood  
specchio - mirror  
PW91

● T253 Papillon  
tavolo - table  
CR14 PW91

● S321 Blitz  
sedia - chair  
P19





● T031 CO4L  
consolle - console  
PZ91 MT97



110x48,5 H. 77,5  
43.3"x19" H. 30.5"

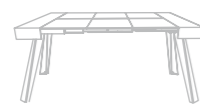

183,5x110 H. 77,5  
72"x 43.3" H. 30.5"



chiuso  
closed  
48,5  
19"

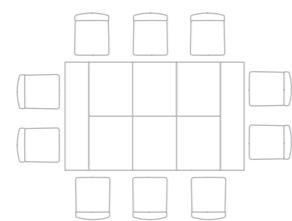

allungamenti  
extensions  
step 1 93,5 - 36.8"  
step 2 138,5 - 54.5"  
step 3 183,5 - 72"

● T031 CO4L  
consolle - console  
PZ91 MT97

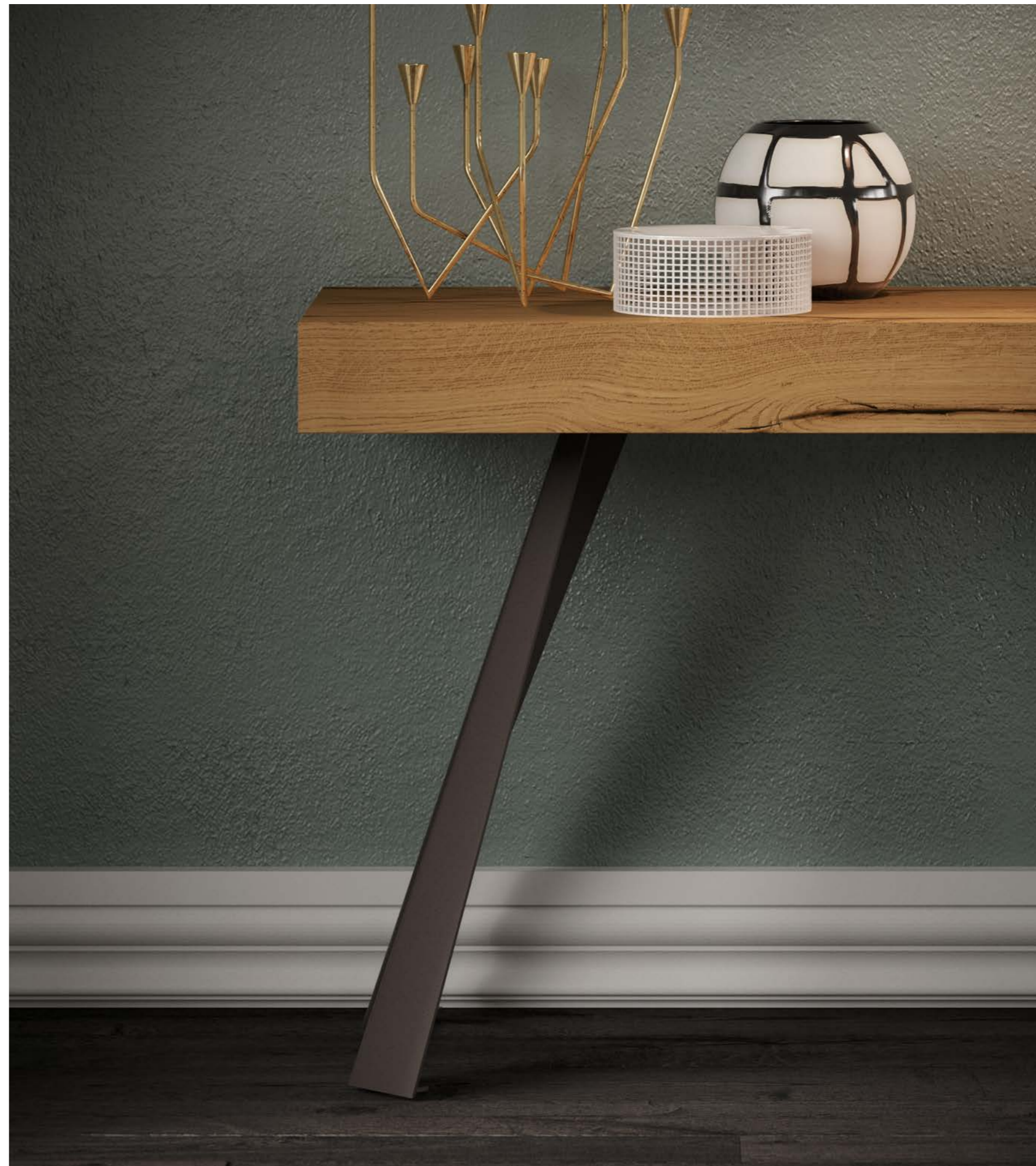

# 4YOU

Design  
Giulio Manzoni

4YOU è un elemento di design che nasconde grandi prestazioni. Questa consolle si adatta ad ogni spazio della casa grazie al suo ingombro limitato, con semplici gesti diventa tavolo da pranzo e può accomodare fino a 10 persone. Il sistema brevettato, con guide in alluminio, accoglie all'interno del top fino a tre allunghe a libro che rimangono completamente nascoste. La base di metallo verniciata è caratterizzata da un disegno dalla forte personalità.

4YOU is a design element that conceals great performance. This console adapts to any space in the home thanks to its limited size, with simple gestures it becomes a dining table and can seat up to 10 people. The patented system, with aluminium guides, accommodates up to three folding extension leaves inside the top, which remain completely hidden. The painted metal base is characterised by a design with a strong personality.



● T024 4YOU  
consolle - console  
PZ94 MT97

T024 4YOU | consolle - console | PZ94 MT98

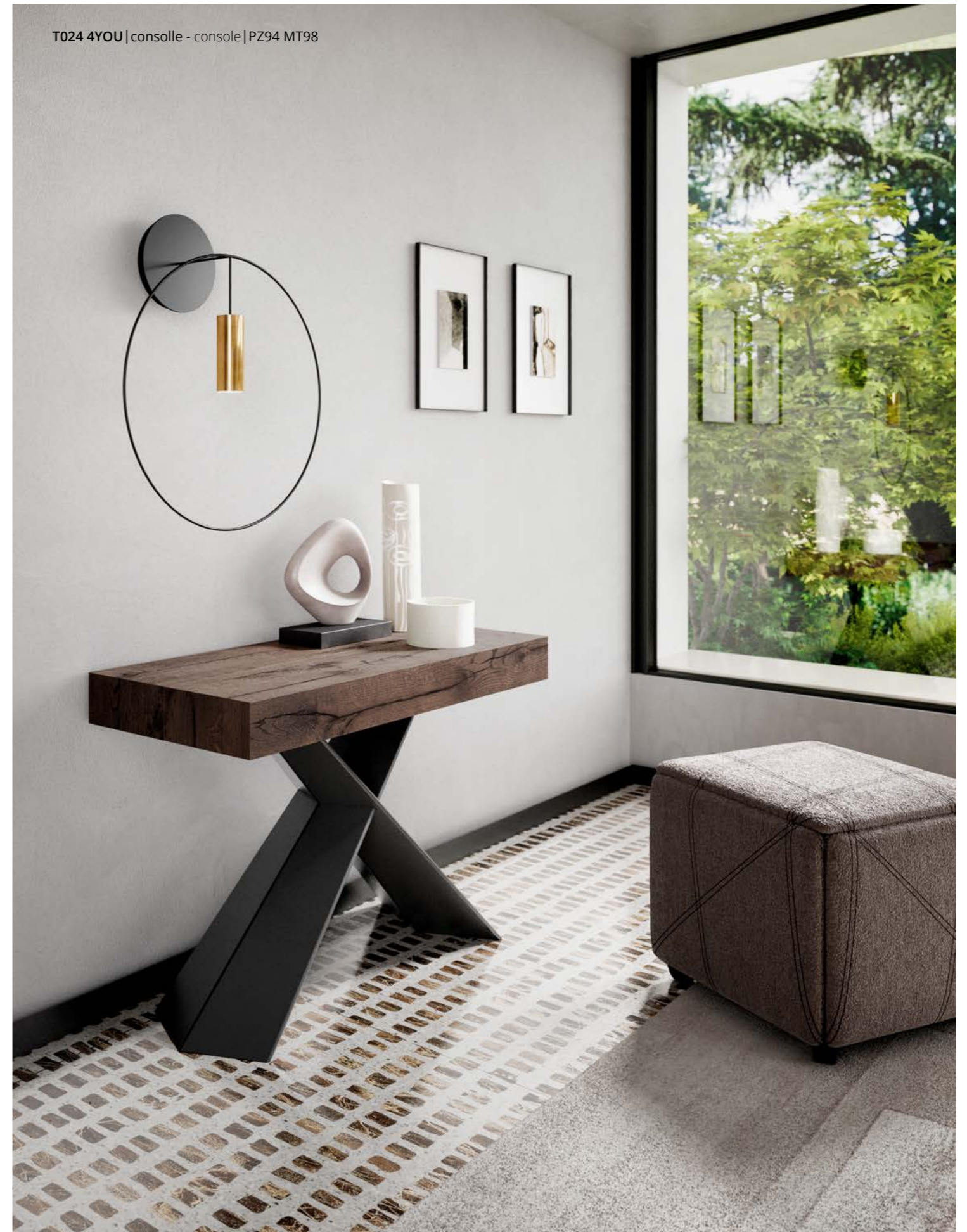



● T024 4YOU  
consolle - console  
PZ94 MT98

● S322 Lunette  
sedia - chair  
C32



● T024 4YOU  
consolle - console  
PW91 MT98





110x48,5 H. 75,5  
43.3"x19" H. 29.7"

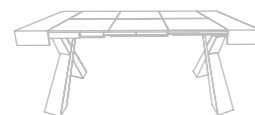

183,5x110 H. 75,5  
72.2"x43.3" H. 29.7"



chiuso  
closed  
48,5  
19"

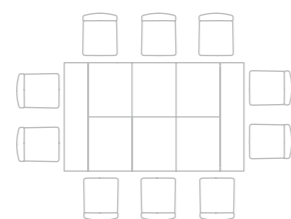

allungamenti  
extensions  
step 1 93,5 - 36.8"  
step 2 138,5 - 54.5"  
step 3 183,5 - 72.2"



● T024 4YOU  
consolle - console  
PW96 MT97

# A3

Design  
Marco Pozzoli  
Giacomo Mauri

A3 è la versione "big" dell'iconica consolle A4. Diventa un tavolo da pranzo in grado di accomodare fino a 14 ospiti in soli 40 cm di profondità da chiusa. Le 5 allunghe sono racchiuse nella gamba centrale girevole, che garantisce a tutti un elevato comfort di seduta.

The world's largest console table is only 40 cm deep! A3 becomes a dining table that can seat up to 14 guests. The 5 extensions are enclosed in the central swivel leg, which guarantees a high level of seating comfort for everyone.



T023 A3  
consolle - console  
PW91





● T023 A3  
consolle - console  
PW91

● S321 Blitz  
sedia - chair  
C25

● X038 Miami Vice  
specchio - mirror  
MG03

● X403 Botticelle  
lampada sospensione - suspension lamp  
CR22 CR20





T023 A3  
consolle - console  
PW91





● T023 A3  
consolle - console  
PW94

● X035 Soho  
specchio - mirror  
P20





112x40 H. 75  
44"x15.7" H. 29.5"

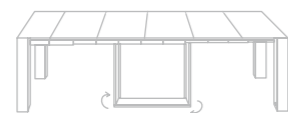

330x112 H. 75  
129.9"x 44" H. 29.5"



chiuso  
closed  
40  
15.7"



allungamenti  
extensions  
step 1 98 - 38.6"  
step 2 156 - 61.4"  
step 3 214 - 84.2"  
step 4 272 - 107"  
step 5 330 - 129.9"

● T023 A3  
consolle - console  
PW94

● X028 Manga  
libreria - bookcase  
PW94 MT97

● S055 Muriel  
poltroncina - armchair  
P11 MT12



# A4

Design  
Marco Pozzoli  
Giacomo Mauri

L'iconica consolle A4 diventa un tavolo pranzo fino a 10 posti, ideale per il living informale. Il suo sostegno centrale girevole garantisce a tutti un elevato comfort di seduta, oltre che nascondere le 4 allunghe. Dotata di ruote per facilitarne l'allungamento e lo spostamento, realizzata in finiture legno dalla spiccata personalità.

The iconic A4 console table becomes an occasional dining table seating up to 10, ideal for informal living. Its swivelling central support guarantees everyone a high level of comfort, on top of holding the 4 extensions. Equipped with castors for easy extension and movement, it comes in a wood finish with a strong personality.



T021 A4  
consolle - console  
PZ94

T021 A4 | consolle - console | PZ94





● T021 A4  
consolle  
console  
PZ94

● S011 Cubix  
pouf trasformabile  
transformable pouf  
B05 MT97

● S215 Ripiego  
sedia pieghevole  
folding chair  
PW96 MT97

● X016 Panto  
libreria  
bookcase  
PW96 CR21 MT97

● X308 Plana  
madia  
sideboard  
MG03 X06 MT98

CONSOLLE | Consoles

A4

● T021 A4  
consolle - console  
PZ91



● T021 A4  
consolle - console  
PW94





85x35 H. 75  
33.5"x13.8" H. 29.5"

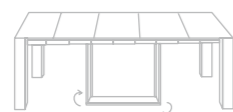

267x85 H. 75  
105"x33.5" H. 29.5"



chiuso  
closed  
35  
13.8"



allungamenti  
extensions  
step 1 93 - 36.6"  
step 2 151 - 59.4"  
step 3 209 - 82.2"  
step 4 267 - 105"



● T021 A4  
consolle - console  
PW94

# Golia

Design  
Marco Pozzoli  
Giacomo Mauri

Minimal ma dalla personalità multiforme la consolle best seller allungabile Golia garantisce stabilità e massima estensione con sole 5 allunghe esterne. Piano, gambe e allunghe in legno, meccanismo telescopico in alluminio e gamba centrale in tinta con una doppia funzione: sostegno a consolle aperta e rotazione di 90°, per favorire la libertà di seduta di tutti i commensali.

Minimal but with a versatile personality, the iconic Golia extendable console is presented in an open pore matt lacquered version. Wooden tops, legs and extensions, telescopic mechanism in aluminum and equipped with 5 external extensions of 50 cm each, lacquered in the same color. The central pivoting leg has a double function: support the top while the console is open, to give extra room sitting for all guests.



● T035 Golia  
consolle - console  
PW91

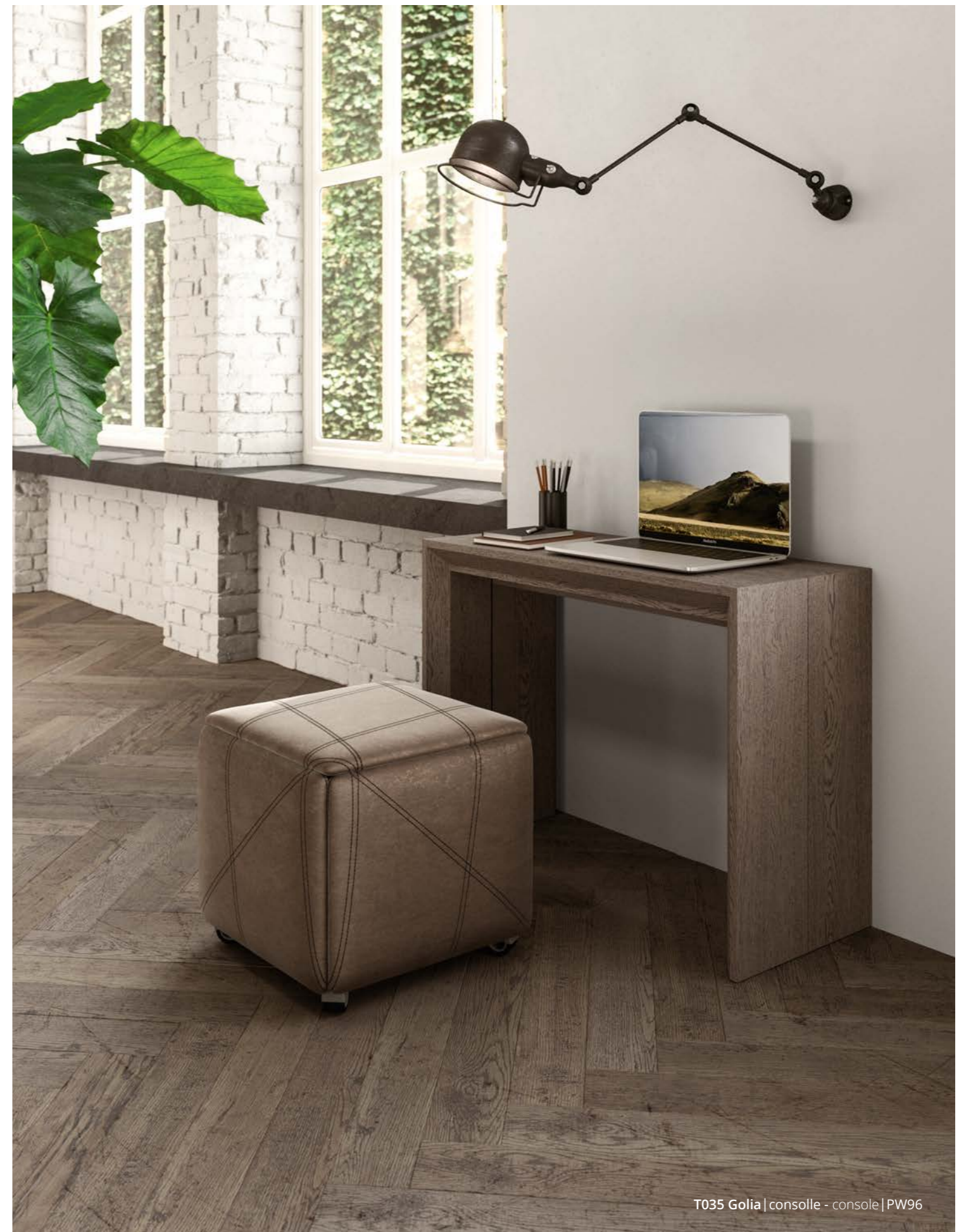

T035 Golia | consolle - console | PW96





● T035 Golia  
consolle - console  
PW96

● S011 Cubix  
pouf trasformabile - transformable pouf  
EP90 VE03 MT97

● S503 Milo  
sgabello - stool  
P11 MT97



● T035 Golia  
consolle - console  
PW96



100x43 H. 75  
39.4"x16.9" H. 29.5"

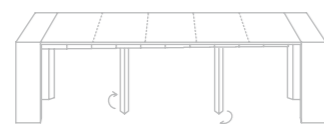

293x100 H. 75  
115.3"x39.4" H. 29.5"



chiuso  
closed  
43  
16.9"



allungamenti  
extensions  
step 1 93 - 36.6"  
step 2 143 - 56.3"  
step 3 193 - 76"  
step 4 243 - 95.7"  
step 5 293 - 115.3"

● T035 Golia  
consolle - console  
PW61

● S341 Frisbee  
sedia - chair  
C14





# Zoom

Design  
Marco Pozzoli  
Andrea Lucatello

Zoom è un perfetto tavolino di servizio, dotato di sistema di sollevamento a colonna regolabile al millimetro. Solido e informale, le sue caratteristiche multiuso gli consentono utilizzi di ogni tipo. L'elegante e capiente vassoio optional, in essenza con un leggero labbetto perimetrale sul top, si applica o toglie a seconda delle necessità.

Zoom is a perfect service table, equipped with a millimeter-adjustable column lifting system. Solid and informal, its multipurpose features allow it to be used of all kinds. The elegant and spacious optional tray, in essence with a slight perimeter lip on the top, can be applied or removed as needed.



● T058 Zoom  
tavolino multifunzione - multifunctional table  
MT97





● T058 Zoom  
tavolino multifunzione  
multifunctional table  
MT97 PW91





● T058 Zoom  
tavolino multifunzione  
multifunctional table  
MT98

● L010 Romance  
letto  
bed  
EP50 PZ94 MT97

● X401 Ring Light  
lampada sospensione  
suspension lamp  
PZ94

● X039 Golden Big  
specchio  
mirror  
PW96



65x48 H. 44  
25.6"x18.9" H. 17.3"



65x48 H. 62,5  
25.6"x18.9" H. 24.6"



trasformazione  
transformation  
altezza - height  
da 44 a 62,5  
from 17.3" to 24.6"



vassoio - tray  
66,6x49,6 H.2  
26.2"x19.5" H. 0.8"

● T058 Zoom  
| tavolino multifunzione - multifunctional table  
| MT98





# Bell

Design  
Marco Pozzoli  
Studio Tonelli & Carlesi

Il tavolino Bell si fonde nell'armonia del soggiorno disegnando morbide forme grazie ai suoi angoli smussati. La funzionalità nascosta al suo interno le permette di trasformarsi da tavolino basso a table dinette. Non meno importante è il contenitore che si svela quando il top si alza grazie al sistema brevettato occulto. La base in metallo verniciato riprende le forme sinuose del top.

The Bell coffee table blends into the harmony of the living room, drawing soft shapes thanks to its rounded corners. The functionality hidden inside allows it to transform from coffee table to dinette table. No less important is the storage that is revealed when the top is raised thanks to the patented hidden system. The painted metal base takes up the sinuous shapes of the top.



● T059 BELL  
tavolino multifunzione - multifunctional table  
PZ51 MT97



T059 Bell | tavolino multifunzione - multifunctional table | PZ93 MT97



● T059 Bell  
tavolino multifunzione - multifunctional table  
PZ93 MT97

● X309 Brera TV  
madia - sideboard  
PW96 X06 MT98

● X503 Kony  
tavolino - coffee table  
CC07 PW96 MT16 MT97



117x68 H. 30  
46"x26.8" H. 11.8"



117x99,6 H. 63  
46"x39.2" H. 24.8"



trasformazione  
transformation  
altezza - height  
da 30 a 63  
from 11.8" to 24.8"

larghezza - width  
da 68 a 99,6  
from 26.8" to 39.2"

● T059 Bell  
tavolino multifunzione - multifunctional table  
PZ93 MT97



# Bellagio

Design  
Marco Pozzoli

Il tavolino multifunzionale Bellagio è un pratico completamento polivalente per l'arredamento living contemporaneo. Il piano elevabile ammortizzato ne consente diversi utilizzi: come tavolino da soggiorno, o in posizione elevata quale versatile appoggio per colazione, gioco, notebook... e molto altro. L'organizzazione e la praticità non sono trascurate grazie al pratico scomparto in grado di contenere riviste, accessori e oggetti pronti all'uso.

The Bellagio multifunctional coffee table is a practical and multifunctional addition to contemporary living. The shock-absorbing, elevating top allows for a variety of uses: as a coffee table, or in an elevated position as a versatile support for breakfast, games, notebooks... and much more. Organisation and practicality are not neglected thanks to the practical compartment that can hold magazines, accessories and ready-to-use items.



● T061 Bellagio  
tavolino multifunzione - multifunctional table  
MG02 CR14



T061 Bellagio | tavolino multifunzione - multifunctional table | MG05 CM62 CR14



● **T061 Bellagio**  
| tavolino multifunzione - multifunctional table  
| MG05 CM62 CR14

● **X032 Brera**  
| madia - sideboard  
| X01 MT98

● **X402 Astrum**  
| lampada - lamp  
| PW91 MT97

● **X502 Bijoux**  
| tavolino - coffee table  
| CC11 MT98

TAVOLINI MULTIFUNZIONE | Multifunctional coffee tables

BELLAGIO



● T061 Bellagio  
tavolino multifunzione  
multifunctional table  
MG02 CR21





117x68 H. 32  
46"x26.8" H. 12.6"



117x97 H. 65  
46"x38.2" H. 25.6"

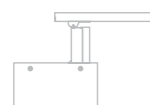

trasformazione  
transformation  
altezza - height  
da 32 a 65  
from 12.6" to 25.6"

larghezza - width  
da 68 a 97  
from 26.8" to 38.2"

● **T061 Bellagio**  
tavolino multifunzione - multifunctional table  
PW94 CR21



# Aurelius

Design  
Marco Pozzoli

La sinuosa rielaborazione dell'iconico tavolino multifunzione Markus è esaltata nel nuovo modello: Aurelius. Le spigolature sono state smussate e le proporzioni rivoluzionate, da rettangolari a quadrate. L'organizzazione degli spazi è riposta all'interno del top grazie al pratico scomparto in grado di contenere riviste, accessori e oggetti pronti all'uso, nascondendo tutto con discrezione chiudendo con un gesto il piano ammortizzato e silenzioso.

The sinuous reworking of the iconic Markus multifunctional table is enhanced in the new model: Aurelius. The edges have been smoothed out and the proportions revolutionised from rectangular to square. The organisation of space is stored inside the top thanks to the practical compartment that can hold magazines, accessories and ready-to-use objects, hiding everything discreetly by closing the cushioned and silent top with a gesture.



● T067 Aurelius  
tavolino multifunzione - multifunctional table  
PW96 CR21



T067 Aurelius | tavolino multifunzione - multifunctional table | PZ94 CR21





● **T067 Aurelius**  
tavolino multifunzione - multifunctional table  
PZ94 CR21

● **T058 Zoom**  
tavolino multifunzione - multifunctional table  
MT97 PW94

● **S341 Frisbee**  
sedia - chair  
C25



● **T067 Aurelius**  
| tavolino multifunzione - multifunctional table  
| PZ94 CR21



120x120 H. 32  
47.2"x47.2" H. 12.6"



120x153 H. 65,4  
47.2"x60.2" H. 25.7"



trasformazione  
transformation  
altezza - height  
da 32 a 65,4  
from 12.6" to 25.7"

larghezza - width  
da 120 a 153  
from 47.2" to 60.2"

● T067 Aurelius  
tavolino multifunzione - multifunctional table  
PW91 CR14



# Markus

Design  
Marco Pozzoli

Date le notevoli dimensioni, il tavolino multifunzione Markus consente di svolgere tutte quelle attività che richiedono spazio come lavorare, leggere, scrivere o fare uno spuntino. Inoltre, l'innovativa panca può accomodare ulteriori ospiti e consentire attività conviviali e di svago. I piedi in vetro alleggeriscono visivamente la struttura e esaltano il design delle finiture legno del top di 6 cm di spessore.

Due to its large size, the Markus multifunctional table allows for all space-consuming activities such as working, reading, writing or snacking. In addition, the innovative bench can accommodate additional guests and allow for convivial and leisure activities. The glass feet visually lighten the structure and enhance the design of the 6 cm-thick top wood finish.



● T063 Markus  
tavolino multifunzione - multifunctional table  
PZ51 CR21





● T063 Markus  
tavolino multifunzione  
multifunctional table  
PZ51 CR21

● X504 Moved  
tavolini  
coffee tables  
VB01 MT97

● S462 Halia  
poltroncina  
armchair  
P12 MT97

● X401 Atollo  
lampada sospensione  
suspension lamp  
PZ94



● T063 Markus  
tavolino multifunzione  
multifunctional table  
PZ51 CR21





140x90 H. 32  
55"x35.4" H. 12.6"

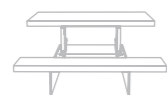

140x124 H. 65  
55"x48.8" H. 25.6"

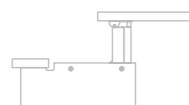

trasformazione  
transformation  
altezza - height  
da 32 a 65  
from 12.6" to 25.6"

larghezza - width  
da 90 a 124  
from 35.4" to 48.8"

● T063 Markus  
tavolino multifunzione - multifunctional table  
PW94 CR14



# Metrino

Design  
Marco Pozzoli  
Giacomo Mauri

Un "table dinette" che offre una duplice funzione nel minimo spazio. Un utile contenitore per piccoli oggetti e un piano elevabile per un pratico appoggio multifunzionale.

A dinette table that offers a double function in minimum spaces, a useful container for small objects and an elevating top for a practical multifunctional support.



● T062 Metrino  
tavolino multifunzione - multifunctional table  
PW94 MT98







● **T062 Metrino**  
tavolino multifunzione - multifunctional table  
PW97 MT97

● **X028 Manga**  
libreria - bookcase  
PW97 MT97

● **T058 Zoom**  
tavolino multifunzione - multifunctional table  
MT97



117x68 H. 32  
46"x26.8" H. 12.6"

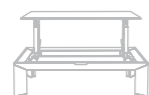

117x102 H. 65  
46"x40" H. 25.6"

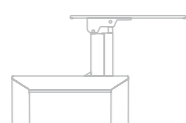

trasformazione  
transformation  
altezza - height  
da 32 a 65  
from 12.6" to 25.6"

larghezza - width  
da 68 a 102  
from 26.8" to 40"

● T062 Metrino  
| tavolino multifunzione - multifunctional table  
| PW97 MT97



# Radius

Design  
Marco Pozzoli

Radius è un tavolino elevabile multifunzionale. Il suo design logico e coerente presenta una base stilizzata in forma leggera. Elevando il piano si scoprono capienti scomparti per riporre riviste e piccoli oggetti d'uso quotidiano.

Radius is an elevating multifunctional table. Its logic and coherent design presents a lightly shaped base. Large storage compartments become available when the top is lifted.

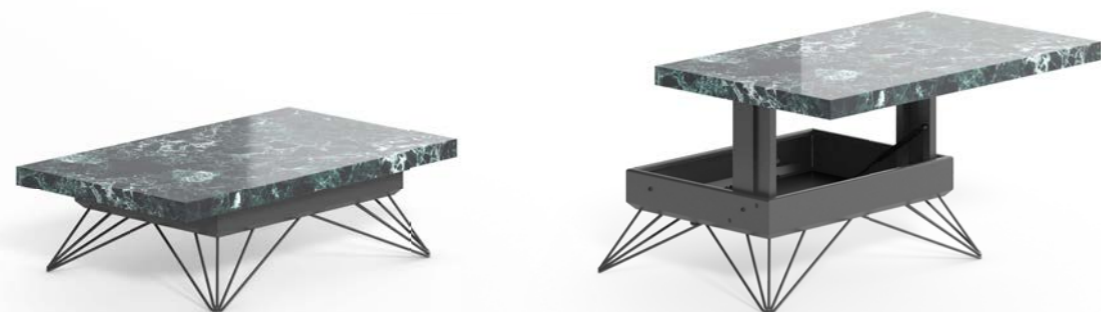

● T064 Radius  
tavolino multifunzione - multifunctional table  
MG04 MT98





● **T064** Radius  
tavolino multifunzione  
multifunctional table  
MG04 MT98

● **X400** Discovery  
lampada da terra  
floor lamp  
PZ94 MT97

● **S011** Cubix  
pouf trasformabile  
transformable pouf  
B03 VE04 MT97

● **X037** Golden Wood  
specchio  
mirror  
PW96



117x68 H. 32  
46"x26.8" H. 12.6"



117x101,5 H. 65  
46"x40" H. 25.6"

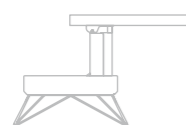

trasformazione  
transformation  
altezza - height  
da 32 a 65  
from 12.6" to 25.6"

larghezza - width  
da 68 a 101,5  
from 26.8" to 40"

● T064 Radius  
| tavolino multifunzione - multifunctional table  
| MG03 MT98





# Ellis

Design  
Giulio Manzoni

Ellis è l'ultima frontiera della trasformabilità. Grazie alle sue allunghe ad "ala", che gli consentono di mutare nella forma e nella funzionalità da rettangolare ad ovale, questo tavolino trasformabile dà la possibilità di sfruttare 8 e più posizioni di apertura. Il basamento in legno massello ad "incrocio" abbinato al top, si alza e abbassa al millimetro per sincronizzarsi alle molteplici funzionalità di apertura del piano.

Ellis is the latest frontier of transformability. Thanks to its "wing" extensions, which allow it to change the shape and functionality from rectangular to oval. This transformable table gives the possibility to enjoy 8 and more opening positions. The "crossing" solid wood base combined with the top, it is adjustable to the millimeter to synchronize with the multiple opening functions of the top.



● T132 Ellis  
tavolino trasformabile - transformable table  
PW91

T132 Ellis | tavolino trasformabile - transformable table | PW96

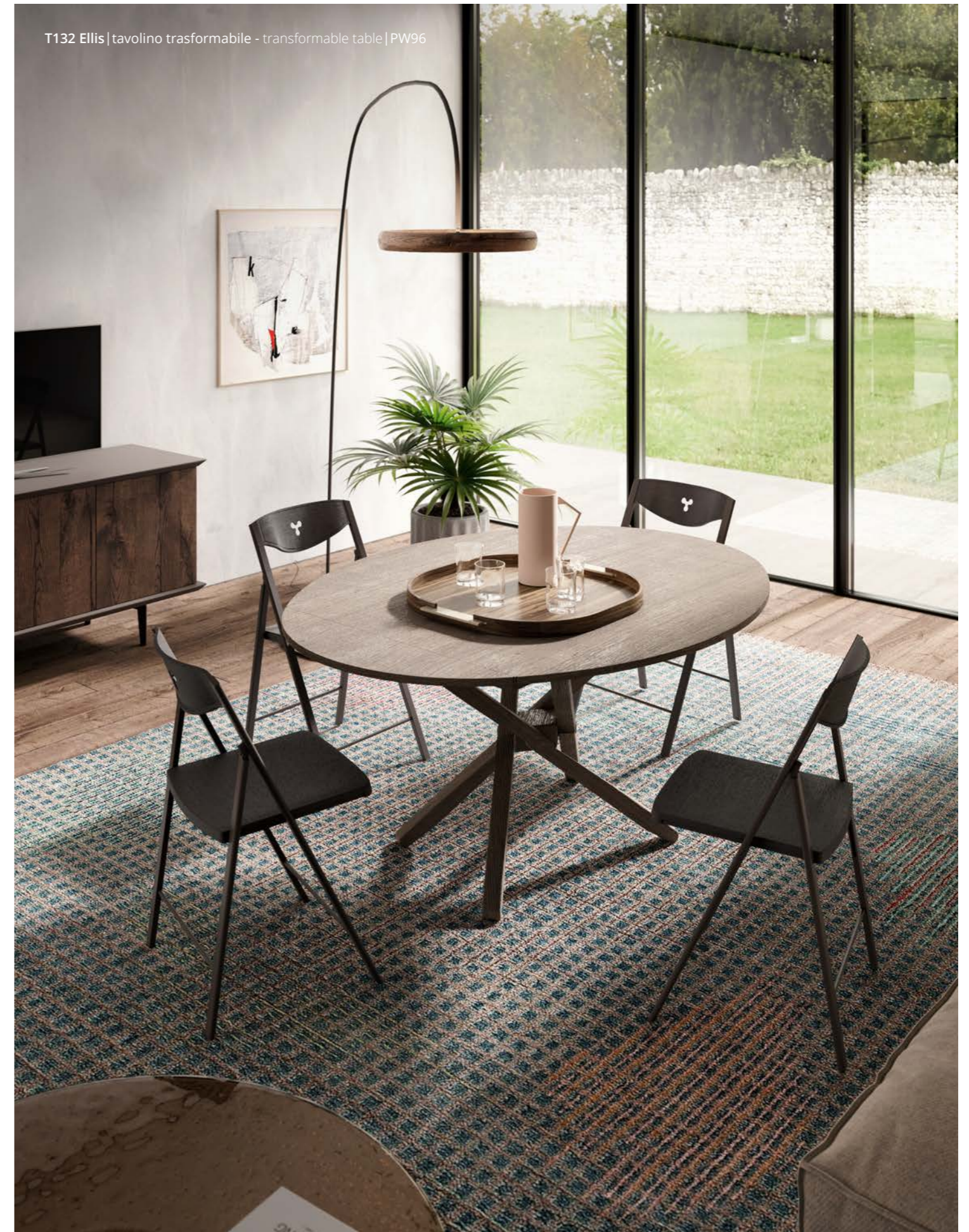



● T132 Ellis  
tavolino trasformabile - transformable table  
PW96

● X312 Brera Vetro  
madia - sideboards  
PZ94 CR21 X17 MT98

● X402 Astrum  
lampada arco - arc lamp  
PZ94 MT97

● X504 Moved  
tavolini - coffee table  
VB01 MT97

TAVOLINI TRASFORMABILI | Transformable tables

ELLIS



## Tutte le Forme di Ellis

All the Ellis Shapes



Ellis abbassato  
Ellis lower position



Ellis posizione intermedia.  
Qualsiasi regolazione in altezza è ottenibile al millimetro.  
Ellis half lifted. Any height adjustment is achievable to the millimetre.



Ellis massima altezza  
Ellis highest position



01.

Piano rettangolare non allungato  
Rectangular top not extended



04.



07.



02.



05.



08.



03.



06.



09.

Piano completamente allungato in forma ovale  
Fully extended top in oval shape

Infinite regolazioni in altezza sono abbinabili a qualsiasi estensione del piano.  
Infinite height adjustments can be combined with any top extension.



120x80 H. 32  
47.2"x31.5" H. 12.6"



160x120 H. 74  
63"x47.2" H. 29"



chiuso  
closed  
120  
47.2"

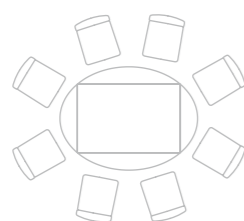

allungamenti in larghezza  
length extensions  
step 1 140 - 55"  
step 2 160 - 63"

allungamenti in profondità  
dept extensions  
step 1 100 - 39.4"  
step 2 120 - 47.2"

● T132 Ellis  
tavolino trasformabile - transformable table  
PW96



# Jolly

Design  
Giulio Manzoni

Jolly è un tavolino trasformabile con basamento incrociato in legno che si fonde con l'ambiente circostante grazie alla finitura abbinata del top. Un connubio ideale per spazi conviviali, data anche la facilità di apertura con allunga nascosta nel piano che permette l'allungamento fino a 177 cm.

Jolly is a transformable coffee table with a crossed wooden base that blends into the living area thanks to the matching finish of the top. An ideal combination for convivial spaces, also given the ease of opening with extension hidden in the top that allows extension up to 177 cm.



● T133 Jolly  
tavolino trasformabile - transformable table  
PW61



T133 Jolly | tavolino trasformabile - transformable table | PW97



● T133 Jolly  
tavolino trasformabile - transformable table  
PW97

● X312 Brera vetro  
madia - sideboards  
X18 CR21 MT98

● X040 Kelly  
specchi - mirror  
VS01

● X400 Discovery  
lampada da terra - floor lamp  
PZ94 MT97

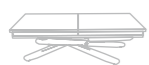

115x76 H. 33  
45.2"x29.9" H. 13"



177x76 H. 75  
69.7"x29.9" H. 29.5"



chiuso  
closed  
115  
45.2"

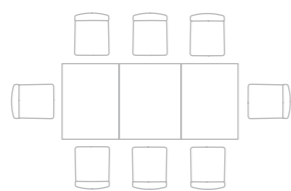

allungamento  
extension  
177  
69.7"

● T133 Jolly  
| tavolino trasformabile - transformable table  
| PW97



# Su e Giù

Design  
Giulio Manzoni

Tavolino da salotto che diventa tavolo da pranzo, per la prima volta completamente in legno. Il basamento incrociato, regolabile a tutte le altezze al millimetro, si armonizza con il piano allungabile a libro. Questo eccezionale complemento d'arredo è in grado di fondersi completamente con l'ambiente living, infatti il gioco di incroci del basamento elevabile crea un connubio perfetto tra design ed efficienza.

Coffee table that becomes a dining table, completely made of wood for the first time. The crossed base, adjustable at any height, perfectly matches with the extendable folding top. This extraordinary piece of furniture is able to harmoniously stand out with the living environment, in fact the game of intersections of the elevating base creates a perfect combination of design and efficiency.



● T101 Su e Giù  
tavolino trasformabile - transformable table  
PW94





● T101 Su e Giù  
| tavolino trasformabile - transformable table  
PW94

● S011 Cubix  
| pouf trasformabile - transformable pouf  
VE05



● **T101** Su e Giù  
tavolino trasformabile - transformable table  
PW94

● **S011** Cubix  
pouf trasformabile - transformable pouf  
VE05

● **S208** Plio  
sedia pieghevole - folding chair  
PL18 MT98

TAVOLINI TRASFORMABILI | Transformable tables

SU E GIÙ





115x75 H. 35  
45.2"x29.5" H. 13.8"

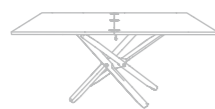

150x115 H. 74  
59x45.2" H. 29"



chiuso  
closed  
75  
29.5"

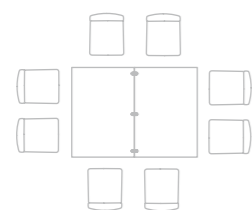

allungamento  
extension  
150  
59"

● **T101** Su e Giù  
| tavolino trasformabile - transformable table  
| PW94



# Leonardo

Design  
Marco Pozzoli

La continua ricerca di nuove soluzioni progettuali e l'interpretazione delle esigenze abitative del living moderno hanno portato alla costruzione di un prodotto geniale: Leonardo! Questo è l'unico tavolino trasformabile al mondo regolabile in: larghezza, lunghezza e altezza. Grazie alle sue funzioni intrinseche può diventare un tavolo da pranzo per 10 persone partendo da un coffee table ad altezza regolabile.

The continuous search for new design solutions and the interpretation of the living requirements of modern living have led to the construction of an ingenious product: Leonardo! This is the only convertible table in the world that can be adjusted in width, length and height. Thanks to its intrinsic functions, it can become a dining table for 10 people from a height-adjustable coffee table.



● T129 Leonardo  
tavolino trasformabile - transformable table  
PW96 MT98

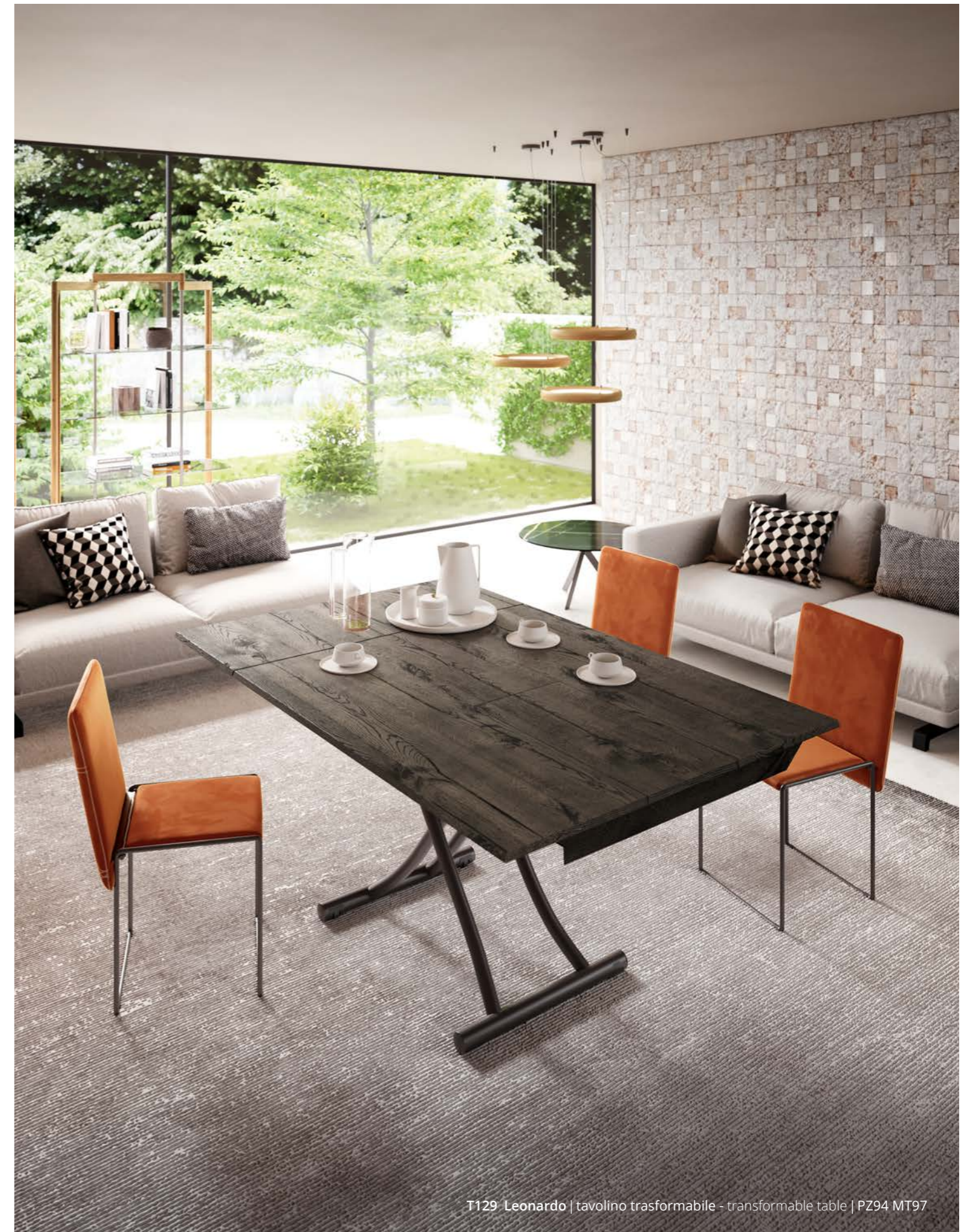

T129 Leonardo | tavolino trasformabile - transformable table | PZ94 MT97



● **T129 Leonardo**  
tavolino trasformabile  
transformable table  
PZ94 MT97

● **S011 Cubix**  
pouf trasformabile  
transformable pouf  
VE07

● **T058 Zoom**  
tavolino multifunzione  
multifunctional table  
MT97 PW91

● **X311 Giulia**  
madia  
sideboard  
VB01 X17 CR14



## La trasformazione di Leonardo The Leonardo's transformability

- 01 • Leonardo - piano chiuso  
Leonardo - closed top



- 02 • Leonardo - piano semiaperto  
Leonardo - semi open top

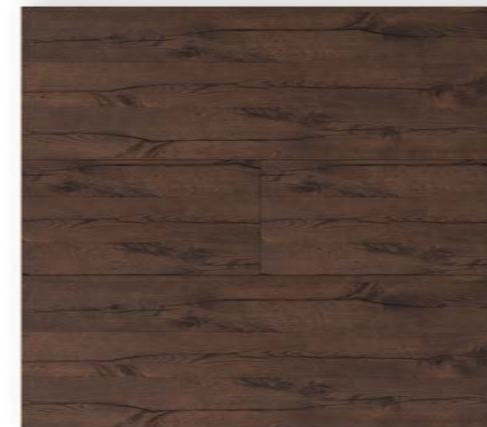

- 03 • Leonardo - piano aperto  
Leonardo - open top

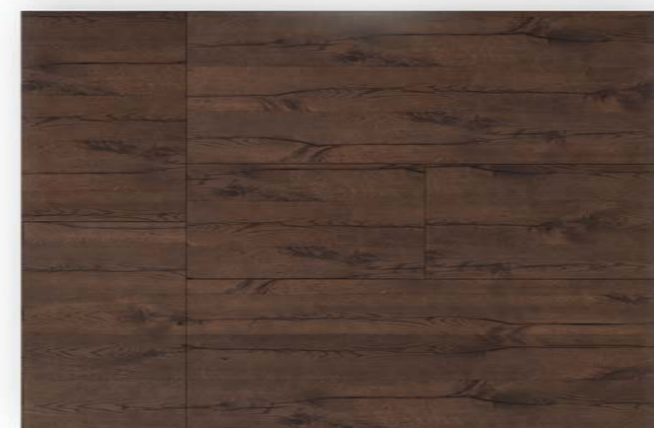



125x80 H. 29  
49.2"x31.5" H. 11.4"



168x110 H. 86  
66"x43.3" H. 33.8"



chiuso  
closed  
125  
49.2"

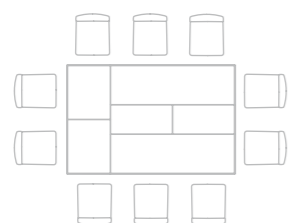

allungamenti in larghezza  
length extensions  
step 1 125 - 49.2"  
step 2 168 - 66"  
  
allungamenti in profondità  
dept extensions  
step 1 110 - 43.3"

● T129 Leonardo  
| tavolino trasformabile - transformable table  
| PW94 MT98



# Box

Design  
Studio Ozeta

Il top seller Box si rinnova attraverso la preziosa finitura Marble Glass. Iconico e multifunzione, questo tavolino trasformabile dall'aspetto essenziale è il cuore pulsante della convivialità domestica. Allunghe abilmente celate all'interno del piano, apertura telescopica sincronizzata, alzata assistita al millimetro con pistone a gas e ruote a scomparsa per una discreta movimentazione all'interno della zona living.

The top seller "Box" is renewed through the precious Marble Glass finishing. Iconic and multifunctional, this transformable table with an essential appearance is the beating heart of domestic conviviality. Extensions cleverly hidden inside the top, synchronized telescopic opening, millimeter-assisted lift with gas piston and hidden wheels for an easy movement in the living area.



● T110 Box  
tavolino trasformabile - transformable table  
CR01 MT92

T110 Box | tavolino trasformabile - transformable table | MG05 MT97

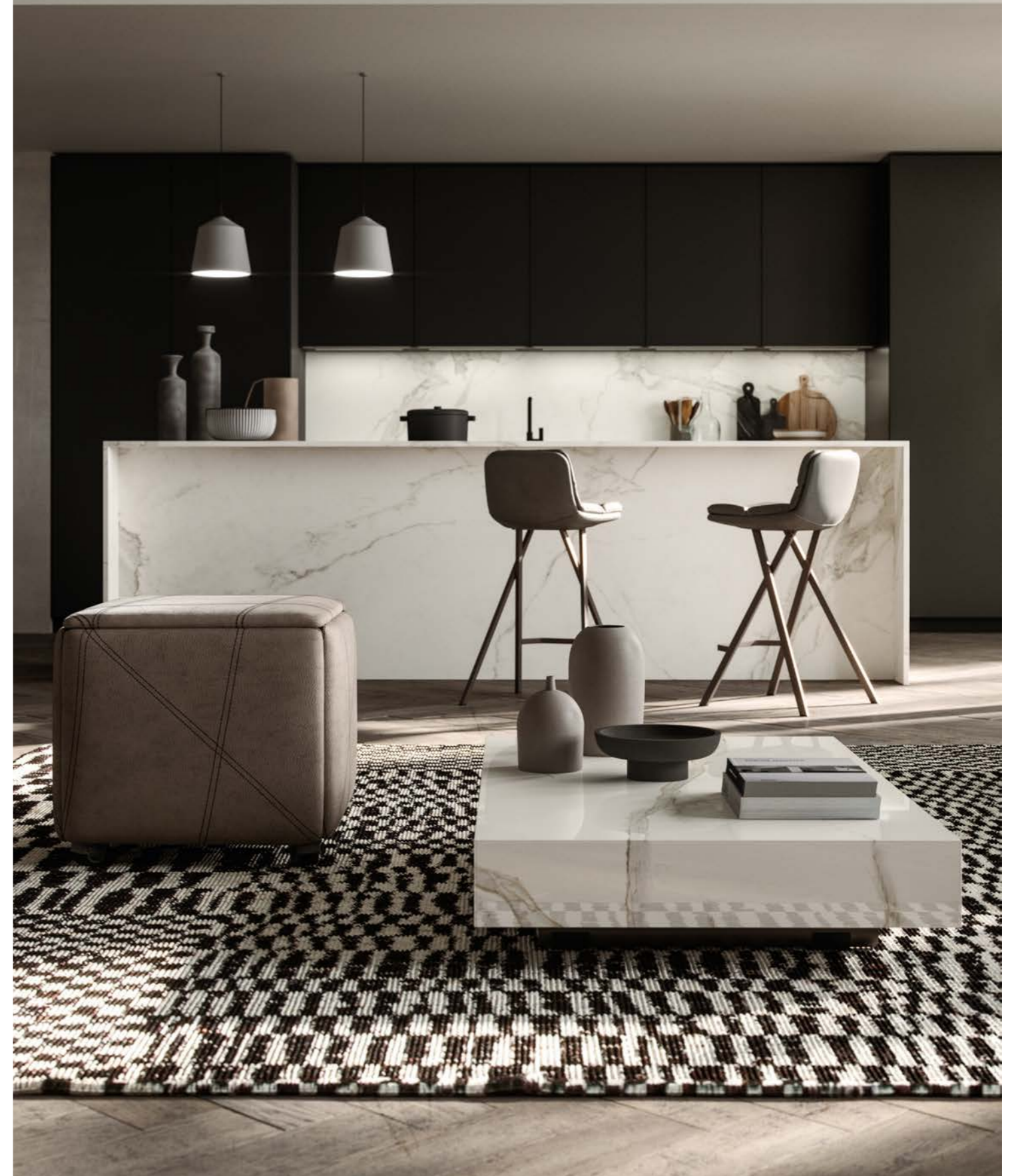



● **T110 Box**  
tavolino trasformabile - transformable table  
MG05 MT97

● **S011 Cubix**  
pouf trasformabile - transformable pouf  
EP90 VE03 MT97

● **S503 Milo**  
sgabelli - stools  
P11 MT97

● **T035 Golia**  
consolle - console  
PW96

TAVOLINI TRASFORMABILI | Transformable tables

BOX



● T110 Box  
tavolino trasformabile  
transformable table  
MG05 MT97





120x75 H. 25  
47.2"x29.5" H. 9.8"

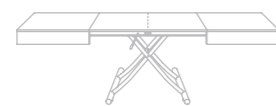

220x75 H. 84  
86.6"x 29.5" H. 33"



chiuso  
closed  
120  
47.2"



allungamenti  
extensions  
step 1 170 - 66.9"  
step 2 220 - 86.6"



● **T110 Box**  
tavolino trasformabile - transformable table  
CR01 MT98

# Box legno

Design  
Studio Ozeta

Box Legno si differenzia dall'omonimo Box per il top in essenza rovere e la pregiata finitura cemento. Il suo design lineare racchiude una tecnologia affidabile che cambia la forma e insieme la destinazione d'uso. Le due allunghe sono racchiuse all'interno del top, il meccanismo telescopico sincronizzato ne consente l'apertura con un semplice gesto.

Box Legno differs from its namesake Box in that it has an oak top and a fine cement finish. Its linear design encloses a reliable technology that changes the shape and at the same time the use. The two extensions are enclosed inside the top and the synchronised telescopic mechanism allows them to be opened with a simple gesture.



● T111 Box legno  
tavolino trasformabile - transformable table  
PW96 MT97



T111 Box legno | tavolino trasformabile - transformable table | PW94 MT98



● T111 Box legno  
| tavolino trasformabile - transformable table  
| PW94 MT98





120x75 H. 25  
47.2"x29.5" H. 9.8"



220x75 H. 84  
86.6"x29.5" H. 33"



chiuso  
closed  
120  
47.2"



allungamenti  
extensions  
step 1 170 - 66.9"  
step 2 220 - 86.6"

● T111 Box legno  
| tavolino trasformabile - transformable table  
| PW94 MT98



# Newood

Design  
Studio Ozeta

Newood è la nuova dimensione dello spazio, con doppio step di apertura per ospitare da 6 a 10 commensali. Da essenziale tavolino dal design curato e pulito a tavolo di forte spessore dove la sua stessa forma occulta sorprendenti "meccanismi". Regolabile in altezza al millimetro e due allunghe celate all'interno del top.

Newood is the new dimension of space, with a double opening step to accommodate from 6 to 10 diners. From an essential table with a neat and clean design to a thick table where its very shape conceals surprising "mechanisms". Height adjustable to the millimetre and two extensions concealed inside the top.

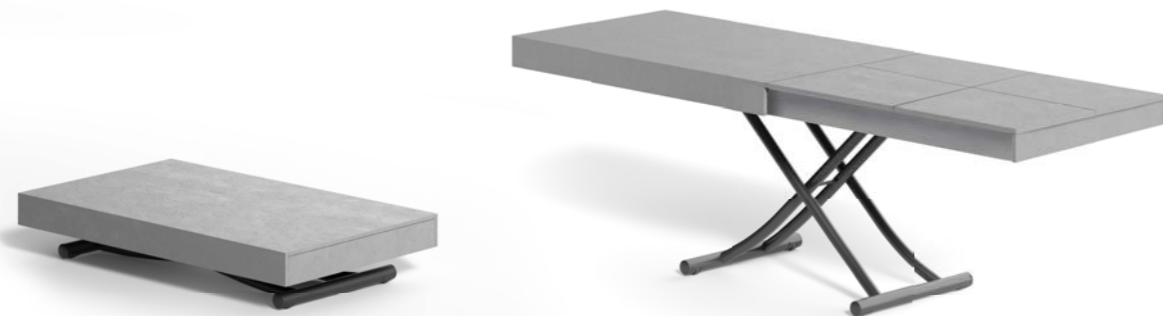

● T123 Newood  
tavolino trasformabile - transformable table  
CM61 MT98



T123 Newood | tavolino trasformabile - transformable table | PW94 MT98



● T123 Newood  
| tavolino trasformabile - transformable table  
PW94 MT98



T123 Newood  
tavolino trasformabile  
transformable table  
PZ91 MT97



126x76 H. 23  
49.6"x30" H. 9"

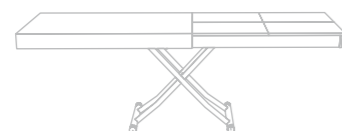

236x76 H. 80  
93"x30" H. 31.5"



chiuso  
closed  
126  
49.6"



allungamenti  
extensions  
step 1 181 - 71.2"  
step 2 236 - 93"



● T123 Newwood  
tavolino trasformabile - transformable table  
CM98 MT98



# Mondial Mondial CR

Design  
Studio Ozeta

Ironia e divertimento sono le basi dei progetti Mondial e Mondial CR. Tavolini polifunzionali ad altezza e assetto variabile, con apertura del top a libro raddoppiano lo spazio per un ambiente pranzo adatto ad ogni circostanza. Le rotelle facilitano la movimentazione e le funzionalità.

Irony and fun are the basis of the Mondial and Mondial CR projects. Multifunctional tables with variable height and trim, with top opening and folding, double the space for a dining environment suitable for all circumstances. Castors facilitate movement and functionality.



● T096 Mondial  
tavolino trasformabile - transformable table  
ML45 MT97





● T096 Mondial  
tavolino trasformabile  
transformable table  
ML45 MT98

● S208 Plio  
sedia pieghevole  
folding chair  
PL18 MT98

● X035 Soho  
specchio  
mirror  
X03 X04

● X500 DNA S - X501 DNA XS  
tavolini  
coffee tables  
CR21 MT98

● X403 Botticelle  
lampada soffitto  
ceiling lamp  
CR20



115x65 H. 23  
45.3"x25.6" H. 9"



130x115 H. 80  
51"x45.3" H. 31.5"



chiuso  
closed  
65  
25.6"

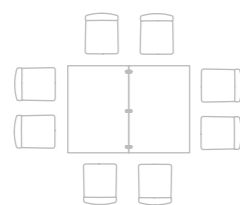

allungamento  
extensions  
130  
51"

● T097 Mondial CR  
| tavolino trasformabile - transformable table  
| MG03 MT97



# Planet

Design  
Studio Ozeta

Planet è un tavolino trasformabile elegante e discreto che si presenta in configurazione rettangolare. Le due allunghe celate sottopiano possono essere estratte singolarmente o in coppia, in grado di ospitare fino a 8 ospiti. La trasformazione del prodotto da tavolino a tavolo pranzo è facile e rapida per una nuova destinazione d'uso.

Planet is an elegant and discreet convertible coffee table in a rectangular configuration. The two hidden extensions under the top can be pulled out individually or in pairs, accommodating up to 8 guests. The transformation of the product from coffee table to dining table is easy and quick for a new use.

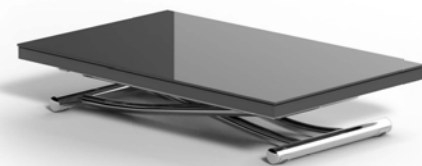

● **T115 Planet**  
tavolino trasformabile - transformable table  
CR04 MT92

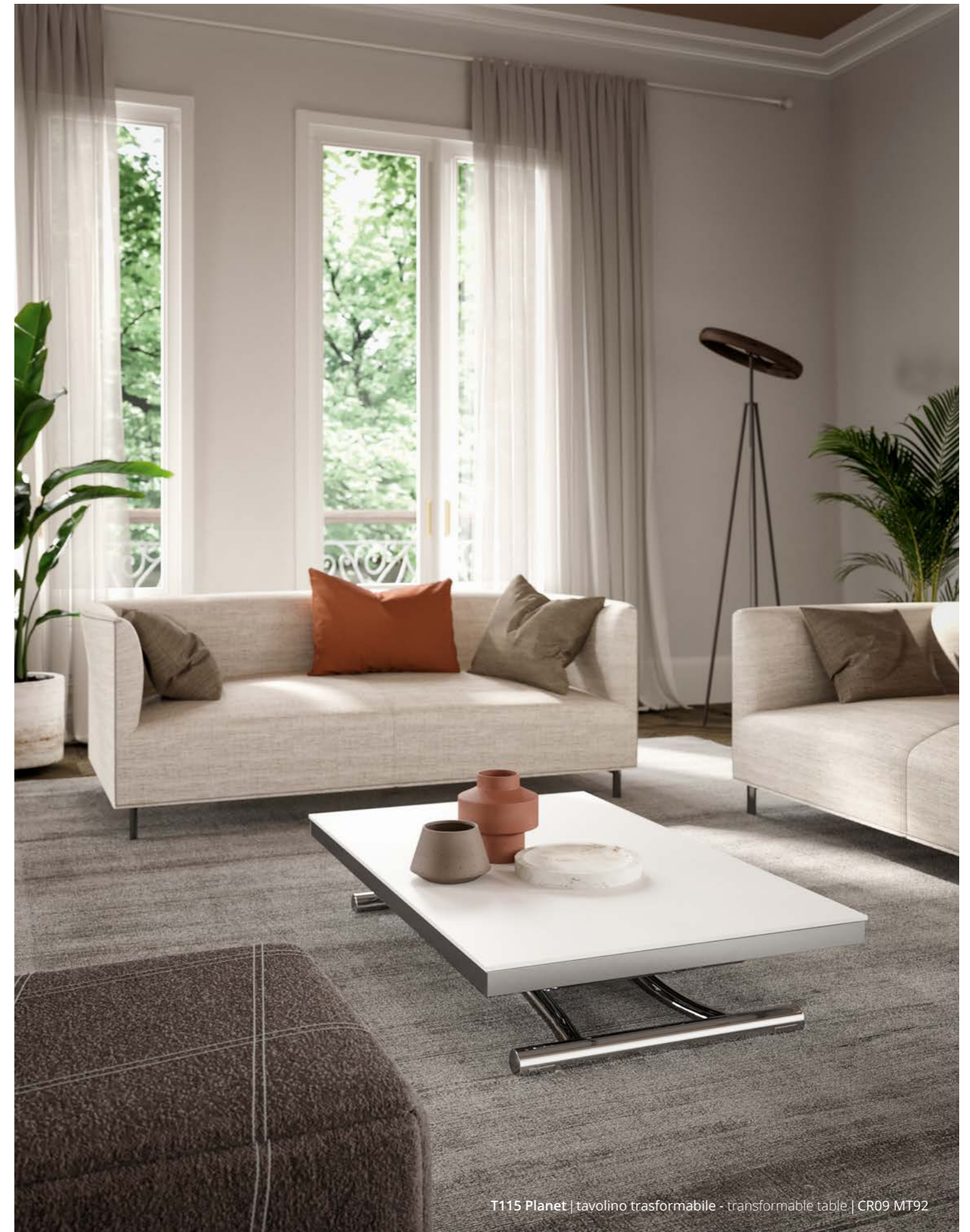

T115 Planet | tavolino trasformabile - transformable table | CR09 MT92



● **T115 Planet**  
tavolino trasformabile - transformable table  
CR09 MT92

● **S011 Cubix**  
pouf trasformabile - transformable pouf  
B03 MT97



● **T115 Planet**  
tavolino trasformabile - transformable table  
CR09 MT92



120x74 H. 23  
47.2"x29" H. 9"



196x74 H. 80  
77"x29" H. 31.5"



chiuso  
closed  
120  
47.2"

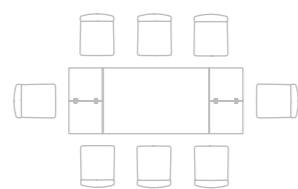

allungamenti  
extensions  
step 1 158 - 62.2"  
step 2 196 - 77"



● T115 Planet  
tavolino trasformabile - transformable table  
CR18 MT92

# Sydney Sydney CR

Design  
Toshiyuki Yoshino  
Studio Ozeta

Sydney e Sydney CR sono tavolini trasformabili polifunzionali dal segno metropolitano, estremamente attuali nelle finiture proposte in armonie di forme e colori. Strutturati con piano raddoppiabile a libro e basamento in metallo regolabile al millimetro, risultano pratici e versatili, oltre che perfetti per i piccoli spazi.

Sydney and Sydney CR are multifunctional convertible tables with a metropolitan look, extremely modern in their finishes, offered in harmonies of shapes and colours. Structured with a folding top and a metal base adjustable to the millimetre, they are practical and versatile, as well as perfect for small spaces.



● T128 Sydney CR  
tavolino trasformabile - transformable table  
MG02 MT98







● T128 Sydney CR  
tavolino trasformabile  
transformable table  
MG02 MT98

● S215 Ripiego  
sedia pieghevole  
folding chair  
PW96 MT97

● X402 Astrum  
lampada arco  
arc lamp  
PZ94 MT97

● X309 Brera TV  
madia  
sideboard  
PZ94 X06 MT98

● X038 Miami Vice  
specchio  
mirror  
MG05 MG02



Sydney  
100x60 H. 23  
39.3"x23.6" H. 9"

Sydney - Sydney CR  
115x65 H. 23  
45.2"x25.6" H. 9"



Sydney  
120x100 H. 76  
47.2"x39.3" H. 30"

Sydney - Sydney CR  
130x115 H. 76  
51"x45.2" H. 30"



Sydney  
chiuso  
closed  
60  
23.6"

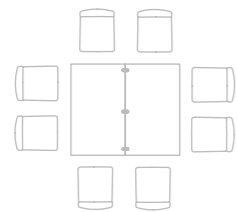

Sydney  
allungamento  
extension  
120  
47.2"



Sydney - Sydney CR  
chiuso  
closed  
65  
25.6"

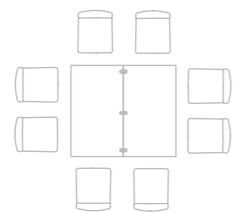

Sydney - Sydney CR  
allungamento  
extension  
130  
51"

● **T121 Sydney**  
| tavolino trasformabile - transformable table  
| ML46 MT97





# Cubix

Design  
Giulio Manzoni

Sorprendente, trasformabile, indispensabile, sono solo alcuni degli aggettivi che descrivono al meglio questo innovativo complemento. L'avveniristico studio di intersezioni cela all'interno cinque sedute, quattro delle quali progettate per essere utilizzate come comode sedie dotate di poggia schiena imbottito. Articolo insostituibile per la praticità di utilizzo, dotato di quattro ruote per una facile movimentazione oltre che a un elegante progetto di doppia cucitura per semplificare il riposizionamento in sede delle sedute.

Surprising, transformable, essential, are just some of the adjectives that best describe this innovative item. The futuristic study of intersections hides five chairs inside, four of which are comfortable chairs with upholstered backrests. A unique item easy to use, equipped with four sliding wheels for easy handling, and an elegant double stitching design to simplify the opening and closing system.



● S011 Cubix  
pouf trasformabile - transformable pouf  
EP90 MT97





● S011 Cubix  
pouf trasformabile - transformable pouf  
EP90 MT97



## La trasformabilità di Cubix Cubix transformability

01.



Pouf trasformabile dotato di rotelle per una facile movimentazione. Utilizzabile come seduta anche completamente "chiuso". L'elegante doppia cucitura semplifica il riposizionamento in sede delle quattro sedute interne.

Transformable pouf equipped with castors for easy handling. It can be used as a sitting when completely "closed". The elegant double stitching simplifies the repositioning of the four internal seats.

02.



L'estrazione delle sedute è pratica e intuitiva. È possibile utilizzare il numero di sedute desiderato, lasciando all'interno del pouf quelle che non risultano necessarie.

The extraction of the sittings is practical and intuitive. It is possible to use the number of sittings needed and leave the other ones stored inside the pouf.

03.



Le quattro sedute interne, una volta estratte, possono essere utilizzate anche senza l'ausilio dello schienale, ma come semplici sgabelli.

The four internal sittings, once extracted, can also be used without the backrest but as simple stools.

04.



Per un maggiore confort e completa libertà di utilizzo, le quattro sedute interne sono dotate di un morbido schienale imbottito. Mentre il pouf con rotelle può essere utilizzato anch'esso come seduta o come tavolino da appoggio.

For greater comfort and complete freedom of use, the four internal sittings are equipped with a padded backrest. While the pouf with castors can also be used as a stool or as a coffee table.



57x57 H. 53  
22.4"x22.4" H. 20.9"

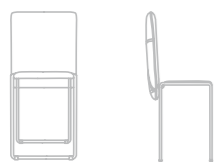

42x46 H. 82  
16.5"x18" H. 32.3"

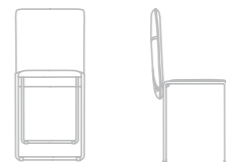

42,5x51 H. 83  
16.7"x20.5" H. 32.7"

● **S011 Cubix**  
pouf trasformabile - transformable pouf  
EP90 MT97

● **T110 Box**  
tavolino trasformabile - transformable table  
MG05 MT97



# Ripiego

Design  
Giuliano Cappelletti  
& Studio Ozeta

Elegante e salvaspazio, la seduta Ripiego è in grado di mimetizzarsi in solo 90 cm di altezza per 7 di spessore da chiusa. Le sue pregiate finiture in legno si sposano con la robusta struttura in metallo cromato o verniciato.

Elegant and space-saving, the Ripiego chair is able to blend into just 90 cm high by 7 thick when closed. Its precious wood and vitrex finishes are combined with the strong structure in chromed or painted metal.



● S215 Ripiego  
sedia pieghevole - folding chair  
PW96 MT97

S215 Ripiego | sedia pieghevole - folding chair | PW91 PW96 MT97



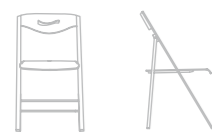

44,5x46 H. 77,5  
17.5"x18" H. 30.5"

● **S215 Ripiego**  
sedia pieghevole - folding chair  
PW96 MT97

● **T021 A4**  
consolle - console  
PZ94





# Plio

Design  
Marco Pozzoli & Studio Ozeta

Sedia pieghevole dal design fresco ed essenziale con struttura in metallo seduta e schienale in polipropilene. Il suo disegno lineare la rende complemento ideale per le versioni di tavoli "space saving" e per l'ambiente cucina pranzo informale.

Folding chair with a fresh and pure design, with metal structure and polypropylene seat and back. Its simple style makes it perfect for the "space saving" collection and for the casual kitchen living.



● S208 Plio  
sedia pieghevole - folding chair  
PL08 MT97



S208 Plio | sedia pieghevole - folding chair | PL01 PL08 PL18 MT61 MT97 MT98



44,5x46 H. 79,5  
17.5"x18" H. 31.3"

● S208 Plio  
sedia pieghevole - folding chair  
PL18 MT98

● T132 Ellis  
tavolino trasformabile - transformable table  
PW96





Consolle  
Console

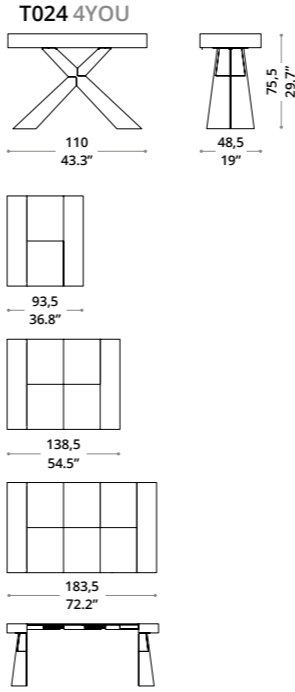

Design:  
Giulio Manzoni

Consolle allungabile dotata di 3 prolunghe incorporate nel piano. Meccanismo telescopico in alluminio, gambe in metallo. Piano e allunghe in legno.

Extendable console with 3 inside extensions. Aluminium telescopic mechanism, metal legs. Wooden top and extensions.



Fino a 10 posti  
Up to 10 seats

**STRUTTURA**  
STRUCTURE

Metallo - Metal



**PIANO E ALLUNGHE**  
TOP AND EXTENSIONS

Legno - Wood



Tutti i prodotti sono brevettati  
Our products are all patented

**LEGENDA**  
LEGEND



Numero massimo commensali consigliati  
Number of seats suggested



Articolo dotato di rotelle  
Equipped with castors

\*Tutte misure sono espresse in cm e pollici  
All dimensions are expressed in cm and inches

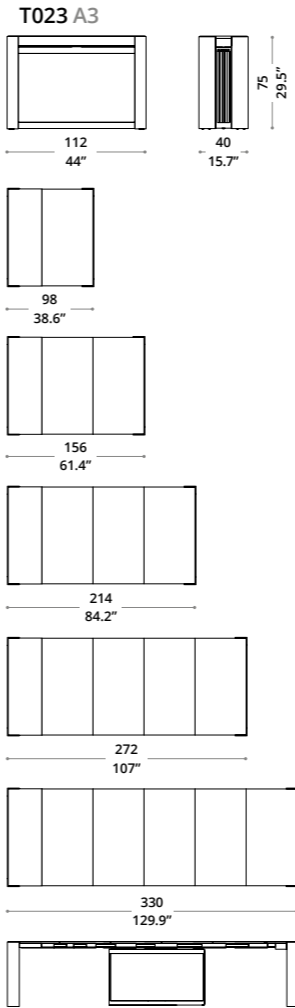

Design:  
Marco Pozzoli - Giacomo Mauri

Consolle allungabile dotata di 5 prolunghe incorporate nella struttura. Meccanismo telescopico in alluminio, gamba centrale girevole per supporto a meccanismo aperto, ruote per una facile movimentazione. Sistema di bloccaggio delle gambe anteriori.

Extendable wooden console with 5 extensions placed in the structure. Aluminum telescopic mechanism with swivelling central leg supporting the mechanism while open. Castors under the legs to simplify the movement. Locking system positioned on front legs.



Fino a 14 posti  
Up to 14 seats



Dotato di rotelle  
Equipped with castors

**GAMBA GIREVOLE**  
PORTA ALLUNGHE  
SWIVELLING  
HOLDER LEG

Metallo - Metal



**STRUTTURA E PIANO**  
STRUCTURE AND TOP

Legno - Wood



# Consolle

## Console

### T021 A4

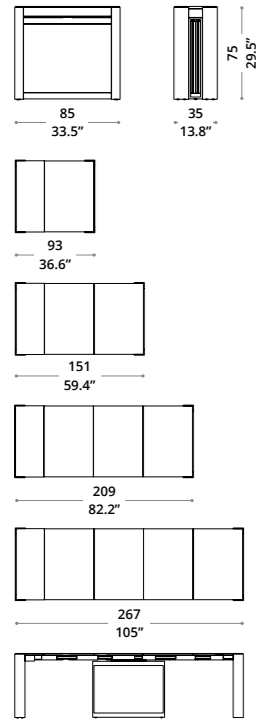

Design:  
Marco Pozzoli - Giacomo Mauri

Consolle allungabile dotata di 4 prolunghe incorporate nella struttura. Meccanismo telescopico in alluminio, gamba centrale girevole per supporto a meccanismo aperto, ruote per una facile movimentazione.

Extendable wooden console with 4 extensions placed in the structure. Aluminium telescopic mechanism with swivelling central leg supporting the mechanism while open. Castors under the legs to simplify the movement.



Fino a 10 posti  
Up to 10 seats



Dotato di rotelle  
Equipped with castors

#### GAMBA GIREVOLE PORTA ALLUNGHE SWIVELLING HOLDER LEG

Metallo - Metal

MT98

#### STRUTTURA E PIANO STRUCTURE AND TOP

Legno - Wood



### T035 GOLIA

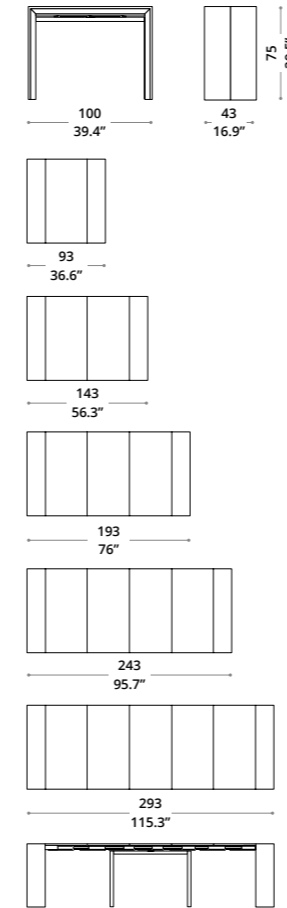

Design:  
Marco Pozzoli - Giacomo Mauri

Consolle allungabile con piani, gambe e allunghe in legno. Meccanismo telescopico in alluminio e dotata di 5 prolunghe esterne di 50 cm. Gamba centrale girevole, con finitura in tinta.

Extendable console with wooden top, legs and extensions. Aluminium telescopic mechanism. 5 external extensions 50 cm each. Swivelling central leg, with matching finishing.



Fino a 12 posti  
Up to 12 seats

#### PIANO, ALLUNGHE E GAMBE TOP, EXTENSIONS AND LEGS

Legno - Wood



Laccato poro aperto - Lacquered open pores



### T031 CO4L

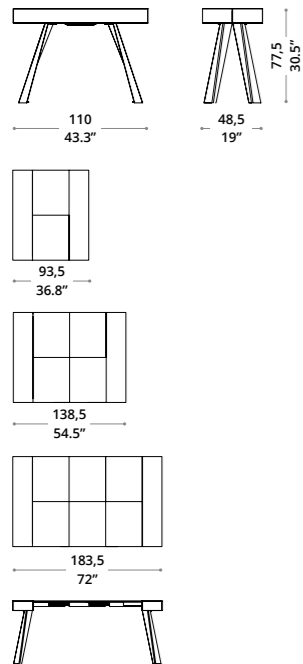

Design:  
Giulio Manzoni

Consolle allungabile dotata di 3 prolunghe incorporate nel piano. Meccanismo telescopico in alluminio, gambe in metallo. Piano e allunghe in legno.

Extendable console with 3 inside extensions. Aluminium telescopic mechanism, metal legs. Wooden top and extensions.



Fino a 10 posti  
Up to 10 seats

#### STRUTTURA STRUCTURE

Metallo - Metal

MT98 MT97

#### PIANO E ALLUNGHE TOP AND EXTENSIONS

Legno - Wood



### T029 MINUX

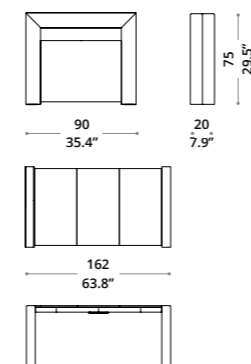

Design:  
Marco Pozzoli

Consolle allungabile con meccanismo in alluminio. Struttura, piano e 3 allunghe (19 mm) in finitura legno o laccato. Allunghe contenute nella struttura. Consolle con ingombro minimo di soli 20 cm.

Extendable console with aluminium mechanism. Structure, top and 3 extensions (19 mm) in wood or lacquered. Extensions inside the structure. The depth of the console is only 20 cm.



Fino a 8 posti  
Up to 8 seats

#### PIANO, ALLUNGHE E GAMBE TOP, EXTENSIONS AND LEGS

Legno - Wood



Laccato poro aperto - Lacquered open pores

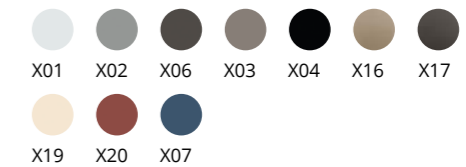

## Tavolini multifunzione

### Multifunctional coffee-table

#### T067 AURELIUS

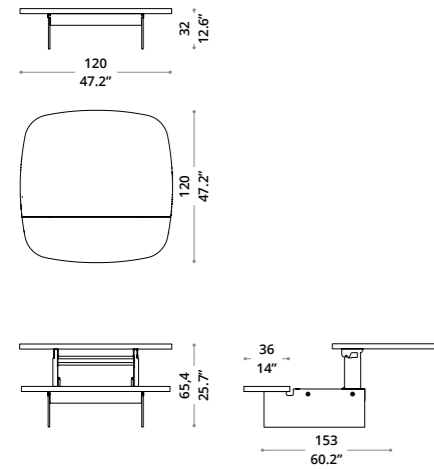

Design:  
Marco Pozzoli

Tavolino trasformabile a 2 altezze (cm 32>cm 65,4), struttura in metallo, piano in legno, gambe in cristallo, top con meccanismo di sollevamento a gas auto-frenante.

Two-heights (cm 32>cm 65,4) transformable coffee-table with metal structure, wooden top and glass feet. Self-braking gas-lifting device.

#### STRUTTURA STRUCTURE

Metallo - Metal



#### GAMBE LEGS

Cristallo - Glass

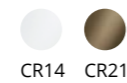

#### PIANO TOP

Legno - Wood

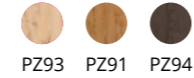

#### T063 MARKUS

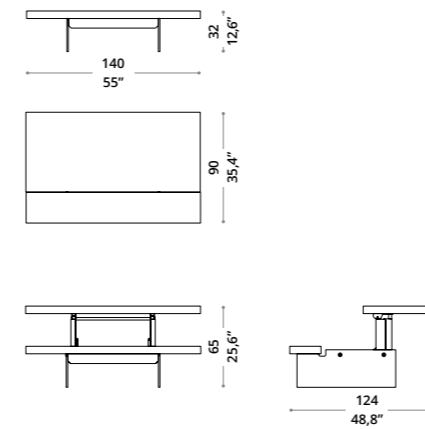

Design:  
Marco Pozzoli

Tavolino trasformabile a 2 altezze (cm 32>cm 65), struttura in metallo, piano e seduta in legno, gambe in cristallo, top con meccanismo di sollevamento a gas auto-frenante. Una volta sollevato, parte del piano diventa panca.

Two-heights (cm 32>cm 65) transformable coffee-table with metal structure, wooden top and glass feet. Self-braking gas-lifting device. Once opened, a part of the top become a bench.

#### STRUTTURA STRUCTURE

Metallo - Metal



#### GAMBE LEGS

Cristallo - Glass

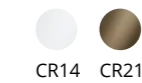

#### PIANO TOP

Legno - Wood

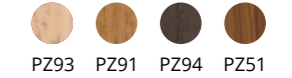

#### T059 BELL

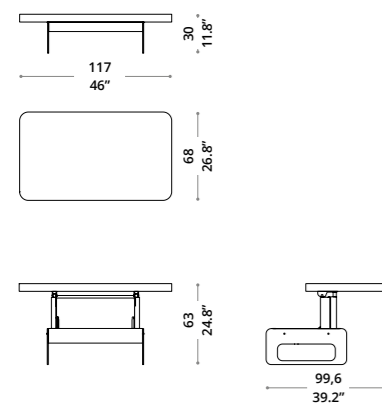

Design:  
Marco Pozzoli  
Studio Tonelli & Carlesi

Tavolino trasformabile a 2 altezze (cm 30>cm 63), struttura in metallo, piano con meccanismo di sollevamento a gas auto-frenante.

Two-heights (cm 30>cm 63) transformable coffee-table with metal structure. Selfbraking gas-lifting device.

#### STRUTTURA STRUCTURE

Metallo - Metal



#### GAMBE LEGS

Metallo - Metal



#### PIANO TOP

Legno - Wood

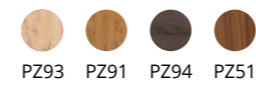

#### T062 METRINO

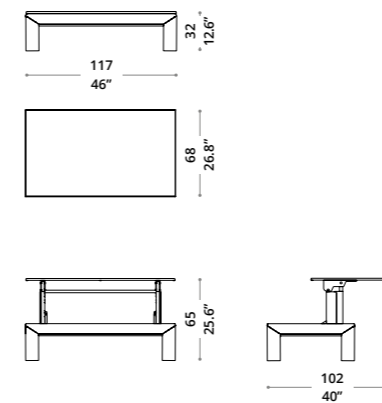

Design:  
Marco Pozzoli - Giacomo Mauri

Tavolino trasformabile a 2 altezze (cm 32>cm 65), struttura in metallo, piano in legno, meccanismo di sollevamento a gas auto-frenante.

Two-heights (cm 32>cm 65) transformable coffee-table with metal structure and wooden top. Self-braking gas-lifting device.

#### STRUTTURA STRUCTURE

Metallo - Metal

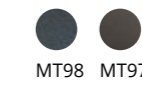

#### PIANO TOP

Legno - Wood



#### T061 BELLAGIO

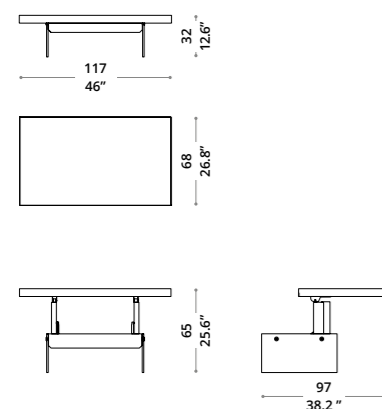

Design:  
Marco Pozzoli

Tavolino trasformabile a 2 altezze (cm 32>cm 65), struttura in metallo, piano con meccanismo di sollevamento a gas auto-frenante. Gambe in cristallo.

Two-heights (cm 32>cm 65) transformable coffee-table with metal structure. Glass feet. Selfbraking gas-lifting device.

#### STRUTTURA STRUCTURE

Metallo - Metal



#### GAMBE LEGS

Cristallo - Glass

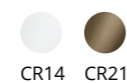

#### PIANO TOP

Legno - Wood

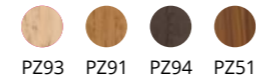

Cemento - Cement

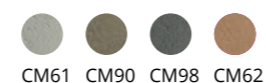

Marble Glass

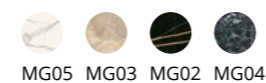

#### T064 RADIUS

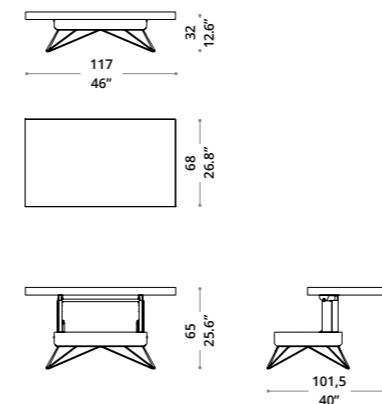

Design:  
Marco Pozzoli

Tavolino trasformabile a 2 altezze (cm 32>cm 65), struttura e gambe in metallo, piano in legno, cemento o Marble Glass. Meccanismo di sollevamento a gas auto-frenante.

Two-heights (cm 32>cm 65) transformable coffee-table with metal structure and legs. Wooden, cement or Marble Glass top. Selfbraking gas-lifting device.

#### STRUTTURA E GAMBE STRUCTURE AND LEGS

Metallo - Metal



#### PIANO TOP

Legno - Wood



Cemento - Cement

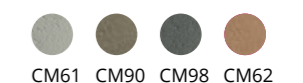

Marble Glass



## Tavolini multifunzione Multifunctional coffee-table

### T058 ZOOM

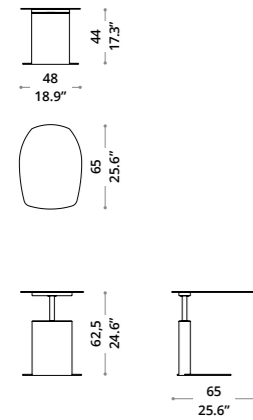

Design:  
Marco Pozzoli - Andrea Lucatello

Tavolino fianco divano regolabile in altezza. Piano in metallo sagomato. Base in metallo verniciato bronzo o grafite. Sistema esclusivo a pistone a gas frenato.

Height adjustable sofa side table. Shaped metal top. Metal structure bronze or graphite coating. Exclusive gas-braking piston system.

#### PIANO, BASE E COLONNA TOP, BASE AND COLUMN

Metallo - Metal



MT98 MT97

#### VASSOIO (OPTIONAL) TRAY (OPTIONAL)

Legno - Wood



PW61 PW91 PW96 PW97 PW94

con vassoio - with tray

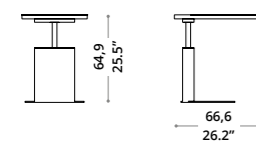
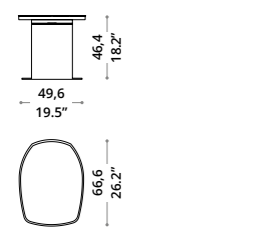

sezione vassoio - tray section

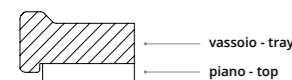

## Tavolini trasformabili Transformable table

### T110 BOX

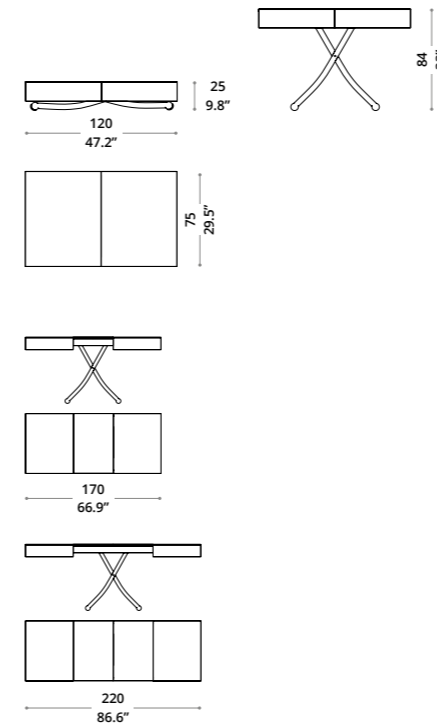

Design:  
Studio Ozeta

Tavolino trasformabile diventa tavolo da pranzo. Base metallo con ruote e alzata con pistone a gas. Regolabile in tutte le altezze al millimetro. Allunghe interne in nobilitato. Apertura telescopica sincronizzata.

Transformable couch table; it turns into a dining table. Metal structure with castors, gas lifting device. Adjustable at any height, inside painted melamine extensions. Synchronised telescopic extension mechanism.



Fino a 10 posti  
Up to 10 seats



Dotato di rotelle  
Equipped with castors

#### STRUTTURA STRUCTURE

Metallo - Metal



MT92 MT98 MT97

#### PIANO TOP

Cristallo - Glass



CR01

Cristallo antimpronta - Mark-less glass



CR09

Marble Glass



MG05 MG03 MG02 MG04

### T111 BOX LEGNO

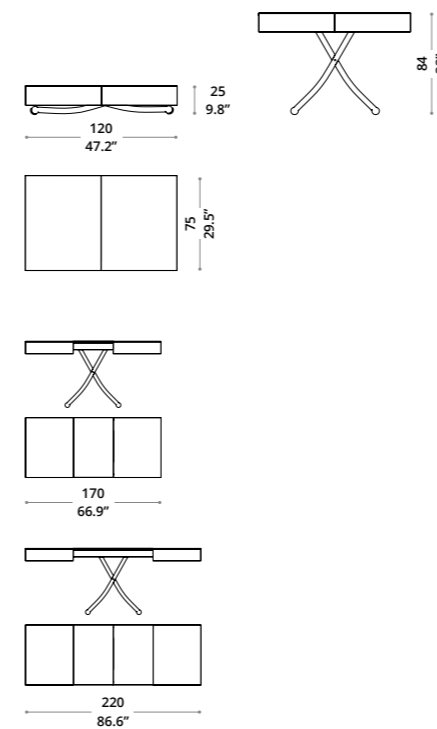

Design:  
Studio Ozeta

Tavolino trasformabile diventa tavolo da pranzo. Base metallo con ruote e alzata con pistone a gas. Regolabile in tutte le altezze al millimetro. Allunghe interne in tinta con il piano. Apertura telescopica sincronizzata.

Transformable couch table; it turns into a dining table. Metal structure with castors, gas lifting device. Adjustable at any height. Wooden inside extensions matching with the top. Synchronised telescopic extension mechanism.



Fino a 10 posti  
Up to 10 seats



Dotato di rotelle  
Equipped with castors

#### STRUTTURA STRUCTURE

Metallo - Metal



MT92 MT98 MT97

#### PIANO TOP

Legno - Wood



PW61 PW91 PW96 PW97 PW94

Cemento - Cement



CM61 CM90 CM98 CM62

## Tavolini trasformabili

### Transformable table

#### T132 ELLIS

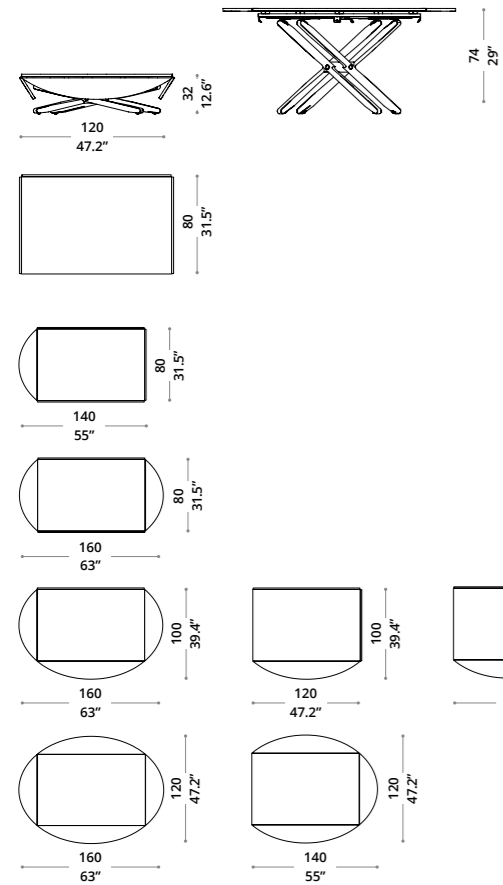

Design:  
Giulio Manzoni

Tavolino trasformabile diventa tavolo da pranzo. Piano allungabile in 8 posizioni. Piano, allunghe e gambe in legno e alzata con pistone a gas. Regolabile in tutte le altezze al millimetro.

Transformable couch table; it turns into a dining table. Extendable top in 8 positions. Top, extensions and legs in wood, gas lifting device. Adjustable at any height.



Fino a 8 posti  
Up to 8 seats



Dotato di rotelle  
Equipped with castors

#### PIANO E GAMBE TOP AND LEGS

Legno - Wood



#### T129 LEONARDO

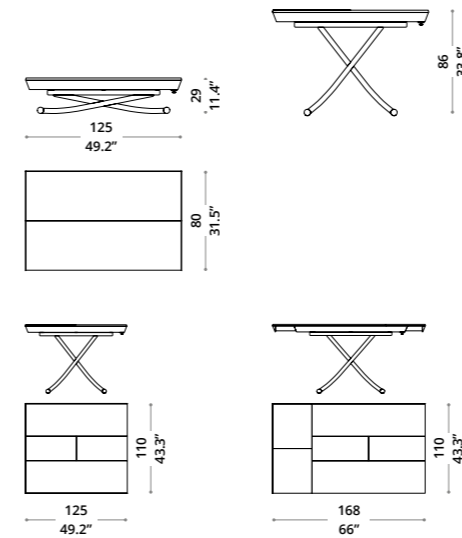

Design:  
Marco Pozzoli

Tavolino trasformabile diventa tavolo da pranzo. Base metallo con ruote e alzata con pistone a gas. Regolabile in tutte le altezze al millimetro.

Transformable couch table; it turns into a dining table. Metal structure with castors, gas lifting device. Adjustable at any height.



Fino a 10 posti  
Up to 10 seats



Dotato di rotelle  
Equipped with castors

#### STRUTTURA STRUCTURE

Metallo - Metal

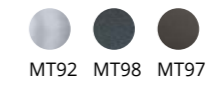

#### PIANO E ALLUNGHE TOP AND EXTENSIONS

Legno - Wood



#### T096 MONDIAL

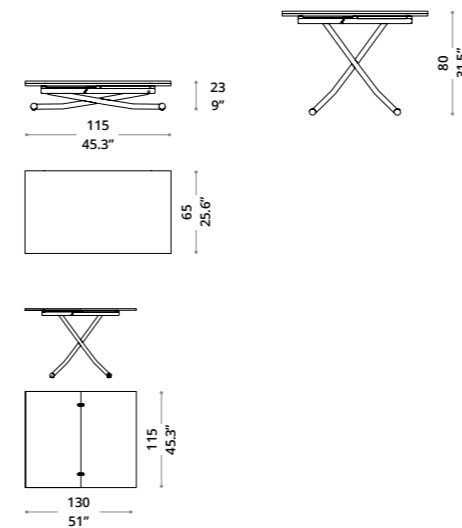

Design:  
Studio Ozeta

Tavolino trasformabile diventa tavolo da pranzo. Piano raddoppiabile a libro. Base metallo con ruote e alzata con pistone a gas. Regolabile in tutte le altezze al millimetro.

Transformable couch table; it turns into a dining table. Folding doubling top. Metal structure with castors, gas lifting device. Adjustable at any height.



Fino a 8 posti  
Up to 8 seats



Dotato di rotelle  
Equipped with castors

#### STRUTTURA STRUCTURE

Metallo - Metal



#### PIANO TOP

Eco legno - Eco wood



#### T133 JOLLY

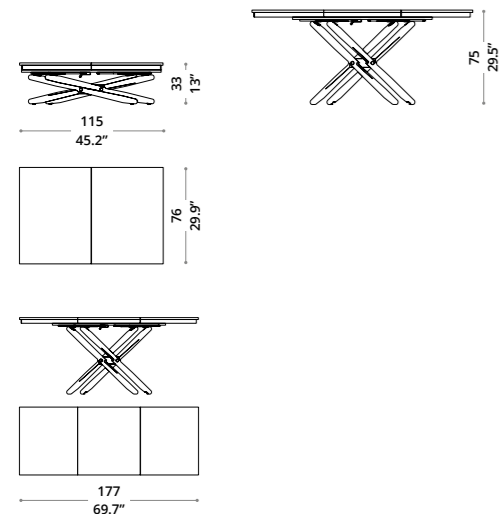

Design:  
Giulio Manzoni

Tavolino trasformabile diventa tavolo da pranzo. Piano, allunghe e gambe in legno, dotato di ruote e alzata con pistone a gas. Regolabile in tutte le altezze al millimetro.

Transformable couch table; it turns into a dining table. Wooden top, extensions and legs, gas lifting device. Adjustable at any height.



Fino a 8 posti  
Up to 8 seats



Dotato di rotelle  
Equipped with castors

#### PIANO E GAMBE TOP AND LEGS

Legno - Wood



#### T097 MONDIAL CR

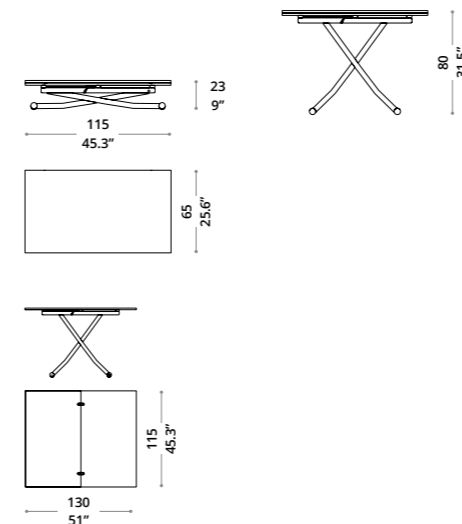

Design:  
Studio Ozeta

Tavolino trasformabile diventa tavolo da pranzo. Piano raddoppiabile a libro in cristallo o Marble Glass. Base metallo con ruote e alzata con pistone a gas. Regolabile in tutte le altezze al millimetro.

Transformable couch table; it turns into a dining table. Glass or Marble Glass folding doubling top. Metal base with castors, gas lifting device. Adjustable at any height.



Fino a 8 posti  
Up to 8 seats



Dotato di rotelle  
Equipped with castors

#### STRUTTURA STRUCTURE

Metallo - Metal



#### PIANO TOP

Cristallo - Glass



Cristallo antimpronta - Mark-less glass



Marble Glass

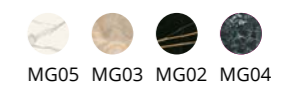



# Tavolini trasformabili

## Transformable table

### T123 NEWOOD

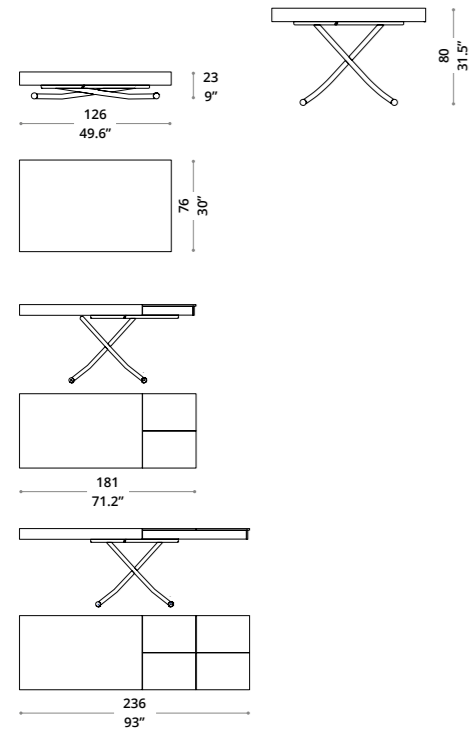

Design:  
Studio Ozeta

Tavolino trasformabile diventa tavolo da pranzo, base in metallo con ruote, meccanismo a gas regolabile al millimetro in altezza da cm 23 a cm 80, sistema di apertura telescopica sincronizzata delle allunghe.

Transformable couch table it turns into a dining table. Metal structure with castors, gas adjustable height from cm 23 to cm 80, synchronised telescopic extension mechanism.



Fino a 10 posti  
Up to 10 seats



Dotato di rotelle  
Equipped with castors

#### STRUTTURA STRUCTURE

Metallo - Metal

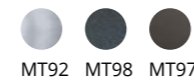

#### PIANO E ALLUNGHE TOP AND EXTENSIONS

Legno - Wood



Cemento - Cement

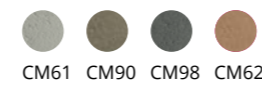

### T115 PLANET

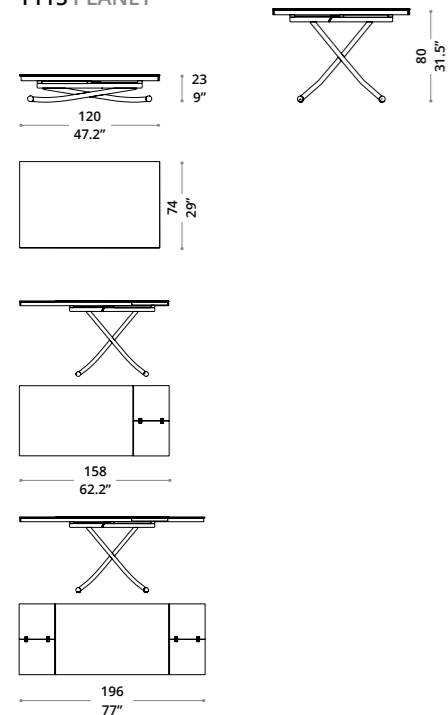

Design:  
Studio Ozeta

Tavolino trasformabile diventa tavolo da pranzo. Base in metallo con ruote e alzata con pistone a gas. Regolabile in tutte le altezze al millimetro. Allunghe in nobilitato.

Transformable couch table; it turns into a dining table. Metal base with castors, gas lifting device. Adjustable at any height, melamine extensions.



Fino a 8 posti  
Up to 8 seats



Dotato di rotelle  
Equipped with castors

#### STRUTTURA STRUCTURE

Metallo - Metal



#### PIANO TOP

Cristallo - Glass



Cristallo antimpronta - Mark-less glass



### T101 SU E GIÙ

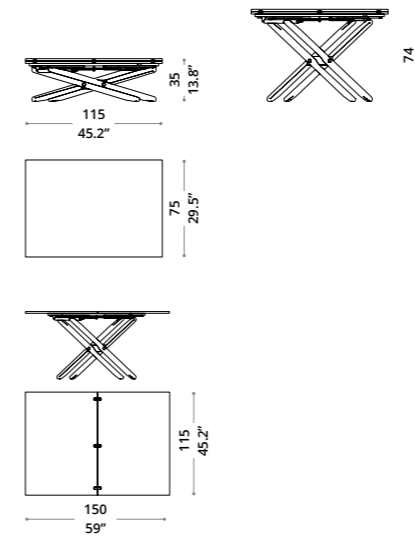

Design:  
Giulio Manzoni

Tavolino trasformabile diventa tavolo da pranzo. Piano raddoppiabile a libro. Base in legno e alzata con pistone a gas. Regolabile in tutte le altezze al millimetro.

Transformable couch table; it turns into a dining table. Folding doubling top. Wooden structure and gas lifting device. Adjustable at any height.



Fino a 8 posti  
Up to 8 seats



Dotato di rotelle  
Equipped with castors

#### PIANO E GAMBE TOP AND LEGS

Legno - Wood



### T121 SYDNEY

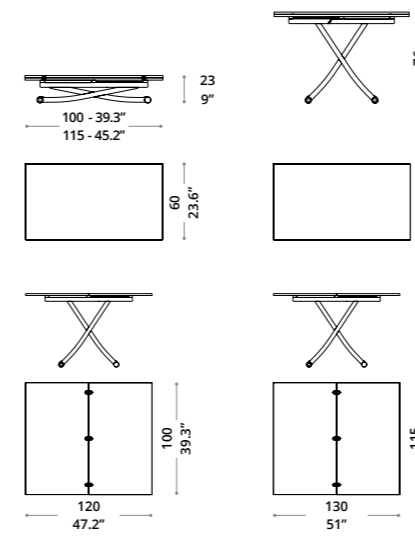

Design:  
Studio Ozeta - Yoshino Toshiyuki

Tavolino trasformabile diventa tavolo da pranzo, base in metallo con ruote, meccanismo a gas regolabile al millimetro in altezza da cm 23 a cm 76, piano raddoppiabile a libro in eco legno. Disponibile in due dimensioni di piano.

Transformable couch table it turns into a dining table. Metal structure with castors, gas adjustable height from cm 23 to cm 76, ecowood doubling top. Available in two top sizes.



Fino a 8 posti  
Up to 8 seats



Dotato di rotelle  
Equipped with castors

#### STRUTTURA STRUCTURE

Metallo - Metal



#### PIANO TOP

Eco legno - Eco wood



### T128 SYDNEY CR

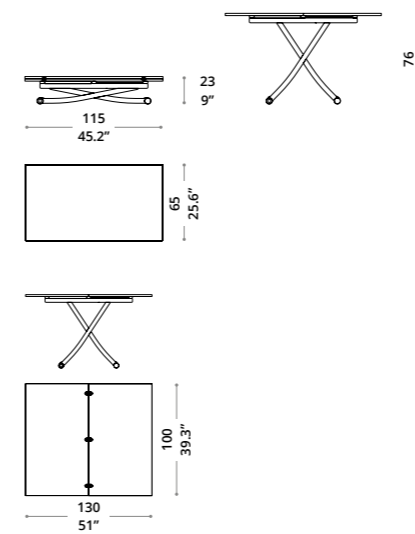

Design:  
Studio Ozeta - Yoshino Toshiyuki

Tavolino trasformabile diventa tavolo da pranzo, base in metallo con ruote, meccanismo a gas regolabile al millimetro in altezza da cm 23 a cm 76, piano raddoppiabile a libro in vetro o Marble Glass.

Transformable couch table; it turns into a dining table. Glass or Marble Glass folding doubling top. Metal base with castors, gas lifting device. Adjustable at any height.



Fino a 8 posti  
Up to 8 seats



Dotato di rotelle  
Equipped with castors

#### STRUTTURA STRUCTURE

Metallo - Metal



#### PIANO TOP

Cristallo - Glass



Cristallo antimpronta - Mark-less glass



Marble Glass

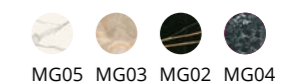

# Sedute Seat

## S011 CUBIX

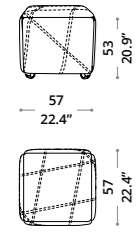

### 2 sedie piccole - 2 small chairs

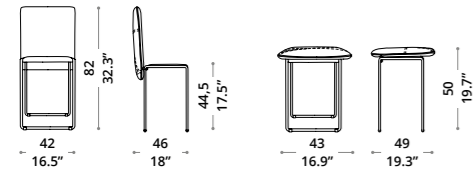

schienale aperto  
open backrest

schienale chiuso  
closed backrest

### 2 sedie grandi - 2 big chairs

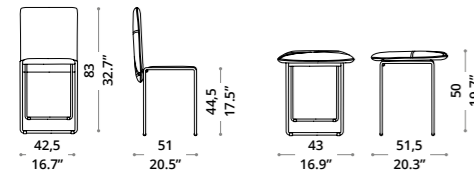

schienale aperto  
open backrest

schienale chiuso  
closed backrest

### sgabello - stool

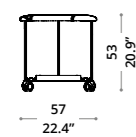

Design:  
Giulio Manzoni

Pouf rivestito contenente al suo interno 4 sedie pieghevoli con seduta e poggia schiena imbottito. Consente di ottenere 5 sedute. Dotato di quattro ruote per una facile movimentazione.

Upholstered pouf containing 4 folding chairs with padded seat and backrest. It allows to get 5 sittings. Equipped with four castors for easy handling.



Dotato di rotelle  
Equipped with castors

### STRUTTURA STRUCTURE

Metallo - Metal



MT97

### SEDUTA E SCHIENALE SEAT AND BACK

Eco pelle - Soft eco leather



EP03 EP15 EP90 EP14 EP13



EP18 EP04

Velvet



VE03 VE05 VE02 VE04 VE01



VE07

Bouclè



B01 B02 B03 B04 B05

## S215 RIPIEGO

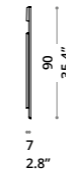
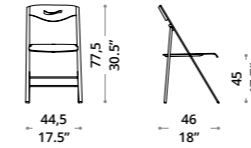

Design:  
Giuliano Cappelletti  
& Studio Ozeta

Sedia pieghevole con struttura in metallo, seduta e schienale in legno.

Metal frame folding chair, wooden seat and backrest.

### STRUTTURA STRUCTURE

Metallo - Metal



MT92 MT98 MT97

### SEDUTA E SCHIENALE SEAT AND BACK

Legno - Wood



PW61 PW91 PW96 PW97 PW94

## S208 PLIO

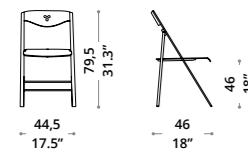

Design:  
Marco Pozzoli & Studio Ozeta

Sedia pieghevole con struttura in metallo, seduta e schienale in polipropilene.

Metal frame folding chair polypropylene seat and back.

### STRUTTURA STRUCTURE

Metallo - Metal

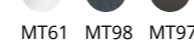

MT61 MT98 MT97

### SEDUTA E SCHIENALE SEAT AND BACK

Metallo - Metal

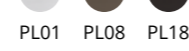

PL01 PL08 PL18

Finiture  
Finishes

LEGNI  
WOOD



**PW61**  
Rovere wild bianco  
Wild white oak



**PW91**  
Rovere wild naturale  
Wild natural oak



**PW96**  
Rovere wild delhi  
Wild delhi oak



**PW97**  
Rovere wild tabacco  
Wild tabacco oak



**PW94**  
Rovere wild carbone  
Wild carbone oak



**PZ93**  
Rovere vecchio soft  
Soft ancient oak



**PZ91**  
Rovere vecchio naturale  
Natural ancient oak



**PZ94**  
Rovere vecchio dark grey  
Dark grey ancient oak



**PZ51**  
Noce canaletto  
Canaletto walnut

ECO LEGNO  
ECO WOOD



**ML52**  
Bianco spatolato  
Spalted white



**ML39**  
Beton  
Beton



**ML50**  
Pietra  
Stone



**ML92**  
Vecchio antico  
Ancient old



**ML44**  
Carbone  
Carbone



**ML43**  
Noce canaletto  
Canaletto walnut



**ML46**  
Rovere palude  
Palude oak



**ML45**  
Rovere grigio  
Grey oak

CEMENTI  
CEMENTS



**CM61**  
Grigio  
Grey

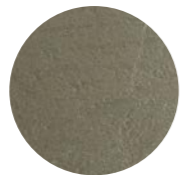

**CM90**  
Tortora  
Tortora

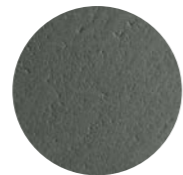

**CM98**  
Grafite  
Graphite



**CM62**  
Terra  
Terra

CRISTALLO  
GLASS



**CR14**  
Trasparente  
Transparent



**CR17**  
Float  
Float

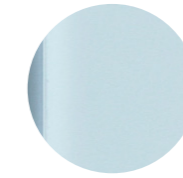

**CR01**  
Extrachiaro  
Extrawhite



**CR16**  
Crema caffè  
Coffee cream



**CR04**  
Antracite  
Anthracite



**CR08**  
Nero  
Black



**CR21**  
Bronzo  
Bronze



**VS01**  
Specchio bronze  
Bronze mirror



**VS02**  
Specchio fumè  
Fumè mirror

ANTIMPRONTA | MARK-LESS

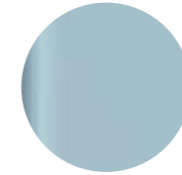

**CR09**  
Antimpronta Bianco  
Mark-less white

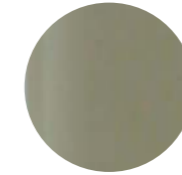

**CR19**  
Antimpronta crema caffè  
Mark-Less coffee cream



**CR18**  
Antimpronta grafite  
Mark-less graphite

VETRO  
BOCCIARDATO  
BUSH HAMMERED  
GLASS

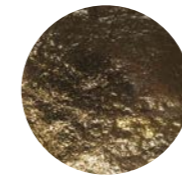

**VB01**  
Bronzo silver  
Bronze silver



**VB02**  
Fumè silver  
Fumè silver

CRISTALLO BORO  
BORO GLASS



**CR14**  
Trasparente  
Transparent

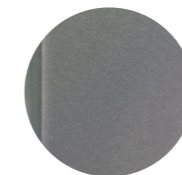

**CR22**  
Fumè Iri  
Fumè Iri

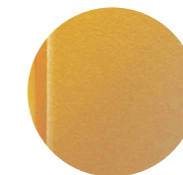

**CR20**  
Ambra Iri  
Ambra Iri

MARBLE GLASS

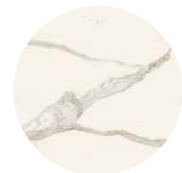

**MG05**  
Calacatta gold lucido  
Glossy Calacatta gold



**MG03**  
Onice lucido  
Glossy onice



**MG02**  
Sahara noir lucido  
Glossy Sahara noir

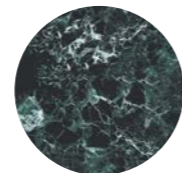

**MG04**  
Verde Alpi lucido  
Glossy verde Alpi

CERAMICA  
PYROCERAMIC

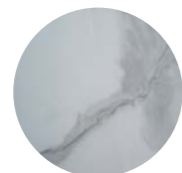

**CC07**  
Calacatta  
Calacatta

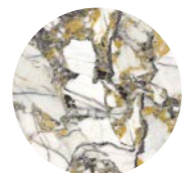

**CC11**  
Gold beauty  
Gold beauty

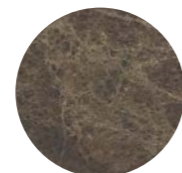

**CC10**  
Emperador  
Emperador



**CC08**  
Noir desir  
Noir desir

LACCATI  
LACQUERS



**X01**  
Inverno  
Inverno

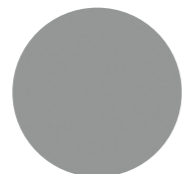

**X02**  
Pomice  
Pomice

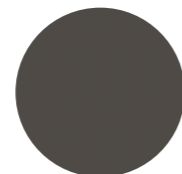

**X06**  
Ardesia  
Ardesia

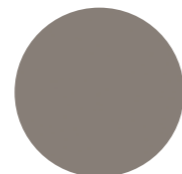

**X03**  
Cemento  
Cemento

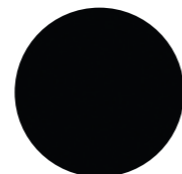

**X04**  
Nero  
Black



**X16**  
Champagne  
Champagne



**X17**  
Bronzo  
Bronze

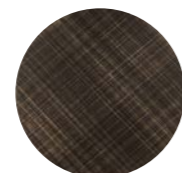

**X18**  
Bronzo Seta  
Silk Bronze



**X19**  
Avorio  
Ivory

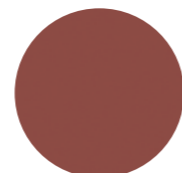

**X20**  
Granata  
Garnet

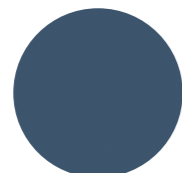

**X07**  
Avio  
Avio

VELVET  
VELVET



**VE03**  
Castoro  
Beaver



**VE05**  
Corda  
Rope



**VE02**  
Grigio  
Grey



**VE04**  
Smeraldo  
Emerald



**VE01**  
Rosa  
Pink



**VE07**  
Ruggine  
Rust

BOUCLÈ  
BOUCLÈ



**B01**  
Burro  
Butter



**B02**  
Liquirizia  
Liquorice



**B03**  
Bruno  
Dark Brown

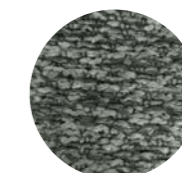

**B04**  
Basalto  
Basalt

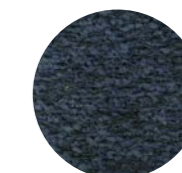

**B05**  
Blu oltremare  
Ultramarine Blue

CUOIO  
LEATHER



**C10**  
Bianco  
White



**C30**  
Crema caffè  
Coffee cream



**C25**  
Seta grigia  
Grey silk



**C32**  
Piombo  
Piombo

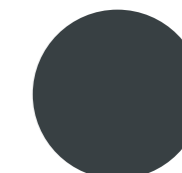

**C18**  
Grafite  
Graphite

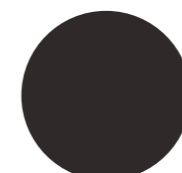

**C11**  
Moka  
Moka



**C09**  
Nero  
Black

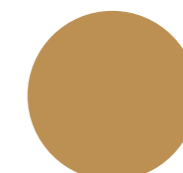

**C14**  
Naturale  
Natural

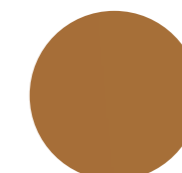

**C31**  
Khaki  
Khaki

**ECO PELLE**  
SOFT ECO LEATHER



**EP03**  
Bianco  
White



**EP15**  
Crema caffè  
Coffee cream



**EP90**  
Fango  
Fango



**EP14**  
Mastice  
Mastice



**EP13**  
Moka  
Moka



**EP18**  
Grafite  
Graphite



**EP04**  
Nero  
Black

**NABUK | NABUK**

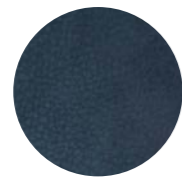

**EP56**  
Nabuk blu  
Natural blue



**EP57**  
Nabuk lince  
Nabuk lynce

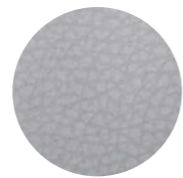

**EP51**  
Nabuk bianco  
Nabuk white



**EP52**  
Nabuk crema caffè  
Nabuk coffee cream



**EP54**  
Nabuk ghiaccio  
Nabuk ice

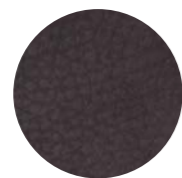

**EP50**  
Nabuk grigio  
Nabuk Grey

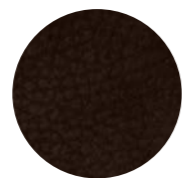

**EP55**  
Nabuk moka  
Nabuk moka

**PELLE**  
SOFT LEATHER



**P01**  
Bianco  
White



**P19**  
Polvere  
Polvere

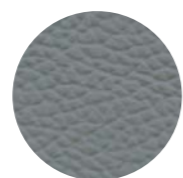

**P05**  
Cenere  
Ash



**P11**  
Mastice  
Mastice



**P18**  
Grafite  
Graphite



**P04**  
Ecrú  
Ecrú



**P20**  
Havana  
Havana



**P90**  
Fango  
Fango



**P10**  
Moka  
Moka



**P02**  
Nero  
Black

**POLIPROPILENE**  
POLYPROPYLENE



**PL01**  
Bianco  
White



**PL08**  
Bronzo  
Bronze

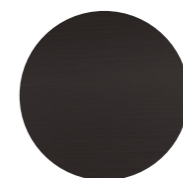

**PL18**  
Grafite  
Graphite

**METALLI**  
METALS

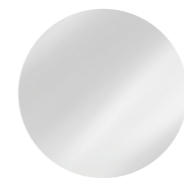

**MT61**  
Bianco lucido  
High gloss white



**MT92**  
Cromo  
Chrome

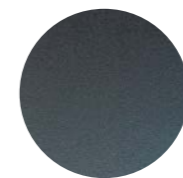

**MT98**  
Grafite opaco  
Matt graphite



**MT16**  
Champagne  
Champagne



**MT97**  
Bronzo  
Bronze



**MT12**  
Nero opaco  
Matt black



Concept & A.D.: Arch. Lara Santin

Images: Nerokubo

Progetto grafico: Monica Ferretti - Intodesign

Stampa: Grafiche Antiga



POZZOLI GROUP srl licenziataria del marchio OZZIO ITALIA si riserva il diritto di apportare, senza preavviso, ogni modifica volta al miglioramento funzionale e qualitativo dei prodotti. Le informazioni e i disegni rappresentati in questo catalogo, oltre ad avere carattere puramente illustrativo sono suscettibili di variazioni. I campioni di colori e materiali presentati in questo stampato hanno un valore indicativo compatibilmente con i limiti di riproduzione e stampa.

© PROPRIETÀ DI POZZOLI GROUP srl - TUTTI I DIRITTI RISERVATI - I marchi e gli altri segni distintivi, i testi, le fotografie, i disegni ed i modelli, i prodotti e gli altri materiali riportati nella presente brochure e tutti i diritti di proprietà intellettuale ed industriale ad essi relativi costituiscono proprietà riservata di POZZOLI GROUP srl. È vietata la loro riproduzione, copia, imitazione, pubblicazione, diffusione, distribuzione, elaborazione e qualsiasi uso, anche parziale, nella pubblicità, sui prodotti, confezioni, materiali illustrativi o pubblicitari, siti internet, nelle attività di marketing e commerciali ed ogni altro uso, senza la preventiva autorizzazione scritta di POZZOLI GROUP srl.

OZZIO ITALIA brand of POZZOLI GROUP srl reserves the right to change, without notice, any modification to the improvement functional and quality of the products. The information and drawings in this catalog, as well as have purely illustrative are subject to change. Samples of colors and materials presented in this publication are indicative consistent with the limitations of reproduction and printing.

© PROPERTIES OF POZZOLI GROUP srl - ALL RIGHTS RESERVED - Trademarks and other distinctive signs, texts, photographs, drawings and models, products and other materials contained in this brochure and all the intellectual and industrial property rights relating thereto are copyrighted by POZZOLI GROUP srl. And forbidden their reproduction, copying, imitation, publication, dissemination, distribution, processing and use, even partial, advertising, products, packaging, artworks or advertising, websites, marketing activities and sales and all other use without the prior written permission of POZZOLI GROUP srl.

**OZZIO**<sup>®</sup> ITALIA

POZZOLI GROUP srl

Via Brughetti 17  
20813 Bovisio Masciago (MB)  
Italy

t. +39 0362 59701  
ozzio@ozzio.com  
www.ozzio.com