

PANZERI

CATALOGO TECNICO 2023
TECHNICAL CATALOGUE 2023

La scelta della carta su cui scrivere, sembra apparentemente un aspetto secondario nel processo di narrazione culturale che Panzeri vuole far giungere ai suoi clienti, ai creativi, agli esponenti della comunicazione multimediale.

Ma non è così.

Scegliamo quello che più ci rappresenta, e ogni aspetto del progetto ha una sua logica che si interfaccia con tutti gli altri, senza escluderne alcuno, ecco perché il foglio diventa uno dei materiali che servono per fare capire quello che vogliamo essere, e che tipo di futuro eco-sostenibile auspichiamo.

Non è dunque, un solo pezzo di carta, ma il contenitore di tutte le nostre storie, di tutti i desideri dell'azienda, dell'antico percorso di quanti hanno voluto condividere con noi queste scelte etiche ed estetiche: uno spazio libero per comprendere le "nostre parole, i nostri prodotti, l'ingegno creativo".

Buona lettura.

The choice of the paper might appear as a secondary aspect in the process of cultural narration that Panzeri wants to convey to its clients, to creatives, and to people in the multimedia communication.

It is not as such.

We choose what best represents us, and every aspect of the project has a logic that interrelates with the other, without excluding any of them. This is why the sheet becomes one of the materials used to let the public know what we want to be, and what kind of sustainable future we wish for.

It is therefore not, a simple piece of paper, rather it is a container of all our stories, of all the wishes of the company, of the ancient path of those who wanted to share with us these ethical and aesthetical choices: a free space to understand "our words"; our products, "our creative talent".

Enjoy the reading.

Milano, marzo 2021

Maurizio De Caro

Le carte utilizzate per la stampa di questo listino sono riciclate e certificate FSC®. La carta della copertina è un prodotto unico nel suo genere, che pur avendo una rilevante presenza di riciclo nell'impasto, grazie all'utilizzo di fibre di cotone mantiene una particolare morbidezza alla superficie. Carta composta da 25% di pura cellulosa certificata FSC®, 25% fibre di riciclo certificate FSC®, 40% di cellulosa CTMP e 10% fibre di cotone.

The papers used for printing this price list are recycled and certified FSC®. The cover page is a product unique in its genre. Despite a relevant presence of recycled material in the blend, it maintains an exceptional surface smoothness thanks to the adding of cotton fibers. Composite papers made of 25% of pure cellulose certified FSC®, 25% recycled fibers certified FSC®, 40% CTMP cellulose, and 10% cotton fibers.



PANZERI

CATALOGO TECNICO 2023
TECHNICAL CATALOGUE 2023

SELECTED PROJECTS	I
INDOOR	12
ACOUSTIC	162
CANOPIES AND OFFSET	171
OUTDOOR	176
PROFILES	192
SPOTLIGHT	234
RECESSED	261
LED PANEL	298
ELECTRIC OPTIONS	299
TECHNICAL INFORMATION	305

INTERNO / INDOOR



ALDECIMO
13



APP
14



ARENA
16



BELLA
20



BELLA VESTITA
24



BOW
26



NOVELTY



BROOKLYN LINE
34



BROOKLYN ROUND
37



BROOKLYN CANOPIES
39



BROOKLYN SPOT
36



CANDLE
42



CARL
44



CARL2
46



CARMEN
48



CLIO
110



CROSS
50



DISCO
52



ELY
54



EMMA
108



EMY
55



EVY
56



FIREFLY IN THE SKY
58



NOVELTY



GIANO
60



GILBERT
64



GINEVRA
66



GOLDEN RING
68



GONG
78



GONIO
80



HILOW
82



HILOW LINE
86



NOVELTY



JACKIE
88



JAY
92



KUBIK
94



LOLA
96



MURANÉ
98



NOVELTY



MURANÉ R
100



OLIVIA
106



ONE
112



OPUNTIA
114



PLANET RING
74



RORIS
118



NOVELTY



SILVER RING
72



SMOKE
122



THREE
124



TO-BE
125



TOY
128



TUBINO
130



TUBINO PLUS
133



TWO
134



VIISI
136



WILLY GLASS
138



YPSILON
140



ZERO
142



ZERO ROUND
SMART 144



ZERO ROUND
147



ZERO ROUND
VERTICAL 152



ZERO ELLIPSE
154



ZERO SQUARE
156



ZERO SHAPES
CANOPIES
158

ACUSTICA / ACOUSTIC



ARENA ACOUSTIC
163



NOVELTY



PHI
170



NOVELTY



ZERO ROUND ACOUSTIC
167



ROSONI E DECENTRAMENTI / OFFSET AND CANOPIES



171

ESTERNO / OUTDOOR



FIREFLY IN THE SKY
178



NOVELTY



FOUR
177



POTTER
182



RALPH
183



VENEXIA
188



TIPOLOGIE DI INSTALLAZIONE / MOUNTING TYPES

SOSPENSIONE / SUSPENSION PARETE / WALL SOFFITTO / CEILING TAVOLO / TABLE TERRA / FLOOR BINARIO / TRACK

DESIGN

ALDECIMO		•				
APP		•				
ARENA	•					
BELLA	•	•		•		
BOW		•	•			
BROOKLYN LINE	•					
BROOKLYN ROUND	•	•	•			
BROOKLYN SPOT		•	•			
CANDLE	•					•
CARL			•			
CARL2		•	•			
CARMEN		•	•			
CLIO	•					•
CROSS		•				
DISCO		•	•			
ELY	•					•
EMMA	•					•
EMY	•					•
EVY	•					•
FIREFLY in the sky				•		
GIANO	•	•				
GILBERT	•		•	•		•
GINEVRA	•	•	•			
GONIO		•				
GOLDEN RING	•					
GONG	•					
HILOW	•	•	•			
HILOW LINE		•			•	
JACKIE		•	•	•	•	•
JAY		•				
KUBIK	•	•	•	•		
LOLA		•	•			
MURANÈ	•	•	•			
MURANÈ R	•					
OLIVIA	•					•
ONE	•		•			•
OPUNTIA		•	•	•		
PLANET RING	•	•	•			
RORIS		•	•	•		
SILVER RING	•	•	•			
SMOKE	•					•
THREE		•	•			
TO-BE	•		•			
TOY		•				
TOY GYPSO		•				
TUBINO	•	•	•	•	•	
TUBINO PLUS				•		
TWO	•		•			•
VIISI	•				•	
WILLY GLASS	•					•
YPSILON		•				
ZERO		•	•			
ZERO ELLIPSE	•					
ZERO ROUND	•	•				
ZERO ROUND VERTICAL	•					
ZERO SQUARE	•					

ACUSTICA

ARENA ACOUSTIC	•					
PHI	•					
ZERO ROUND ACOUSTIC	•					

OUTDOOR

FIREFLY in the sky				•	•	
FOUR		•	•			
POTTER					•	
RALPH	•	•		•	•	
VENEXIA	•	•			•	

PROFILI / PROFILES



BROADWAY
230



BRONX
193



BROOKLYN
198



BROOKLYN OUT
198



BROOKLYN ROUND
196



BROOKLYN SPOT
203



BROOKLYN TRIM
198



CORNER
204



GIANO
207



HARLEM
212



KIPS
214



KIPS ROUND
213



MANHATTAN
216



NOLITA
220



NOLITA OUT
220



NOLITA TRIM
220



NOOK
231



TRIBECA
232



PROIETTORI / SPOTLIGHT



ASTORIA IN
240



ASTORIA OUT
242



ASTORIA LINE
238



ASTORIA SPOT
239



ASTORIA 5
235



JACKIE SPOT
245



NOVELTY

NOVELTY

NOVELTY

NOVELTY

NOVELTY



QUEENS
250



QUEENS 45
246



QUEENS 25
247



QUEENS 20
248



QUEENS 10
249



SOHO IN
257



SOHO OUT
259



SOHO LINE
240



SOHO S 15
255



SOHO 20
252



SOHO 10
253



SOHO 5
254



INCASSI / RECESSED



CLICK CLACK
262



EAST
264



EDDIE
271



NOVELTY



JAMES
274



NOVELTY



JARVIS
278



JESSIE
280



NOVELTY



JOE
296



MARK
282



MOAI
269



NICK
286



RALLY TRIM
288



NOVELTY



ROY
297



SID
292



NOVELTY



STEP BY STEP
267



TAYLOR
294



LED PANEL



JERSEY
298

ELECTRIC OPTIONS



299

TECHNICAL INFORMATION

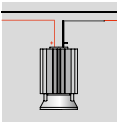

305

VADEMECUM LETTURA LISTINO / HOW TO READ PRICE LIST

Codice Qr / Qr-code **Nome della famiglia** / Family name **Foto** / Picture **Progettista e anno, eventuale registrazione** / Designer, year and possible registration **Descrizione** / Description

ZERO Studio Tecnico Panzeri 2012 Registered Design

Lampade da parete/soffitto in metallo bianco, cromo, bronzo, ottone satinato e foglia oro complete di LED e driver. Wall/ceiling lamps in white metal, chrome, bronze, matt brass and gold leaf complete with LED and driver.

Tipo di emissione luminosa / Light output **Dati e caratteristiche tecniche** / Data and technicals details **Potenza e flusso luminoso effettivi** / Effective power and luminous flux

CODICE CODE	FONTE LUMINOSA LIGHT SOURCES	kg	€
A03501.050.0401	Potenza assorbita apparecchio / Luminaire power consumption 11W Flusso luminoso apparecchio / Luminaire luminous flux 613lm 3000K Ra90 220-240V AC ON-OFF	1,37	277,00
A03517.050.0401			350,00
A03519.050.0401			326,00
A03521.050.0401			369,00
A03522.050.0401			338,00

Peso netto in kg / Net price in kilos

Disegno con dimensioni in cm e pollici / Drawing with dimensions in cm and inches

Possibilità di installazione / Fixing prospect

Prezzo di listino a seconda della finitura / Price list according to finishing

Documenti disponibili su www.panzeri.it/ / Photometric data available at www.panzeri.it/

CODICI COLORI DISPONIBILI / COLOUR CODES AVAILABLE **Disponibili a richiesta LED 2700K / On request 2700K LED available**

01 bianco / white 02 nero / black 10 ottone satinato / matt brass

Eventuali temperature di colore a richiesta / Possible light colour temperature on demand

SIGNIFICATO DELLA CODIFICA / CODE MEANING

Vedi tabella a fianco / See table on side

XG	231	01	360	00	99	Profilo da incasso Brooklyn round 100 360° No led No alimentazione / Recessed track Brooklyn round 100 white 360° No led No Electricity
A	016	37	025	01	01	Lampada da parete Toy acciaio inox lucido 25 cm Led 3000K Ra80 Alimentazione standard / Wall lamp Toy Polished stainless steel 25 cm 3000K Ra80 Standard power supply
C	077	03	000	04	13	Lampada da tavolo Jackie Rossa Led 3000K Ra90 lot step dim / Table lamp Jackie Red 3000K Ra90 lot step dim
L	081	21	180	01	02	Sospensione Golden Ring Foglia oro diametro 180 cm Led 3000K Ra80 DALI/PUSH DIM / Suspension Golden Ring gold leaf diameter 180 3000K Ra80 DALI/PUSH DIM

Elettrificazione
Electricity







Qualità della luce
Light quality

Dimensione caratteristica
Typical dimension

Numero di famiglia
Family number

Tipologia di installazione
Type of mounting

LEGENDA / LEGEND

	Emissione luminosa diretta e indiretta Direct and indirect light emission		Apparecchio con possibilità di installazione a plafone Fixture suitable for ceiling
	Emissione luminosa solo indiretta Indirect light emission only		Apparecchio da parete Wall fixture
	Emissione luminosa solo diretta Direct light emission only		Apparecchio con possibilità di installazione a parete e plafone Fixture suitable for ceiling and wall fixing

SISTEMA DI CODIFICA / CODE SYSTEM

Tipologia di installazione	Legenda	Finiture diffusori	Legenda	K/Ra /°	Legenda	Elettificazione	Legenda	
Type of mounting	Legend	Colour finish diffuser	Legend	K/Ra /°	Legend	Electricity	Legend	
A	parete / wall	00	nessuna / unfinished	00		00	standard	
B	attacco a binario / electrical adapter	01	bianco / white	01	3000K/80	01	alimentazione standard standard power supply	
C	tavolo / table	02	nero / black	02	2700K/80			
CA	parete-mensola / wall bracket	03	rosso / red	03	4000K/80	02	alimentazione DALI / PUSH DIM DALI / PUSH DIM power supply	
CM	tavolo morsetto / table clamp	04	nero gommato / rubber black	04	3000K/90			
CP	tavolo perno / table bolt down	05	champagne / champagne	05	2700K/90	03	alimentazione 1-10V / Push DIM 1-10V / PUSH DIM power supply	
EA	esterno parete / exterior wall	06	nero satinato / mat black	06	4000K/90			
EC	esterno tavolo / exterior table	07	avorio / ivory	11	2700K/80/NS	04	taglio di fase / phase cut	
EL	esterno sospensione exterior suspension	10	bianco lucido / glossy white	12	2700K/80/S	05	RGB	
		12	grigio metallizzato- paralume bianco metallized grey-white shade	13	2700K/80/FL	06	LED tensione di rete / 220V LED	
EP	esterno soffitto / exterior ceiling	13	grigio metallizzato- paralume plissé / metallized grey-plissé shade	14	2700K/80/WFL	07	emergenza / emergency	
ET	esterno terra / exterior floor			15	2700K/90/NS	08	mono standard	
L	sospensione / suspension	14	marrone metallizzato- paralume bianco/metallized brown-white shade	16	2700K/90/S	09	Step DIM	
M	sospensione senza rosone suspension without canopy	15	marrone metallizzato- paralume plissé/metallized brown-plissé shade	17	2700K/90/FL	10	24V	
		16	corten / corten	18	2700K/90/WFL	11	12V	
P	soffitto / ceiling	17	bronzo / bronze	19	3000K/80/NS	12	alimentazione a due livelli bilevel driver	
PE	esterno terra picchetto exterior floor peg	18	rame satinato / mat copper	20	3000K/80/S			
		19	ottone satinato / mat brass	21	3000K/80/FL	13	IoT-Step DIM	
T	terra / floor	20	ottone lucido / polished brass	22	3000K/80/WFL	14	batteria / battery	
X	incasso / recessed downlight	21	foglia oro / gold leaf	23	3000K/90/NS	15	corrente costante / constant current	
		22	cromo / chrome	24	3000K/90/S			
XG	sistema da incasso recessed linear system	23	foglia argento / silver leaf	25	3000K/90/FL	17	bianco dinamico/tunable white	
		24	foglia rame / copper leaf	26	3000K/90/WFL			
XGQ	invisibile senza cornice quadrato recessed trimless squared	25	rame lucido / polished copper	27	4000K/90/NS	18	24V DALI/Push DIM + corrente costante standard DALI/Push DIM 24V + standard constant current	
		27	verde oliva materico / textured olive green	28	4000K/90/S			
XGR	invisibile senza cornice tondo recessed trimless round	28	bianco soft materico / textured soft white	29	4000K/90/FL	19	48V DALI	
		29	terracotta naturale materico / textured natural terracotta	30	4000K/90/WFL			
XM	accessorio / accessory	30	titanio / titanium	31	3000K, CRI>85	21	DIM-to-warm + bianco dinamico DIM-to-warm + tunable white	
XP	sistema sosp-soffitto- parete suspension-ceiling-wall system	31	grigio metallizzato-diffusore nero / metallized grey-black diffuser	32	2700K, CRI>85			
		32	nicel / nickel	33	4000K, CRI>85	22	dimmer su cavo / dimmer on cable	
Y	accessorio / accessory	33	grigio metallizzato-diffusore bianco / metallized grey-white diffuser	34	2700K, CRI>85, NS	23	wireless ZigBee	
		34	grigio micaceo / micaceous grey	35	2700K, CRI>85, S			
		35	alluminio sabbato / sanded aluminum	36	2700K, CRI>85, FL	24	24V + corrente costante 24V + constant current	
		36	anodizzato naturale / natural anodized	37	2700K, CRI>85, WFL			
		37	acciaio inox lucido / polished stainless steel	38	3000K, CRI>85, NS	99	no elettrificazione / no electricity	
		38	grigio metallizzato/diffusori bianco-nero metallized grey/white-black diffusers	39	3000K, CRI>85, S			
		39	acciaio inox satinato / mat stainless steel	40	3000K, CRI>85, FL			
		40	titanio-diffusore fumé / titanium-smoky grey diffuser	42	4000K, CRI>85, NS			
		41	titanio-diffusore bianco / titanium-white diffuser	43	4000K, CRI>85, S			
		42	gesso / plaster	44	4000K, CRI>85, FL			
		44	marrone metallizzato / metallized brown	45	4000K, CRI>85, WFL			
		45	legno-ottone satinato / wood-mat brass	90	2700-6500K/90			
		46	bianco-policarbonato opale / white-opal polycarbonate	91	2200-4000K/90			
		47	bianco-policarbonato prismatico / white-micropismatic polycarbonate					
		48	nero-policarbonato opale / black-opal polycarbonate					
		49	nero-policarbonato prismatico / black-micropismatic polycarbonate					
		50	metal-silver / metal-silver					
		51	nero-diffusore bianco / black-white diffuser					
		52	nero-diffusore cristallo / black-crystal diffuser					
		53	nero-diffusore acciaio / black-steel diffuser					
		54	nero-diffusore ambra / black-amber diffuser					
		55	nero-diffusore bronzo / black-bronze diffuser					
		56	nero-diffusore tabacco / black-tobacco diffuser					
		57	nero-diffusore verde / black-green diffuser					
		61	rame lucido-diffusore bianco / polished copper-white diffuser					
		62	rame lucido-diffusore cristallo / polished copper-crystal diffuser					
		63	rame lucido-diffusore acciaio / polished copper-steel diffuser					
		64	rame lucido-diffusore ambra / polished copper-amber diffuser					
		65	rame lucido-diffusore bronzo / polished copper-bronze diffuser					
		66	rame lucido-diffusore tabacco / polished copper-tobacco diffuser					
		67	rame lucido-diffusore verde / polished copper-green diffuser					
		71	ottone satinato-diffusore bianco / mat brass-white diffuser					
		72	ottone satinato-diffusore cristallo / mat brass-crystal diffuser					
		73	ottone satinato-diffusore acciaio / mat brass-steel diffuser					
		74	ottone satinato-diffusore ambra / mat brass-amber diffuser					
		75	ottone satinato-diffusore bronzo / mat brass-bronze diffuser					
		76	ottone satinato-diffusore tabacco / mat brass-tobacco diffuser					
		77	ottone satinato-diffusore verde / mat brass-green diffuser					
		80	nero satinato-oro / mat black-gold					
		81	bianco-oro / white-gold					
		83	legno / wood					
						Descrizione fascio Light beam description	Legenda Legend	Gradi Degrees
						Fascio strettissimo Narrow	NS	< 12°
						Fascio stretto Spot	S	13°->21°
						Fascio medio Flood	FL	22°->40°
						Fascio largo Wide flood	WFL	41°->60°
						Fascio diffuso Diffused	Nessuna sigla No code	> 60°

INDEX

Page	Code	Collection	Page	Code	Collection
122	015	Smoke	242	9005	Astoria Out
128	016	Toy	245	B077	Jackie Spot
80	019	Gonio	239	B430	Astoria Spot
136	020 - 021	Viisi	238	B431	Astoria Line
13	022	AlDecimo	235	B432	Astoria 5
125	025 - 026 - 027	To-be	240	B470	Soho Line
82	028 - 029	Hilow	255	B700	Soho S 15
154	031	Zero Ellipse	254	B752	Soho 5
156	032	Zero Square	253	B753	Soho 10
147	033	Zero Round	252	B754	Soho 20
152	034	Zero Round Vertical	248	B760	Queens 20
142	035	Zero	246	B770	Queens 45
112	037	One	282	X017	Mark
134	038	Two	294	X168	Taylor
124	039	Three	298	X335	Jersey
182	042	Potter	296	XA2115	Joe
177	044	Four	296	XA2116	Joe
167	045	Zero Round Acoustic	203	XG203	Brooklyn Spot
163	046	Arena Acoustic	196	XG231 - XG232	Brooklyn Round
183	047	Ralph	220	XG238	Nolita
188	048	Venexia	220	XG239	Nolita Trim
50	049	Cross	193	XG247	Bronx
20	052 - 053	Bella	232	XG249	Tribeca
167	055	Zero Round Acoustic	212	XG251	Harlem
163	056	Arena Acoustic	214	XG270	Kips
170	058	Phi	213	XG271-XG272-XG273	Kips Round
48	064	Carmen	198	XG2033	Brooklyn
64	065	Gilbert	198	XG2034	Brooklyn Trim
52	066	Disco	216	XG2044	Manhattan
114	068	Opuntia	204	XG2045	Corner
94	070	Kubik	264	XGQ0998	East
140	072	Ypsilon	265	XGQ0998GL	East
130	073	Tubino	265	XGQ1004	East
133	073	Tubino Plus	265	XGQ1004-GL	East
16	074	Arena	268	XGQ1025	Step by Step
138	076	Willy	268	XGQ1026	Step by Step
88	077	Jackie	269	XGQ1210	Moai
58	078	Firefly in the sky	270	XGQ1211	Moai
68	081	Golden Ring	264	XGR0997	East
72	082	Silver Ring	266	XGR1021	East
74	083	Planet Ring	267	XGR1023	Step by Step
108	091	Emma	267	XGR1024	Step by Step
66	092	Ginevra	266	XGR1027	East
78	093	Gong	262	XGR1212	Click Clack
110	094	Clio	250	XM75 - XM76	Queens
42	095	Candle	259	XM445	Soho Out
106	097	Olivia	257	XM446	Soho In
14	098	App	249	XM748	Queens 10
54	100	Ely	247	XM751	Queens 25
55	101	Emy	220	XP238	Nolita Out
56	102	Evy	207	XP246	Giano
147	103	Zero Round	230	XP248	Broadway
86	108-109-110	Hilow Line	231	XP250	Nook
118	112	Roris	198	XP2033	Brooklyn Out
98	115	Murané	278	XR130 - 131	Jarvis
100	116	Murané R	286	XR225	Nick
96	120	Lola	292	XR170	Sid
44	122-123	Carl	271	XR172	Eddie
46	125	Carl2	280	XR174	Jessie
92	135 - 136	Jay	274	XR177	James
26	138	Bow	288	XR178	Rally Trim
36	203	Brooklyn Spot	286	XR254	Nick
37	231 - 232	Brooklyn Round	297	XR255	Roy
34	233	Brooklyn Line	286	XR262	Nick
60	246	Giano	171		Rosoni e decentr.
240	9005	Astoria In			

Resort Reina del Mar

Hotel

Obzor, Bulgaria, 2020

Architect

Archview Gradinarska

Products

Brooklyn Round, Zero Round

Il progetto ha voluto creare un ambiente caldo e accogliente per gli ospiti del resort e si è focalizzato sugli aspetti funzionali e decorativi, capaci di mettere in luce l'eleganza degli spazi e allo stesso tempo di rispecchiare la dinamicità dell'intero complesso.

Una composizione di linee curve a semi-incasso che si incrociano tra loro, realizzata con **Brooklyn Round** custom, si alterna ad una di **Zero Round** di diametri differenti sospesi ad altezze diverse.

Con i loro profili LED sinuosi e raffinati, Brooklyn Round e Zero Round, rendono l'ambiente ideale per un momento di relax, per una piacevole conversazione o per un drink in uno spazio esclusivo.



The project aimed to create a warm and welcoming environment for the resort's guests and focused on functional and decorative aspects, capable of highlighting the elegance of the spaces and at the same time reflecting the dynamism of the entire complex.

A composition of curved semi-recessed lines intersecting each other, created with custom **Brooklyn Round**, alternates with one of **Zero Round** of different diameters suspended at various heights.

With their sinuous and refined LED profiles, Brooklyn Round and Zero Round make an ideal setting for a moment of relaxation, a pleasant conversation or a drink in an exclusive place.



Hotel a Taormina

Hotel

Taormina, Italy, 2022

Project

Landscape architect: Marco Bay
Interior architect: Valentina Pisani

Products

Firefly, Ralph



L'illuminazione di alcuni spazi dei ristoranti è stata affidata alle lampade Panzeri, che si integrano perfettamente anche con gli ambienti circostanti.

Firefly, con le sue geometrie semplici e discrete, crea interessanti punti di luce sulle tavole del ristorante Principe Cerami, dove le grandi vetrate permettono di affacciare lo sguardo sul suggestivo panorama.

Ralph, invece, lampada a sospensione studiata per gli esterni, grazie al suo paralume in rattan sintetico intrecciato, è la scelta perfetta per il design dalle suggestioni naturali della veranda del ristorante Anciovi.

The lighting of some of the restaurant spaces has been entrusted to Panzeri lamps, which also blend in perfectly with the surroundings.

Firefly, with its simple and discreet geometries, creates interesting points of light on the tables of the Principe Cerami restaurant, where the large glass windows allow a view of the evocative panorama.

Ralph, on the other hand, the pendant lamp designed for outdoors, thanks to its woven synthetic rattan lampshade, is the perfect choice for the naturally evocative design of the veranda of the Anciovi restaurant.

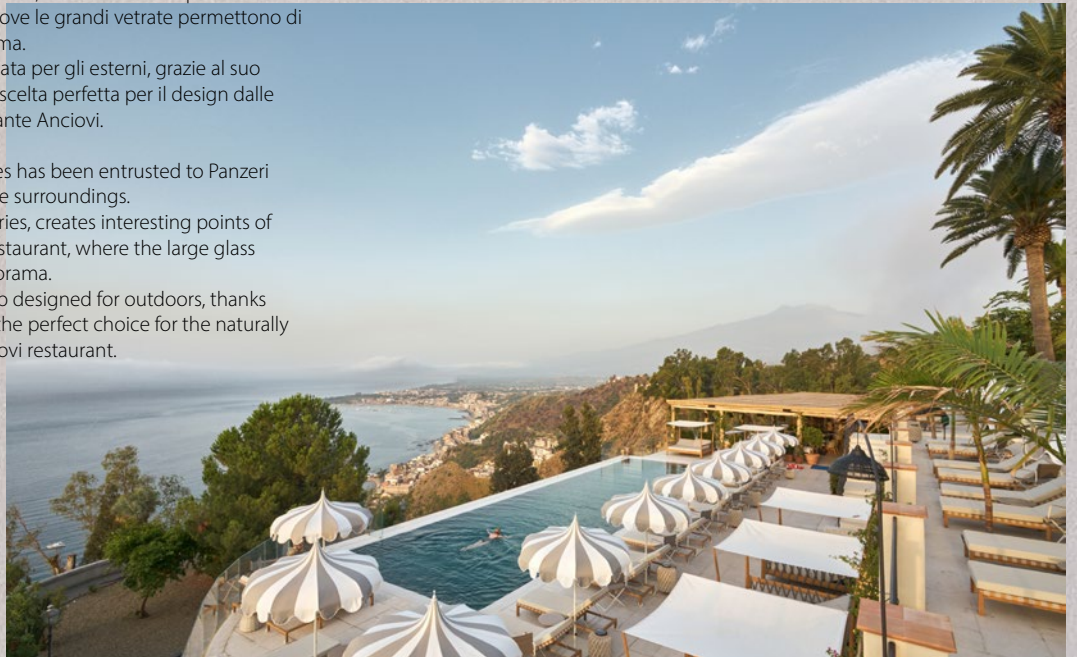

Casa privata, Bruxelles

Residential

Bruxelles, Belgium, 2022

Project

Isabel Gómez Studio

Products

Zero Square, Bella, Jackie

Questo progetto residenziale conferma che la sinergia tra arredamento e illuminazione è in grado di creare un ambiente confortevole e piacevole. La luce gioca un ruolo fondamentale: gli apparecchi Panzeri dialogano con le ampie vetrate creando zone funzionali.

Zero Square, lampada a sospensione in alluminio curvato, si presenta come una soluzione elegante e d'effetto per accogliere gli ospiti nella sala da pranzo.

La forma lineare e pulita di **Bella**, posizionata sopra il bancone della cucina, rende accattivanti anche gli ambienti più minimali e semplici. Per esaltare anche l'aspetto più funzionale della luce, design e tecnologia si uniscono in **Jackie**, una lampada da tavolo che offre una regolazione della luce personalizzata e controllata in ogni situazione.

This residential project confirms that the synergy between furniture and lighting is able to create a comfortable and pleasant environment. Light plays a key role: Panzeri luminaires dialogue with the large windows to create functional zones.

Zero Square, a pendant lamp in curved aluminium, is an elegant and impressive solution for welcoming guests in the dining room. The clean, linear form of **Bella**, positioned above the kitchen counter, makes even the most minimalist and simple of rooms eye-catching. To enhance even the most functional aspect of light, design and technology come together in **Jackie**, a table lamp that offers customised and controlled light in every situation.





Villa Primavera

Residential

Agios Tychonas, Cyprus, 2022

Architect

Arch. Elena Sharapova, Arch. Sotiris Paschalis

Interior Design

Arch. Elena Sharapova

Furniture

Allure Luxury Group srl

Products

Zero Round Vertical, Zero Round, Zero Square



Villa Primavera rappresenta un esempio di integrazione tra design, architettura e ambiente esterno, dove l'illuminazione gioca un ruolo fondamentale.

Zero Round Vertical, con il suo design elegante, illumina scenograficamente la scalinata interna conferendo uno stile ricercato agli ambienti.

Zero Round, combinata con **Zero Square**, è stata scelta per illuminare il salone principale, dialogando armonicamente con le grandi vetrate che circondano l'arredo.

Villa Primavera is an example of the integration of design, architecture and the outdoor environment, where lighting plays a key role.

Zero Round Vertical, with its elegant design, dramatically illuminates the internal staircase giving a refined style to the rooms.

Zero Round, combined with **Zero Square**, was chosen to illuminate the main hall, dialoguing harmoniously with the large windows surrounding the furniture.



Beauty on Braid

Residential

New Zealand, 2022

Architect

Landmarks Homes Hamilton

Project

Coombes & Gabbie Lighting Design Limited

Products

Zero Round, Ginevra, Golden Ring, Bella



Le lampade Panzeri sono state scelte per conferire all'ambiente un tono di classe in armonia con l'architettura delle stanze.

Zero Round offre un forte impatto scenografico nella sala caratterizzata da grandi e luminose vetrate. Il salone dedicato alla convivialità e all'intrattenimento è valorizzato da **Golden Ring**, che grazie ai suoi grandi anelli a sospensione, crea un interessante gioco di forme senza appesantire il panorama visivo circostante.

Il design pulito e lineare di **Bella** si presta a diverse originali composizioni, in cui elementi a luce diretta e indiretta, si adattano all'illuminazione della sala da pranzo. Non solo funzionalità, ma anche un'estetica ben studiata, sono il fulcro dell'arredo del progetto residenziale. **Ginevra** accoglie l'ospite nel salone open space aiutando a identificare le diverse funzioni delle varie aree.

Panzeri lamps were chosen to give the ambience a classy tone in harmony with the architecture of the rooms.

Zero Round offers a strong scenic impact in the hall characterised by large, bright windows. The hall dedicated to conviviality and entertainment is enhanced by **Golden Ring**, which, thanks to its large suspended rings, creates an interesting play of shapes without weighing down the surrounding visual landscape.

Bella's clean and linear design lends itself to various original compositions, in which direct and indirect light elements are adapted to the lighting of the dining room. Not only functionality, but also wellthought- out aesthetics are at the heart of the furnishing of the residential project. **Ginevra** welcomes the guest into the open-plan living room, helping to identify the different functions of the various areas.



Bodrum Z House

Residential

Bodrum, Turkey, 2022

Architect

Habif Architects & Setenay Erkul

Photographs

Sinan Çırak

Products

Ypsilon, Bella, Tubino





L'illuminazione di questa casa è stata pensata appositamente per metterne in risalto il design. **Ypsilon** regala un piacevole percorso di luce lungo il corridoio che collega le stanze, creando un effetto di luce indiretta pulito e discreto.

Bella e Tubino, nella loro versione da parete, offrono un fascio luminoso direzionale vicino alla testiera del letto, in modo da unire funzionalità ed eleganza alle camere per il riposo.

The lighting in this house has been specially created to emphasise its design. **Ypsilon** provides a pleasant light path along the corridor connecting the rooms, creating a clean and discreet indirect lighting effect.

Bella and Tubino, in their wallmounted version, offer a directional light beam close to the headboard of the bed, combining functionality and elegance in rooms dedicated to relaxation and rest.

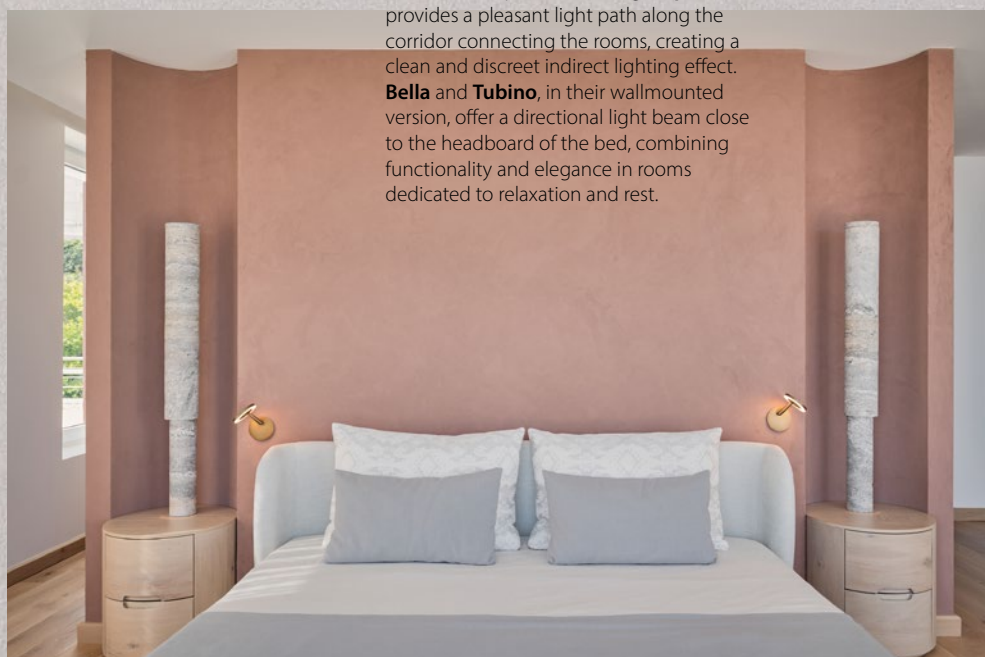

Country House with SPA

Residential

Moscow, Russia, 2021

Project

AIYA bureau

Products

Emma, Olivia, Clio, Manhattan



In una moderna villa con spa, in cui la luce naturale e quella artificiale si combinano per creare spazi rilassanti e permeabili alla natura, gli apparecchi di illuminazione Panzeri sono scelti per valorizzare le finiture e la dimensione estetico-funzionale degli ambienti. Un'elegante composizione multipla delle sospensioni in vetro **Olivia, Emma e Clio** si presta a decorare e esaltare la sala da pranzo. L'area riservata alla spa, caratterizzata da materiali dai toni naturali e avvolgenti, viene illuminata dal profilo **Manhattan**, con una luce perimetrale soffusa che allarga lo spazio e ne definisce le geometrie.

In a modern villa with spa, in which natural and artificial light combine to create relaxing spaces permeable to nature, Panzeri lighting fixtures are chosen to enhance the finishes and the aesthetic-functional dimension of the rooms. An elegant multiple composition of **Olivia, Emma and Clio** glass pendants decorates and enhances the dining room. The area reserved for the spa, characterised by materials in natural and enveloping tones, is lighted by the **Manhattan** profile, with a soft perimeter light that enlarges the space and defines its geometries.



Casa Baglioni

Hotel

Milan, Italy, 2022

Project

Spagnulo&Partners

Products

Zero Round, Lola custom fixture





L'esperienza di Panzeri nell'offrire soluzioni di illuminazione eleganti e custom made è stata sfruttata appieno per arredare gli spazi dell'hotel Casa Baglioni, nel centro di Milano. Una fitta composizione sospesa di **Zero Round**, posizionata all'ingresso, cattura l'attenzione dei visitatori conferendo all'ambiente circostante dinamicità e solennità. I faretto a semi-incasso **Lola** enfatizzano le numerose opere d'arte presenti sulle pareti. Le stanze e gli spazi comuni sono nobilitati da numerosi apparecchi realizzati appositamente in modo che la luce si integri nell'architettura.

Panzeri's experience in offering elegant and custommade lighting solutions was fully exploited to furnish the spaces of Casa Baglioni hotel, in the centre of Milan. A dense suspended composition of **Zero Round** positioned at the entrance captures the attention of visitors, lending the surroundings dynamism and solemnity. The semi-recessed **Lola** spotlights highlights the numerous works of art on the walls. Rooms and common areas are ennobled by various custom-made fixtures in order to ensure that the light could be integrated into the architecture.



INTERNO / INDOOR

13	ALDECIMO	88	JACKIE
14	APP	92	JAY
16	ARENA	94	KUBIK
20	BELLA	96	LOLA
26	BOW	98	MURANÈ
34	BROOKLYN LINE	100	MURANÈ R
37	BROOKLYN ROUND	106	OLIVIA
39	BROOKLYN ROUND CANOPIES	112	ONE
36	BROOKLYN SPOT	114	OPUNTIA
42	CANDLE	74	PLANET RING
44	CARL	118	RORIS
46	CARL2	72	SILVER RING
48	CARMEN	122	SMOKE
110	CLIO	124	THREE
50	CROSS	125	TO-BE
52	DISCO	128	TOY
54	ELY	130	TUBINO
108	EMMA	133	TUBINO PLUS
55	EMY	134	TWO
56	EVY	136	VIISI
58	FIREFLY in the sky	138	WILLY GLASS
60	GIANO	140	YPSILON
64	GILBERT	142	ZERO
66	GINEVRA	144	ZERO ROUND SMART
68	GOLDEN RING	154	ZERO ELLIPSE
78	GONG	147	ZERO ROUND
80	GONIO	152	ZERO ROUND VERTICAL
82	HILOW	156	ZERO SQUARE
86	HILOW LINE	158	ZERO SHAPES CANOPIES



ALDECIMO

Carmen Ferrara 2017

Registered Design



Lampada ad incasso da parete a scomparsa in metallo con meccanismo di apertura e chiusura a pressione. Sorgente luminosa composta da modulo LED a luce indiretta e driver bi-level integrato nell'apparecchio per diminuire il consumo e il flusso luminoso in modalità di chiusura, per ottenere un perimetro luminoso. Finitura in vernice poliaccrilica bianca. Ideale per camere da letto, living e per creare composizioni d'effetto su grandi pareti.

Wall-mount metal recessed trimless lamp with opening and closing click mechanism. Light source made of LED module with indirect light and integrated bi-level driver to reduce luminous flux and power consumption, creating a luminous perimetral frame, when closed. Finish in white polyacrylic paint. Ideal for bedrooms, living areas and to create composition on wide walls.

CODICE CODE		FONTI LUMINOSE LIGHT SOURCES		kg
X02201.030.0412		Potenza assorbita apparecchio / Luminaire power consumption 21W Flusso luminoso apparecchio / Luminaire luminous flux 873lm 3000K Ra>90 220-240V AC bilevel dimming		1,28



Fotometrie disponibili www.panzeri.it / Photometric data available at www.panzeri.it

CODICI COLORI DISPONIBILI / COLOUR CODES AVAILABLE

- 01 bianco
- white





Lampada da parete in profilato di alluminio estruso. Sorgente luminosa composta da 1 modulo LED o 2 moduli LED a tensione di rete (220V). Modulo LED equipaggiato con speciale protezione da sovratensioni e coperchio di protezione trasparente. Dimmerazione possibile attraverso apposito variatore di luce (non incluso). Finitura con vernice poliaccrilica bianca, ottone satinato o spazzolato e verniciato color titanio. Fissaggio con grani laterali a scomparsa. Ideale per corridoi o uso residenziale.

Wall lamp in extruded aluminium. Lighting source made of 1 LED module or 2 LED modules to mains voltage (220V). LED module equipped with special protection from power surges and transparent cover. Possible dimming with specific dimmer (not included) – available as accessory. White or mat brass polyacrylic paint or brushed and painted in titanium colour. Fixing with hidden lateral grub screw. Ideal for corridors or residential use.

CODICE CODE	FONTI LUMINOSE LIGHT SOURCES	kg
-------------	------------------------------	----

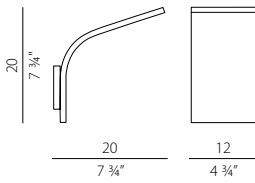

A09801.001.0406
A09819.001.0406
A09830.001.0406

Potenza assorbita apparecchio / Luminaire power consumption 18W
Flusso luminoso apparecchio / Luminaire luminous flux 1431lm
3000K Ra>90 220-240V AC ON-OFF
 IP20

1,00

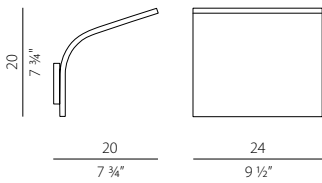

A09801.002.0406
A09819.002.0406
A09830.002.0406

Potenza assorbita apparecchio / Luminaire power consumption 36W
Flusso luminoso apparecchio / Luminaire luminous flux 2862lm
3000K Ra>90 220-240V AC ON-OFF
 IP20

2,03

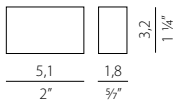
**XM14/230**

Dispositivo dimmerabile per moduli LED a 230V, 5÷100W.
Dimmable device for 230V LED modules, 5÷100W.

Fotometrie disponibili www.panzeri.it / Photometric data available at www.panzeri.it

CODICI COLORI DISPONIBILI / COLOUR CODES AVAILABLE

Disponibili a richiesta LED 2700K / On request 2700K LED available

01 bianco
white

19 ottone satinato
mat brass

30 titanio
titanium

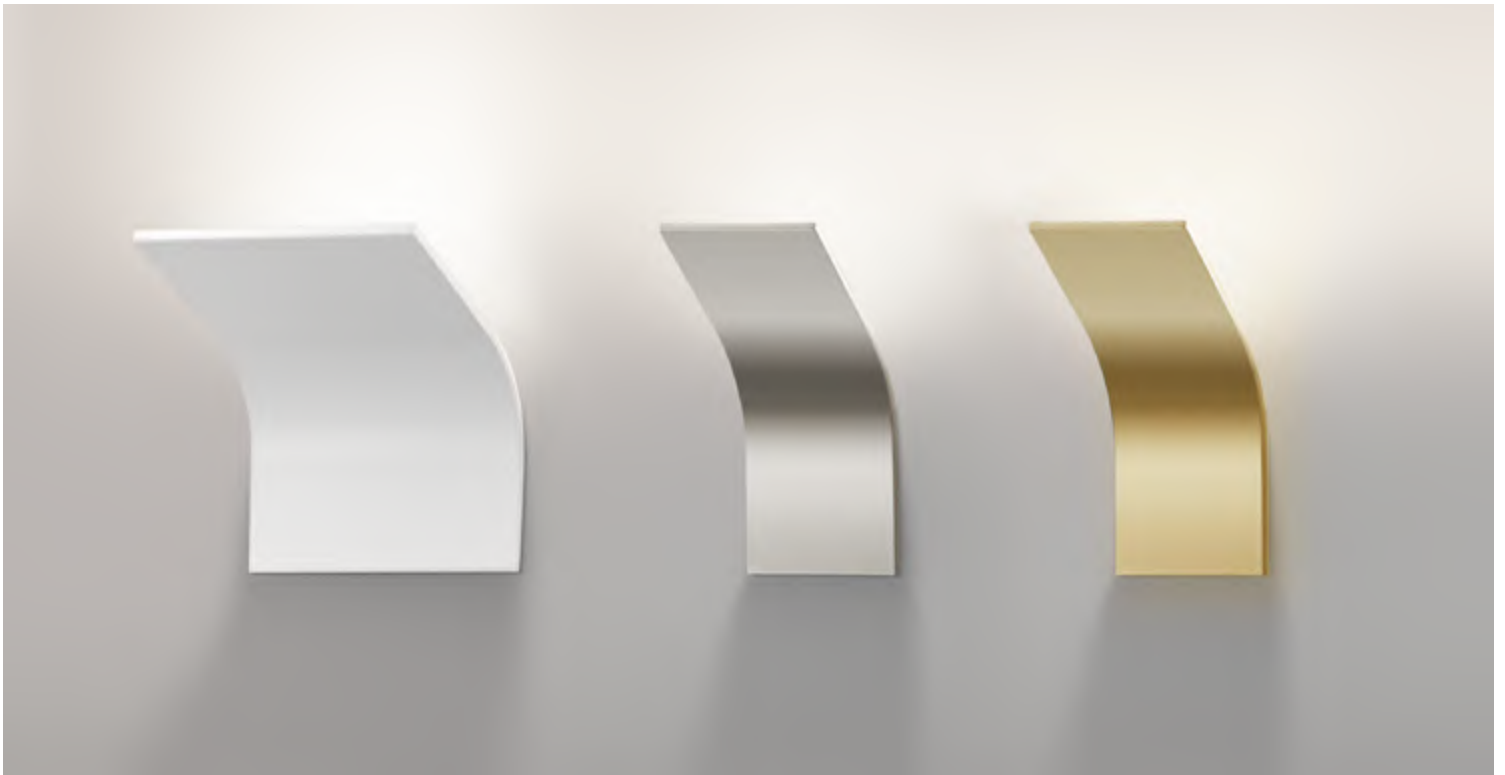





Lampada a sospensione in alluminio estruso curvato con schermo in policarbonato opale e spot orientabili. Tecnologia DALI/Push DIM di serie per la dimmerazione della linea di luce ad emissione interna e spot non dimmerabili su tutte le versioni. Finitura in vernice poliaccrilica color bianco, nero, titanio, bronzo e ottone satinato. Possibili colori custom su richiesta. Ideale per hall, zone living, retail e grandi spazi.

Suspension lamp in extruded curved aluminium with opal polycarbonate screen and adjustable spots. Emission on the internal side provided by LED modules with DALI/Push DIM technology dimming for the linear light and non-dimmable spots on all versions. White, black, titanium, bronze and mat brass finishes are available. Custom colors are available on request. Ideal for halls, living areas, retail and large spaces.

CODICE CODE	FONTI LUMINOSE LIGHT SOURCES	kg
-------------	------------------------------	----

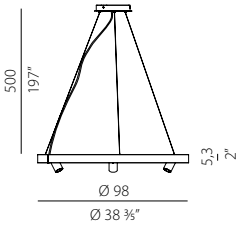

- L07401.100.0518**
- L07402.100.0518**
- L07417.100.0518**
- L07419.100.0518**
- L07430.100.0518**

Potenza assorbita apparecchio / Luminaire power consumption 92W 4,82
 Flusso luminoso apparecchio / Luminaire luminous flux 4191lm + 3 x 847lm
 2700K Ra>90 30° 220-240V AC dimmable (DALI/Push DIM) and ON-OFF
IP20
 Fornito con nr. 3 **M79D** per eventuale decentramento del rosone
 Supplied with nr. 3 **M79D** for possible reposition of canopy

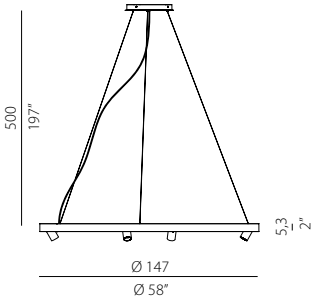

- L07401.150.0518**
- L07402.150.0518**
- L07417.150.0518**
- L07419.150.0518**
- L07430.150.0518**

Potenza assorbita apparecchio / Luminaire power consumption 129W 7,52
 Flusso luminoso apparecchio / Luminaire luminous flux 6287lm + 4 x 847lm
 2700K Ra>90 30° 220-240V AC dimmable (DALI/Push DIM) and ON-OFF
IP20
 Fornito con nr. 3 **M79D** per eventuale decentramento del rosone
 Supplied with nr. 3 **M79D** for possible reposition of canopy

ARENA

Enzo Panzeri 2020

Registered Design

	CODICE CODE	FONTI LUMINOSE LIGHT SOURCES	kg
	L07401.200.0518	Potenza assorbita apparecchio / Luminaire power consumption 154W	8,80
	L07402.200.0518	Flusso luminoso apparecchio / Luminaire luminous flux 8383lm + 5 x 847lm	
	L07417.200.0518	2700K Ra>90 30° 220-240V AC dimmable (DALI/Push DIM) and ON-OFF	
	L07419.200.0518	IP20	
	L07430.200.0518	Fornito con nr. 4 M79D per eventuale decentramento del rosone Supplied with nr. 4 M79D for possible reposition of canopy	

Fotometrie disponibili www.panzeri.it / Photometric data available at www.panzeri.it

CODICI COLORI DISPONIBILI / COLOUR CODES AVAILABLE

Disponibili a richiesta LED 3000K / On request 3000K LED available

01 bianco
white

02 nero
black

17 bronzo
bronze

19 ottone satinato
mat brass

30 titanio
titanium









Lampada da sospensione, tavolo e parete (disponibile anche a incasso) con testa in pressofusione di alluminio. Diffusore in materiale acrilico con perimetro luminoso. Braccio conico decentrato, testa orientabile e comando Step DIM a 5 regolazioni di intensità luminosa caratterizzano le versioni da tavolo e parete, quest'ultima con snodo anche alla base, per una maggiore flessibilità nel posizionamento. La versione a sospensione, testa fissa e con tige centrale è disponibile in versione a emissione diretta e indiretta. Disponibile paralume in tessuto color avorio "Bella vestita" disegnato da Matteo Thun, da ordinare separatamente. Bianco, nero, titanio, bronzo e ottone satinato le finiture disponibili.

Suspension, table and wall lamp (also available recessed) with die-cast aluminium head. Diffuser in acrylic material with luminous perimeter. Decentralized conical arm, adjustable head and technology Step DIM with 5 intensity of light settings characterize the table and wall versions, the latter also with a joint at the base, for a higher positioning flexibility. The suspension version has a fixed head with central tige, is available in direct and indirect light versions. Ivory fabric lampshade "Bella vestita" designed by mateo Thun is available, to order separately. White, black, titanium, bronze and mat brass finishes are available.

	CODICE CODE	FONTI LUMINOSE LIGHT SOURCES	kg
	L05201.011.0501	Potenza assorbita apparecchio / Luminaire power consumption 6,5W	0,55
	L05202.011.0501	Flusso luminoso apparecchio / Luminaire luminous flux 388lm	
	L05217.011.0501	2700K Ra>90 220-240V AC ON-OFF	
	L05219.011.0501	IP40	
	L05230.011.0501		
	L05301.011.0501	Potenza assorbita apparecchio / Luminaire power consumption 6,5W	0,55
	L05302.011.0501	Flusso luminoso apparecchio / Luminaire luminous flux 388lm	
	L05317.011.0501	2700K Ra>90 220-240V AC ON-OFF	
	L05319.011.0501	IP40	
	L05330.011.0501		
	M05201.011.0510	Potenza assorbita apparecchio / Luminaire power consumption 4,5W	0,22
	M05202.011.0510	Flusso luminoso apparecchio / Luminaire luminous flux 388lm	
	M05217.011.0510	2700K Ra>90 24V DC	
	M05219.011.0510	IP40	
	M05230.011.0510	Fornito senza rosone e driver, per composizioni multiple Supplied without canopy and driver, for multiple configurations	
	M05301.011.0510	Potenza assorbita apparecchio / Luminaire power consumption 4,5W	0,22
	M05302.011.0510	Flusso luminoso apparecchio / Luminaire luminous flux 388lm	
	M05317.011.0510	2700K Ra>90 24V DC	
	M05319.011.0510	IP40	
	M05330.011.0510	Fornito senza rosone e driver, per composizioni multiple Supplied without canopy and driver, for multiple configurations	

BELLA

Enzo Panzeri 2019/2020

Registered Design

	CODICE CODE	FONTE LUMINOSE LIGHT SOURCES	kg
	C05201.011.0509	Potenza assorbita apparecchio / Luminaire power consumption 5W	0,88
	C05202.011.0509	Flusso luminoso apparecchio / Luminaire luminous flux 388lm	
	C05217.011.0509	2700K Ra>90 220-240V AC dimmable (Step DIM)	
	C05219.011.0509	IP20	
	C05230.011.0509	Interruttore incluso Switch included	

	A05201.011.0509	Potenza assorbita apparecchio / Luminaire power consumption 5W	0,56
	A05202.011.0509	Flusso luminoso apparecchio / Luminaire luminous flux 388lm	
	A05217.011.0509	2700K Ra>90 220-240V AC dimmable (Step DIM)	
	A05219.011.0509	IP20	
	A05230.011.0509	Interruttore incluso Switch included	

	X05201.011.0509	Potenza assorbita apparecchio / Luminaire power consumption 5W	0,93
	X05202.011.0509	Flusso luminoso apparecchio / Luminaire luminous flux 388lm	
	X05217.011.0509	2700K Ra>90 220-240V AC dimmable (Step DIM)	
	X05219.011.0509	IP20	
	X05230.011.0509	Interruttore incluso Switch included	



reddot winner 2020

Fotometrie disponibili www.panzeri.it / Photometric data available at www.panzeri.it

CODICI COLORI DISPONIBILI / COLOUR CODES AVAILABLE

01 bianco
white

02 nero
black

17 bronzo
bronze

19 ottone satinato
mat brass

30 titanio
titanium









BELLA VESTITA

Matteo Thun 2020



Paralume in tessuto plissé, accessorio per Bella a sospensione con emissione diretta.

Pleated fabric lampshade, accessory for suspended Bella with direct light.

		CODICE CODE		kg
6 2 3/8"		YPL05207.015	Paralume in tessuto plissé colore avorio, semplice installazione a scatto. Ivory pleated fabric lampshade, simple snap installation.	0,08
15 6"				

Fotometrie disponibili www.panzeri.it / Photometric data available at www.panzeri.it

CODICI COLORI DISPONIBILI / COLOUR CODES AVAILABLE

07 avorio
ivory







Bow è l'espressione della flessibilità, una sottile linea che si curva sulle pareti per creare nuove geometrie attraverso la forma e la luce. Il corpo in policarbonato estruso si presta per accogliere segmenti di luce che possono essere posizionati a piacimento lungo tutta la sua estensione, creando linee luminose continue oppure tratti alternati. Questa versatilità permette di poter giocare con l'architettura disegnando linee rette, curve, zone luminose e zone buie.

Bow può essere accorciato a piacimento e installato sia singolarmente che in configurazioni lineari composte da più moduli. Disponibile nelle finiture bianco, nero satinato e legno. Una serie di accessori completa la famiglia per permettere di personalizzare l'installazione e l'illuminazione.

Bow is the expression of flexibility, a thin line that curves around the walls to create new geometries through shape and light. The extruded polycarbonate body lends itself to accommodate segments of light that can be positioned at will along its entire extension, creating continuous light lines or alternating strokes. This versatility makes it possible to play with the architecture by drawing straight lines, curves, bright zones and dark zones. Bow could be cut and installed either singly or in linear configurations composed of several modules. Available in white, mat black and wood finishes. A series of accessories completes the family to allow customised installation and lighting.

NOVELTY	CODICE CODE	FONTI LUMINOSE LIGHT SOURCES	kg
	 <p>A13801.302.0010 A13806.302.0010 A13883.302.0010</p>	<p>Profilo elettrificato flessibile. Alimentazione 24V DC. Flexible electrified profile. Power supply 24V DC.</p> <p>IP20 ⚡</p> <p>Completo di n.2 box di fissaggio e kit di alimentazione. LED e driver non inclusi.</p> <p>Complete with 2 fixing boxes and power supply kit. LED and driver not included.</p>	
	 <p>A13801.303.0010 A13806.303.0010 A13883.303.0010</p>	<p>Profilo elettrificato flessibile. Alimentazione 24V DC. Flexible electrified profile. Power supply 24V DC.</p> <p>IP20 ⚡</p> <p>Completo di n.3 box di fissaggio e kit di alimentazione. LED e driver non inclusi.</p> <p>Complete with 3 fixing boxes and power supply kit. LED and driver not included.</p>	
	 <p>A13801.304.0010 A13806.304.0010 A13883.304.0010</p>	<p>Profilo elettrificato flessibile. Alimentazione 24V DC. Flexible electrified profile. Power supply 24V DC.</p> <p>IP20 ⚡</p> <p>Completo di n.4 box di fissaggio e kit di alimentazione. LED e driver non inclusi.</p> <p>Complete with 4 fixing boxes and power supply kit. LED and driver not included.</p>	









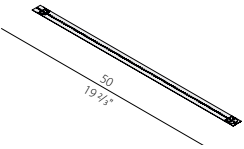

BOW

Maurizio Quargnale 2023

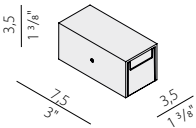
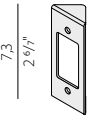
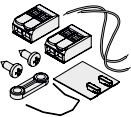
Registered Design

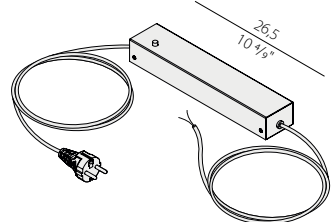
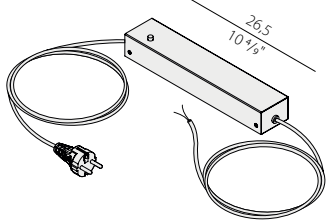
	CODICE CODE	FONTI LUMINOSE LIGHT SOURCES	kg
	YLB138.050.0510	<p>Modulo LED, 500mm (19,7") 98 LED 8W 24V DC 2700K Ra>90 800lm.  25cm (9 6/7").</p> <p>LED module, 500mm (19,7") 98 LED 8W 24V DC 2700K Ra>90 800lm.  25cm (9 6/7").</p> <p> </p> <p>Completo di n.2 molle di fissaggio. Complete with no. 2 fixing springs.</p>	
	YBF13801.007 YBF13806.007 YBF13883.007	<p>Box di fissaggio in alluminio pressofuso con cover di chiusura in alluminio estruso per profilo Bow, con finitura in colore bianco, nero satinato o legno. Die-cast aluminium fastening box with extruded aluminium end cover for Bow profile, in white, mat black or wood finish.</p>	
	YFA13801.90 YFA13806.90 YFA13883.90	<p>Staffa per fissaggio Bow in angolo a 90°, in acciaio con verniciatura poliaccrilica in colore bianco, nero satinato o per versione legno. Bracket for fixing Bow at 90° angle, made of steel with polyacrylic paint finish in white, mat black or for wood version.</p> <p>Utilizzare n.1 staffa per ogni box di fissaggio Use no. 1 bracket for each fixing box</p>	
	YKA13800.01	<p>Kit per alimentazione supplementare per composizioni multiple, costituito da scheda alimentazione 24V con n.1 molla di fissaggio, bloccacavo, cavi di alimentazione, morsetti. Additional power supply kit for multiple configurations, consisting of 24V power supply board with 1 fixing spring, cable clamp, power supply cables, terminal blocks.</p> <p></p>	
	YCD13806.300.060	<p>Box di alimentazione per Bow, con driver 60W/24V, con dimmer integrato e spina. Lunghezza 3m (118 1/5"). Power supply box for Bow, with 60W/24V driver, with integrated dimmer and plug. Length 3m (118 1/5").</p>	
	YCI13806.300.060	<p>Box di alimentazione per Bow, con driver 60W/24V on/off, con pulsante e spina. Lunghezza 3m (118 1/5"). Power supply box for Bow, with 60W/24V on/off driver, with button and plug. Length 3m (118 1/5").</p>	

Fotometrie disponibili www.panzeri.it / Photometric data available at www.panzeri.it

CODICI COLORI DISPONIBILI / COLOUR CODES AVAILABLE

01 bianco white **06** nero satinato mat black **83** legno wood



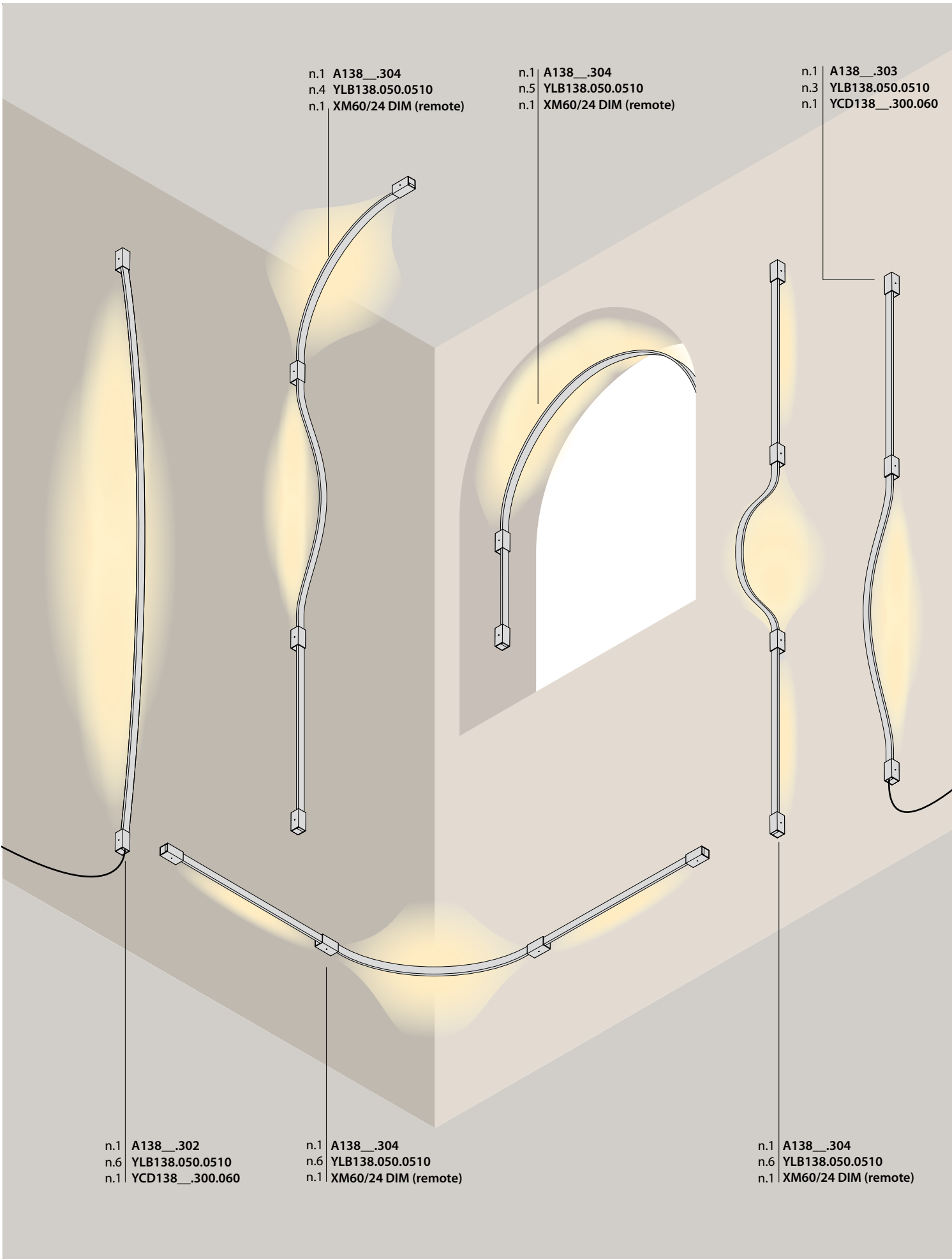

n.1 A138__304
n.4 YLB138.050.0510
n.1 XM60/24 DIM (remote)

n.1 A138__304
n.5 YLB138.050.0510
n.1 XM60/24 DIM (remote)

n.1 A138__303
n.3 YLB138.050.0510
n.1 YCD138__300.060

n.1 A138__302
n.6 YLB138.050.0510
n.1 YCD138__300.060

n.1 A138__304
n.6 YLB138.050.0510
n.1 XM60/24 DIM (remote)

n.1 A138__304
n.6 YLB138.050.0510
n.1 XM60/24 DIM (remote)



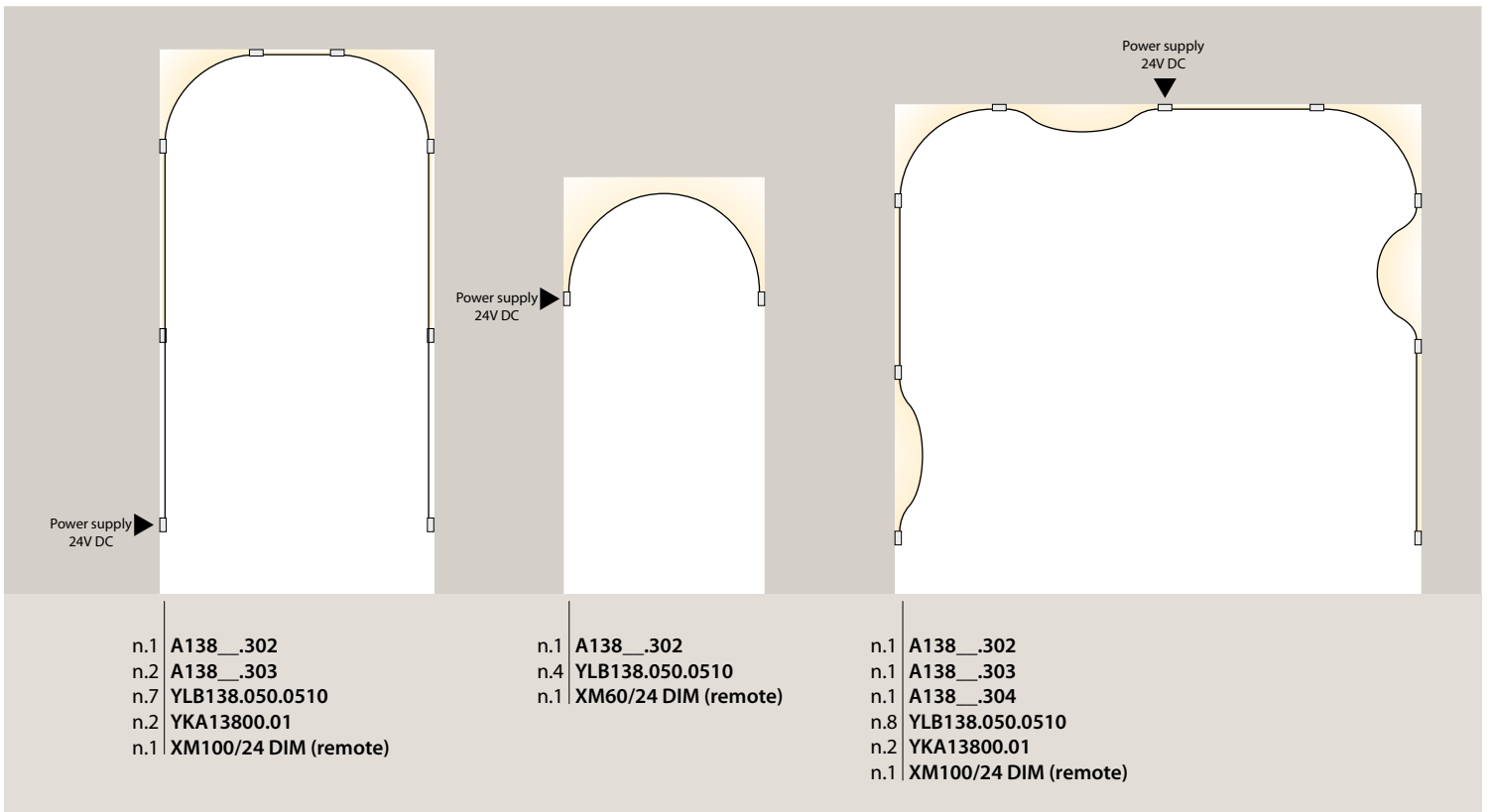





BROOKLYN LINE

Enzo Panzeri 2013



Sospensione a LED in alluminio estruso verniciato bianco, nero con riflettore e schermo.

Suspension LED in extruded aluminium, painted white, black with reflector and screen.

	CODICE CODE	FONTI LUMINOSE LIGHT SOURCES	kg
	L23301.100.0401	Potenza assorbita apparecchio / Luminaire power consumption 20W	2,12
	L23302.100.0401	Flusso luminoso apparecchio / Luminaire luminous flux 1142lm 3000K Ra>90 220-240V AC ON-OFF IP20 850° Fornito con diffusore opale e riflettore Supplied with opal diffuser and reflector	
	L23301.150.0401	Potenza assorbita apparecchio / Luminaire power consumption 29W	2,32
	L23302.150.0401	Flusso luminoso apparecchio / Luminaire luminous flux 1713lm 3000K Ra>90 220-240V AC ON-OFF IP20 850° Fornito con diffusore opale e riflettore Supplied with opal diffuser and reflector	

Fotometrie disponibili www.panzeri.it / Photometric data available at www.panzeri.it

CODICI COLORI DISPONIBILI / COLOUR CODES AVAILABLE

01 bianco
white

02 nero
black







BROOKLYN SPOT

Enzo Panzeri 2015

Registered Design



Spot orientabile nero o bianco completo di driver.

Adjustable black or white spot with driver included.

CODICE CODE	FONTI LUMINOSE LIGHT SOURCES	kg
-------------	------------------------------	----



P20301.035.2601

P20302.035.2601

Potenza assorbita apparecchio / Luminaire power consumption 10W

Flusso luminoso apparecchio / Luminaire luminous flux 698lm

1,05

IP20

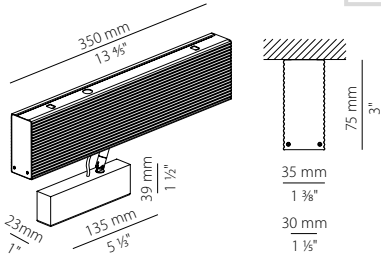

Fotometrie disponibili www.panzeri.it / Photometric data available at www.panzeri.it

CODICI COLORI DISPONIBILI / COLOUR CODES AVAILABLE

01 bianco
white

02 nero
black





BROOKLYN ROUND

Enzo Panzeri 2017



Lampada a sospensione e soffitto/parete in alluminio estruso curvato con schermo in policarbonato opale. Sorgente luminosa composta da modulo led a luce diretta e dimmerazione inserita nel rosone. Finitura con vernice poliacrilica in bianco, nero o ottone satinato e dettaglio del profilo a coste. Disponibile rosone per composizioni multiple di Brooklyn Round. Ideale per uffici, hall, zone living, grandi spazi.

Suspension and ceiling/wall lamp in extruded curved aluminum with opal polycarbonate screen. Light source made of LED module with direct light and dimmable driver in the canopy. Polyacrylic white, black or mat brass painted and ribbed lateral finish. Canopy for multiple configurations of Brooklyn Round is available. Ideal for offices, hall, living areas, and large areas.

	CODICE CODE	FONTI LUMINOSE LIGHT SOURCES	kg
	<p>L23101.360.0402 L23102.360.0402 L23119.360.0402</p>	<p>Potenza assorbita apparecchio / Luminaire power consumption 55W Flusso luminoso apparecchio / Luminaire luminous flux 2965lm 3000K Ra>90 220-240V AC dimmable (DALI/Push DIM)</p> <p> IP40 850°</p>	3,24
	<p>L23201.360.0402 L23202.360.0402 L23219.360.0402</p>	<p>Potenza assorbita apparecchio / Luminaire power consumption 109W Flusso luminoso apparecchio / Luminaire luminous flux 5931lm 3000K Ra>90 220-240V AC dimmable (DALI/Push DIM)</p> <p> IP40 850°</p>	5,78
	<p>L23101.180.0402 L23102.180.0402 L23119.180.0402</p>	<p>Potenza assorbita apparecchio / Luminaire power consumption 29W Flusso luminoso apparecchio / Luminaire luminous flux 1483lm 3000K Ra>90 220-240V AC dimmable (DALI/Push DIM)</p> <p> IP40 850°</p>	1,89
	<p>L23201.180.0402 L23202.180.0402 L23219.180.0402</p>	<p>Potenza assorbita apparecchio / Luminaire power consumption 55W Flusso luminoso apparecchio / Luminaire luminous flux 2965lm 3000K Ra>90 220-240V AC dimmable (DALI/Push DIM)</p> <p> IP40 850°</p>	3,38
	<p>XM231/23201L XM231/23202L XM231/23219L</p>	<p>Piastrina per sospensioni multiple. Plate for multiple suspensions.</p>	0,03



ROSONI BROOKLYN ROUND / BROOKLYN ROUND CANOPIES



Rosone per composizioni multiple di Brooklyn Round. Può alloggiare al suo interno un numero massimo di 4 driver di diverse potenze, da 4x60W/24V DALI / PUSH DIM a 2x60W/24V+2x150W/24V DALI / PUSH DIM. Gli apparecchi Brooklyn Round vanno ordinati senza rosone e driver. L'Ufficio Tecnico Panzeri è disponibile a supporto della progettazione.

Canopy for Brooklyn Round configurations. It carries a maximum of 4 drivers of different power: from 4 x60W/24V DALI / PUSH DIM to 2x60W/24V+2x150W/24V DALI / PUSH DIM. Brooklyn Round fixtures have to be ordered without canopy and driver. Panzeri Technical Department is available to support the design.

	CODICE CODE	FONTE LUMINOSE LIGHT SOURCES	kg
	XM23101.538.0099	Rosone per collegamento elettrico con 8	1,17
	XM23102.538.0099	uscite e per raggruppamento di 7 funi in	
	XM23119.538.0099	acciaio, per massimo 8 modelli Brooklyn Round.	

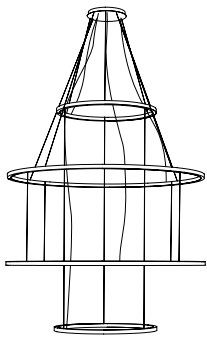

01 Esempio di composizione con 4 apparecchi:
Example of configuration with 4 fixtures:
N. 1 canopy
XM231__538.0099
N.2 Brooklyn Round
L232__360.0402 SPECIAL
N.2 Brooklyn Round
L231__360.0402 SPECIAL

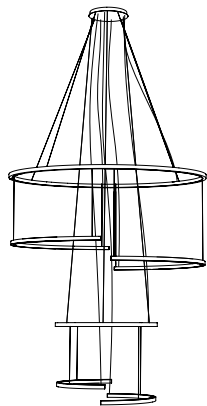

02 Esempio di composizione con 6 apparecchi:
Example of configuration with 6 fixtures:
N. 1 canopy XM231__538.0099
N.1 Brooklyn Round
L232__360.0402 SPECIAL
N.2 Brooklyn Round
L232__180.0402 SPECIAL
N.1 Brooklyn Round
L231__360.0402 SPECIAL
N.2 Brooklyn Round
L231__180.0402 SPECIAL

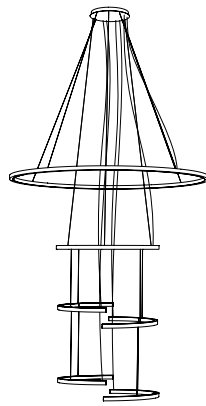

03 Esempio di composizione con 6 apparecchi:
Example of configuration with 6 fixtures:
N. 1 canopy
XM231__538.0099
N.1 Brooklyn Round
L232__360.0402 SPECIAL
N.1 Brooklyn Round
L231__360.0402 SPECIAL
N.4 Brooklyn Round
L231__180.0402 SPECIAL

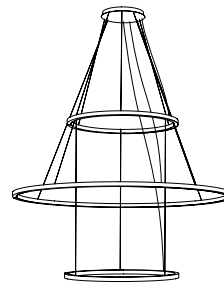

04 Esempio di composizione con 3 apparecchi:
Example of configuration with 3 fixtures:
N. 1 canopy
XM231__538.0099
N.1 Brooklyn Round
L232__360.0402 SPECIAL
N.2 Brooklyn Round
L231__360.0402 SPECIAL

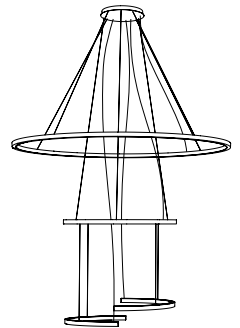

05 Esempio di composizione con 4 apparecchi:
Example of configuration with 4 fixtures:
N. 1 canopy
XM231__538.0099
N.1 Brooklyn Round
L232__360.0402 SPECIAL
N.1 Brooklyn Round
L231__360.0402 SPECIAL
N.2 Brooklyn Round
L231__180.0402 SPECIAL

Fotometrie disponibili www.panzeri.it / Photometric data available at www.panzeri.it

CODICI COLORI DISPONIBILI / COLOUR CODES AVAILABLE

01 bianco
white

02 nero
black

19 ottone satinato
mat brass



BROOKLYN ROUND

Enzo Panzeri 2017

	CODICE CODE	FONTE LUMINOSE LIGHT SOURCES	kg
	P23101.360.0402 P23102.360.0402 P23119.360.0402	Potenza assorbita apparecchio / Luminaire power consumption 55W Flusso luminoso apparecchio / Luminaire luminous flux 2965lm 3000K Ra>90 220-240V AC dimmable (DALI/Push DIM)	3,29
	P23201.360.0402 P23202.360.0402 P23219.360.0402	Potenza assorbita apparecchio / Luminaire power consumption 109W Flusso luminoso apparecchio / Luminaire luminous flux 5931lm 3000K Ra>90 220-240V AC dimmable (DALI/Push DIM)	5,83
	P23101.180.0402 P23102.180.0402 P23119.180.0402	Potenza assorbita apparecchio / Luminaire power consumption 29W Flusso luminoso apparecchio / Luminaire luminous flux 1483lm 3000K Ra>90 220-240V AC dimmable (DALI/Push DIM)	1,99
	P23201.180.0402 P23202.180.0402 P23219.180.0402	Potenza assorbita apparecchio / Luminaire power consumption 55W Flusso luminoso apparecchio / Luminaire luminous flux 2965lm 3000K Ra>90 220-240V AC dimmable (DALI/Push DIM)	3,38

Fotometrie disponibili www.panzeri.it / Photometric data available at www.panzeri.it

CODICI COLORI DISPONIBILI / COLOUR CODES AVAILABLE

Disponibili a richiesta LED 2700K / On request 2700K LED available

01 bianco
white

02 nero
black

19 ottone satinato
mat brass





CANDLE

Silvia Poma 2006



Lampada a sospensione costituita da rosone in metallo e vetro borosilicato filettato. Vetro satinato nella parte superiore e trasparente nella sezione inferiore. Emissione di luce diffusa generata da varie fonti luminose (modulo LED o G9). Rosone in metallo verniciato poliacrilico bianco customizzabile in colore, forma e dimensione. Ideale per lobby o grandi spazi residenziali.

Suspension lamp made of a metal canopy and threaded borosilicate glass. Frosted glass in the upper part and transparent in the lower section. Emission of diffused light provided by various light sources (LED module or G9). Metal canopy in white polyacrylic paint, customizable in color, shape and size. Ideal for lobby or large residential areas.

	CODICE CODE	FONTI LUMINOSE LIGHT SOURCES	kg
	L09501.000.0401	Potenza assorbita apparecchio / Luminaire power consumption 4W Flusso luminoso apparecchio / Luminaire luminous flux 238lm 3000K Ra>90 220-240V AC ON-OFF IP20	0,62
	L09501.000.0000	LED retrofit bulb G9 (L max 60mm - Ø max 17,5mm) max 48W G9 IP20	0,58
	M09501.000.0410	Potenza assorbita apparecchio / Luminaire power consumption 2,8W Flusso luminoso apparecchio / Luminaire luminous flux 238lm 3000K Ra>90 24V DC IP20 Fornito senza rosone e driver, per composizioni multiple Supplied without canopy and driver, for multiple configurations	0,37
	M09501.000.0000	LED retrofit bulb G9 (L max 60mm - Ø max 17,5mm) max 48W G9 IP20 Fornito senza rosone, per composizioni multiple Supplied without canopy, for multiple configurations	0,37
	M800	Appendimento in policarbonato per sospensione. Polycarbonate hook for suspension.	0,01

Fotometrie disponibili www.panzeri.it / Photometric data available at www.panzeri.it

CODICI COLORI DISPONIBILI / COLOUR CODES AVAILABLE

01 bianco
white

ROSONI E DECENTRAMENTI A PAGINA 171 / OFFSET AND CANOPIES PAGE 171





La famiglia Carl propone apparecchi installabili con rosone ad incasso nel soffitto, per applicazioni versatili che danno vita a geometrie di luce e volumi nello spazio. Disponibili in versione fissa oppure orientabile, sono adatti ad una grande varietà di applicazioni quali strutture ricettive, spazi residenziali, showroom e negozi. Il design sobrio e discreto, che permette di armonizzare stile e funzionalità, è arricchito dalla vasta gamma di finiture in colore bianco, nero, bronzo, ottone satinato e titanio. Progettati per ospitare i nuovi LED COB ad alta efficienza, offrono comfort visivo grazie allo snoot integrato e al vetro zigrinato di serie. Tutte le versioni sono fornite complete di driver.

Carl is a family of lighting fittings to install in the ceiling with a recessed canopy, for versatile applications that create geometries of light and volumes in the interior space. Available in a fixed or adjustable version, they suit a variety of applications amongst which reception halls, residential spaces, retail stores and show-rooms. The sober and discreet design enables to harmonize style and functionality, and is enriched by an extensive range of finishes in white, black, bronze, mat brass and titanium. Engineered to embed new high-efficiency COB LEDs, they provide visual comfort thanks to the integrated snoot and to the prismatic spread lens. All versions are supplied with a power supply.

	CODICE CODE	FONTI LUMINOSE LIGHT SOURCES	kg
	X12201.008.2501	Potenza assorbita apparecchio / Luminaire power consumption 12W	0,27
	X12202.008.2501	Flusso luminoso apparecchio / Luminaire luminous flux 1050lm	
	X12217.008.2501	3000K Ra>90 30° 350mA DC ON-OFF	
	X12219.008.2501	IP20 850°	
	X12230.008.2501	Fornito completo di driver ON-OFF Supplied with ON-OFF driver	
	X12301.007.2501	Potenza assorbita apparecchio / Luminaire power consumption 6,5W	0,11
	X12302.007.2501	Flusso luminoso apparecchio / Luminaire luminous flux 425lm	
	X12317.007.2501	3000K Ra>90 34° 700mA DC ON-OFF	
	X12319.007.2501	IP20 850°	
	X12330.007.2501	Fornito completo di driver ON-OFF Supplied with ON-OFF driver	
	X12301.010.2502	Potenza assorbita apparecchio / Luminaire power consumption 18W	0,29
	X12302.010.2502	Flusso luminoso apparecchio / Luminaire luminous flux 1436lm	
	X12317.010.2502	3000K Ra>90 30° 500mA DC dimmable (DALI/Push DIM)	
	X12319.010.2502	IP20 850°	
	X12330.010.2502	Fornito completo di driver DALI/Push DIM Supplied with DALI/Push DIM driver	

Fotometrie disponibili www.panzeri.it / Photometric data available at www.panzeri.it

UGR<16 in funzione delle condizioni di installazione / UGR<16 depending on installation conditions

CODICI COLORI DISPONIBILI / COLOUR CODES AVAILABLE

Disponibili a richiesta LED 2700K / On request 2700K LED available

- | | | | | |
|---------------------------|-------------------------|----------------------------|--|-------------------------------|
| 01 bianco
white | 02 nero
black | 17 bronzo
bronze | 19 ottone satinato
mat brass | 30 titanio
titanium |
|---------------------------|-------------------------|----------------------------|--|-------------------------------|







CARL

Officina Panzeri 2021



Modello che combina una coppia di faretto Carl direzionabili, per creare molteplici giochi di luce nell'ambiente. Applicabile a soffitto o parete, completa la gamma Carl a cui può essere accostato anche per le finiture disponibili di colore bianco, nero, bronzo, ottone satinato e titanio. Il driver integrato nella base offre la possibilità di regolare l'intensità luminosa tramite dispositivi 1-10V o Push DIM.

Lighting fitting that combines a pair of Carl adjustable projectors, to create multiple plays of light in the interior space. To install ceiling or wall mount, it complements the Carl family also thanks to the available finishes in white, black, bronze, mat brass and bronze. The power supply integrated in the base provides the possibility to dim the light intensity through 1-10V or Push DIM dimming protocol.

	CODICE CODE	FONTI LUMINOSE LIGHT SOURCES	kg
	P12501.033.0403	Potenza assorbita apparecchio / Luminaire power consumption 43W Flusso luminoso apparecchio / Luminaire luminous flux 2 x 1436lm 3000K Ra>90 30° 220-240V AC dimmable (1-10V/Push DIM) IP20	1,20
	P12502.033.0403		
	P12517.033.0403		
	P12519.033.0403		
	P12530.033.0403		

Fotometrie disponibili www.panzeri.it / Photometric data available at www.panzeri.it

UGR<16 in funzione delle condizioni di installazione / UGR<16 depending on installation conditions

CODICI COLORI DISPONIBILI / COLOUR CODES AVAILABLE

Disponibili a richiesta LED 2700K / On request 2700K LED available

- | | | | | |
|---------------------------|-------------------------|----------------------------|--|-------------------------------|
| 01 bianco
white | 02 nero
black | 17 bronzo
bronze | 19 ottone satinato
mat brass | 30 titanio
titanium |
|---------------------------|-------------------------|----------------------------|--|-------------------------------|





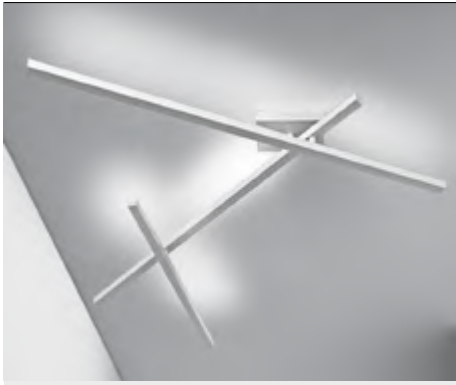

Disponibile nelle versioni da parete o a soffitto. Formata da metallo tagliato a laser, piegato e successivamente saldata con filo d'argento. Versione a soffitto con meccanismo rotatorio tornito dal pieno. Diffusione di luce indiretta attraverso schermo trasparente di protezione. Fonte luminosa costituita da modulo LED. Dimmerazione 1-10V/Push DIM di serie sulla versione con 3 bracci. Lampada finita con vernice poliaccrilica in bianco o nero. La versione a soffitto è disponibile con 2 o 3 sezioni rotanti (350°), mentre quella a parete è una sezione fissa. Ideale per locali ampi e difficili da illuminare.

Ceiling or wall lamp in laser-cut metal folded and then welded with silver thread. The ceiling version has a rotary mechanism turned from solid. Indirect light through transparent screen. Light source consisting of LED module. The version with 3 arms is provided with dimming 1-10V/Push DIM driver. Lamp painted in white or black polyacrylic paint. The ceiling version has 2 or 3 rotating sections (350°), while the wall version is a fixed section. Ideal for large rooms difficult to illuminate.

	CODICE CODE	FONTI LUMINOSE LIGHT SOURCES	kg
	P06401.003.0403 P06402.003.0403	Potenza assorbita apparecchio / Luminaire power consumption 56W Flusso luminoso apparecchio / Luminaire luminous flux 5420lm 3000K Ra>90 220-240V AC dimmable (1-10V/Push DIM) IP20 850°	8,30
	P06401.002.0401 P06402.002.0401	Potenza assorbita apparecchio / Luminaire power consumption 28,5W Flusso luminoso apparecchio / Luminaire luminous flux 2519lm 3000K Ra>90 220-240V AC ON-OFF IP20 850°	4,08
	A06401.000.0401 A06402.000.0401	Potenza assorbita apparecchio / Luminaire power consumption 13W Flusso luminoso apparecchio / Luminaire luminous flux 1025lm 3000K Ra>90 220-240V AC ON-OFF IP20 850°	1,79

Fotometrie disponibili www.panzeri.it / Photometric data available at www.panzeri.it

CODICI COLORI DISPONIBILI / COLOUR CODES AVAILABLE

- 01** bianco / white
- 02** nero / black



A064_...000.0401

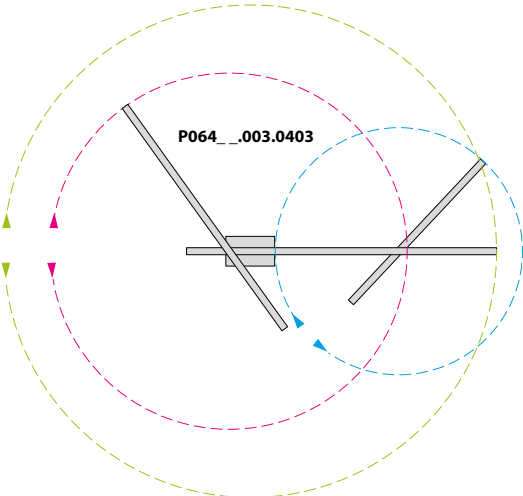
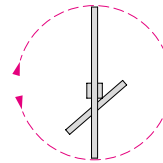

Rotazione dei bracci di 350°

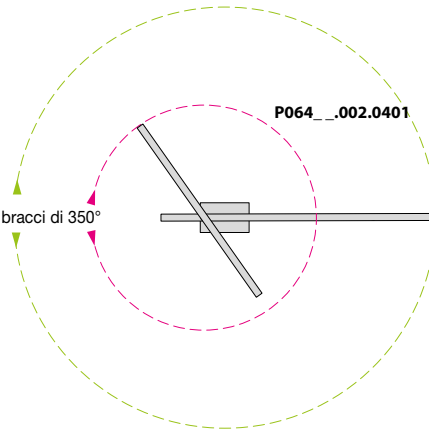

Rotation of arms at 350°







Lampada a parete in metallo tagliato a laser con diffusore in vetro acidato. Luce sia diretta che indiretta ottenuta da fonte luminosa LED. Fascia metallica rifinita con vernice poliaccrilica bianca, ottone satinato o con decorazione a mano in foglia oro e fissata alla struttura senza l'ausilio di viti a vista attraverso sistema elastico. Le fasce assemblate creano un simmetrico gioco di luci e ombre sulla struttura. Ideale per corridoi o uso residenziale.

Wall lamp in laser-cut metal and glass diffuser. Direct and indirect LED light. Metal cover in white or mat brass and fixed without any visible screw thanks to an elastic system. The assembled covers create a symmetrical play of lights and shadows on the structure. Ideal for corridors or residential use.

	CODICE CODE	FONTI LUMINOSE LIGHT SOURCES	kg
	A04901.030.0101	Potenza assorbita apparecchio / Luminaire power consumption 20W	1,22
	A04919.030.0101	Flusso luminoso apparecchio / Luminaire luminous flux 2340lm	
	A04921.030.0101	3000K Ra>80 220-240V AC ON-OFF IP20	
	A04901.030.0102	Potenza assorbita apparecchio / Luminaire power consumption 20W	1,22
	A04919.030.0102	Flusso luminoso apparecchio / Luminaire luminous flux 2340lm	
	A04921.030.0102	3000K Ra>80 220-240V AC dimmable (DALI/Push DIM) IP20	
	A04901.060.0101	Potenza assorbita apparecchio / Luminaire power consumption 40W	2,32
	A04919.060.0101	Flusso luminoso apparecchio / Luminaire luminous flux 4680lm	
	A04921.060.0101	3000K Ra>80 220-240V AC ON-OFF IP20	
	A04901.060.0102	Potenza assorbita apparecchio / Luminaire power consumption 40W	2,32
	A04919.060.0102	Flusso luminoso apparecchio / Luminaire luminous flux 4680lm	
	A04921.060.0102	3000K Ra>80 220-240V AC dimmable (DALI/Push DIM) IP20	

Fotometrie disponibili www.panzeri.it / Photometric data available at www.panzeri.it

CODICI COLORI DISPONIBILI / COLOUR CODES AVAILABLE

Disponibili a richiesta LED 2700K / On request 2700K LED available

01 bianco
white

19 ottone satinato
mat brass

21 foglia oro
gold leaf







Lampada da parete e soffitto in vetro soffiato satinato bianco. Struttura a scomparsa (per i modelli ø 30 cm e ø 40 cm) in metallo verniciato bianco. Struttura a vista (per il modello ø 50 cm) in metallo verniciato bianco.

Wall and ceiling lamp made of mat blown glass. Invisible white metal part for ø 30 cm and ø 40 cm size. Visible white metal part for ø 50 size.

	CODICE CODE	FONTI LUMINOSE LIGHT SOURCES	kg
	P06601.030.0401	Potenza assorbita apparecchio / Luminaire power consumption 13W Flusso luminoso apparecchio / Luminaire luminous flux 932lm 3000K Ra>90 220-240V AC ON-OFF IP20	1,37
	P06601.030.0000	LED retrofit bulb E27 (L max 100mm - Ø max 55mm) max 53W E27 IP20	1,37
	P06601.040.0401	Potenza assorbita apparecchio / Luminaire power consumption 19W Flusso luminoso apparecchio / Luminaire luminous flux 1252lm 3000K Ra>90 220-240V AC ON-OFF IP20	2,64
	P06601.040.0000	2x LED retrofit bulb E27 (L max 100mm - Ø max 55mm) 2x max 53W E27 IP20	2,64
	P06601.050.0401	Potenza assorbita apparecchio / Luminaire power consumption 19W Flusso luminoso apparecchio / Luminaire luminous flux 1252lm 3000K Ra>90 220-240V AC ON-OFF IP20	4,00
	P06601.050.0000	2x LED retrofit bulb E27 (L max 100mm - Ø max 55mm) 2x max 53W E27 IP20	4,00

Fotometrie disponibili www.panzeri.it / Photometric data available at www.panzeri.it

CODICI COLORI DISPONIBILI / COLOUR CODES AVAILABLE

Disponibili a richiesta LED 2700K / On request 2700K LED available

01 bianco
white







ELY, EMY, EVY

Silvia Poma 2019



Lampade a sospensione in vetro soffiato satinato, caratterizzate dal trattamento del vetro secondo le tecniche rigadin, balloton e ballotondo che conferiscono rispettivamente ad Ely una finitura rigata, ad Emy una trama romboidale e ad Evy un pattern sferico. Rosone in metallo rifinito con vernice poliaccrilica in ottone satinato. Emissione di luce diffusa con attacco G9 per lampada LED retrofit disponibile a catalogo da ordinare separatamente. Cristallo, acciaio, ambra, bronzo, tabacco e verde le colorazioni vetro disponibili. Cavo elettrico trasparente. Disponibile rosone a scomparsa e rosoni per sospensioni multiple.

Suspension lamps in mat blown glass, characterized by the treatment of glass according to decoration techniques rigadin, balloton, and ballotondo which gives Ely a striped finish, Emy a rhomboidal texture and Evy a spherical pattern. Ceiling canopy in mat brass polyacrylic paint. Diffused light in LED bulb G9 available in catalog, to be ordered separately. Crystal, steel, amber, bronze, tobacco and green are the glass colors available. Transparent electrical cable. Recessed canopy and canopies for multiple suspensions are available.

	CODICE CODE	FONTI LUMINOSE LIGHT SOURCES	kg
	L10072.000.0000	LED retrofit bulb G9 (L max 60mm - Ø max 17,5mm)	0,59
	L10073.000.0000	max 48W G9	
	L10074.000.0000	IP40	
	L10075.000.0000		
	L10076.000.0000		
	L10077.000.0000		
	M10072.000.0000	LED retrofit bulb G9 (L max 60mm - Ø max 17,5mm)	0,50
	M10073.000.0000	max 48W G9	
	M10074.000.0000	IP40	
	M10075.000.0000	Fornito senza rosone per composizioni multiple	
	M10076.000.0000	Supplied without canopy for multiple configurations	
	M10077.000.0000		
	M800	Appendimento in policarbonato per sospensione. Polycarbonate hook for suspension.	0,01
	XM5/G9LED	Lampada LED G9 4W 220-240V AC 3000K Ra>80 340lm, non dimmerabile. LED lamp G9 4W 220-240V AC 3000K Ra>80 340lm, not dimmable.	0,01

Fotometrie disponibili www.panzeri.it / Photometric data available at www.panzeri.it

CODICI COLORI DISPONIBILI / COLOUR CODES AVAILABLE

72 ottone satinato/
diffusore cristallo
mat brass/
crystal diffuser

73 ottone satinato/
diffusore acciaio
mat brass/
steel diffuser

74 ottone satinato/
diffusore ambra
mat brass/
amber diffuser

75 ottone satinato/
diffusore bronzo
mat brass/bronze
diffuser

76 ottone satinato/
diffusore tabacco
mat brass/tobacco
diffuser

77 ottone satinato/
diffusore verde
mat brass/
green diffuser

ROSONI E DECENTRAMENTI A PAGINA 171 / OFFSET AND CANOPIES PAGE 171



ELY, EMY, EVY

Silvia Poma 2019



Lampade a sospensione in vetro soffiato satinato, caratterizzate dal trattamento del vetro secondo le tecniche rigadin, balloton, e ballotondo che conferiscono rispettivamente ad Ely una finitura rigata, ad Emy una trama romboidale e ad Evy un pattern sferico. Rosone in metallo rifinito con vernice poliaccrilica in ottone satinato. Emissione di luce diffusa con attacco G9 per lampada LED retrofit disponibile a catalogo da ordinare separatamente. Cristallo, acciaio, ambra, bronzo, tabacco e verde le colorazioni vetro disponibili. Cavo elettrico trasparente. Disponibile rosone a scomparsa e rosone per sospensioni multiple.

Suspension lamps in mat blown glass, characterized by the treatment of glass according to decoration techniques rigadin, balloton, and ballotondo which gives Ely a striped finish, Emy a rhomboidal texture and Evy a spherical pattern. Ceiling canopy in mat brass polyacrylic paint. Diffused light in LED bulb G9 available in catalog, to be ordered separately. Crystal, steel, amber, bronze, tobacco and green are the glass colors available. Transparent electrical cable. Recessed canopy and canopies for multiple suspensions are available.

	CODICE CODE	FONTE LUMINOSE LIGHT SOURCES	kg
	L10172.000.0000	LED retrofit bulb G9 (L max 60mm - Ø max 17,5mm)	0,67
	L10173.000.0000	max 48W G9	
	L10174.000.0000	IP40	
	L10175.000.0000		
	L10176.000.0000		
	M10172.000.0000	LED retrofit bulb G9 (L max 60mm - Ø max 17,5mm)	0,58
	M10173.000.0000	max 48W G9	
	M10174.000.0000	IP40	
	M10175.000.0000	Fornito senza rosone per composizioni multiple	
	M10176.000.0000	Supplied without canopy for multiple configurations	
	M800	Appendimento in policarbonato per sospensione. Polycarbonate hook for suspension.	0,01
	XM5/G9LED	Lampada LED G9 4W 220-240V AC 3000K Ra>80 340lm, non dimmerabile. LED lamp G9 4W 220-240V AC 3000K Ra>80 340lm, not dimmable.	0,01

Fotometrie disponibili www.panzeri.it / Photometric data available at www.panzeri.it

CODICI COLORI DISPONIBILI / COLOUR CODES AVAILABLE

72 ottone satinato
diffusore cristallo
mat brass
crystal diffuser

73 ottone satinato/
diffusore acciaio
mat brass/
steel diffuser

74 ottone satinato/
diffusore ambra
mat brass/
amber diffuser

75 ottone satinato/
diffusore bronzo
mat brass/bronze
diffuser

76 ottone satinato/
diffusore tabacco
mat brass/tobacco
diffuser

77 ottone satinato/
diffusore verde
mat brass/
green diffuser

ROSONI E DECENTRAMENTI A PAGINA 171 / OFFSET AND CANOPIES PAGE 171



ELY, EMY, EVY

Silvia Poma 2019



Lampade a sospensione in vetro soffiato satinato, caratterizzate dal trattamento del vetro secondo le tecniche rigadin, balloton, e ballotondo che conferiscono rispettivamente ad Ely una finitura rigata, ad Emy una trama romboidale e ad Evy un pattern sferico. Rosone in metallo rifinito con vernice poliaccrilica in ottone satinato. Emissione di luce diffusa con attacco G9 per lampada LED retrofit disponibile a catalogo da ordinare separatamente. Cristallo, acciaio, ambr, bronzo, tabacco e verde le colorazioni vetro disponibili. Cavo elettrico trasparente. Disponibile rosone a scomparsa e rosone per sospensioni multiple.

Suspension lamps in mat blown glass, characterized by the treatment of glass according to decoration techniques rigadin, balloton, and ballotondo which gives Ely a striped finish, Emy a rhomboidal texture and Evy a spherical pattern. Ceiling canopy in mat brass polyacrylic paint. Diffused light in LED bulb G9 available in catalog, to be ordered separately. Crystal, steel, amber, bronze, tobacco and green are the glass colors available. Transparent electrical cable. Recessed canopy and canopies for multiple suspensions are available.

	CODICE CODE	FONTI LUMINOSE LIGHT SOURCES	kg
	L10272.000.0000	LED retrofit bulb G9 (L max 60mm - Ø max 17,5mm)	0,82
	L10273.000.0000	max 48W G9	
	L10274.000.0000	IP40	
	L10275.000.0000		
	L10276.000.0000		
	L10277.000.0000		
	M10272.000.0000	LED retrofit bulb G9 (L max 60mm - Ø max 17,5mm)	0,74
	M10273.000.0000	max 48W G9	
	M10274.000.0000	IP40	
	M10275.000.0000	Fornito senza rosone per composizioni multiple	
	M10276.000.0000	Supplied without canopy for multiple configurations	
	M10277.000.0000		
	M800	Appendimento in policarbonato per sospensione. Polycarbonate hook for suspension.	0,01
	XM5/G9LED	Lampada LED G9 4W 220-240V AC 3000K Ra>80 340lm, non dimmerabile. LED lamp G9 4W 220-240V AC 3000K Ra>80 340lm, not dimmable.	0,01

Fotometrie disponibili www.panzeri.it / Photometric data available at www.panzeri.it

CODICI COLORI DISPONIBILI / COLOUR CODES AVAILABLE

72 ottone satinato/
diffusore cristallo
mat brass/
crystal diffuser

73 ottone satinato/
diffusore acciaio
mat brass/
steel diffuser

74 ottone satinato/
diffusore ambr
mat brass/
amber diffuser

75 ottone satinato/
diffusore bronzo
mat brass/bronze
diffuser

76 ottone satinato/
diffusore tabacco
mat brass/tobacco
diffuser

77 ottone satinato/
diffusore verde
mat brass/
green diffuser

ROSONI E DECENTRAMENTI A PAGINA 171 / OFFSET AND CANOPIES PAGE 171







FIREFLY IN THE SKY

Matteo Thun 2019

Registered Design



Firefly in the sky è un apparecchio a batteria da tavolo. La testa removibile racchiude sistema di aggancio magnetico, batteria ricaricabile tramite USB-C, sorgente LED e comando Step DIM a 5 regolazioni di intensità luminosa. In funzione delle condizioni di utilizzo per una ricarica di circa 4 ore si stima un'autonomia di circa 6 ore con intensità della luce al 100% e di circa 24 ore con intensità della luce al 25%. Base antiscivolo già in dotazione. Verde oliva materico, bianco soft materico, terracotta naturale materico e corten si aggiungono alle finiture disponibili nero satinato, bronzo e champagne.

Firefly in the sky is a battery table lamp. The removable head contains magnetic coupling system, rechargeable battery via USB-C, LED source and Step DIM control with 5 light intensity settings. Depending on the conditions of use for a recharge of approximately 4 hours, an autonomy of approximately 6 hours is estimated with 100% light intensity and approximately 24 hours with 25% light intensity. Anti-slip base included. Textured olive green, textured soft white, textured natural terracotta and corten are added to mat black, bronze and champagne finishes available.

NOVELTY	CODICE CODE	FONTI LUMINOSE LIGHT SOURCES	kg
---------	-------------	------------------------------	----

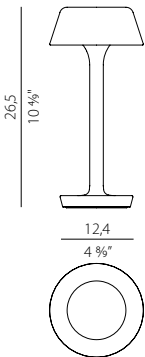

- C07805.011.0514**
- C07806.011.0514**
- C07816.011.0514**
- C07817.011.0514**
- C07827.011.0514**
- C07828.011.0514**
- C07829.011.0514**

Potenza assorbita apparecchio / Luminaire power consumption 2W
 Flusso luminoso apparecchio / Luminaire luminous flux 134lm
 2700K Ra>90 5V DC battery Dimmable (Step DIM)

IP65

Interruttore incluso / Switch included

In funzione delle condizioni di utilizzo per una ricarica di circa 4 ore si stima un'autonomia di circa 6 ore con intensità della luce al 100% e di circa 24 ore con intensità della luce al 25%. Indicatore LED per lo stato di carica. La carica avviene tramite USB-C. Caricabatteria e cavetto inclusi.

Depending on the conditions of use for a recharge of approximately 4 hours, an autonomy of approximately 6 hours is estimated with 100% light intensity and approximately 24 hours with 25% light intensity. LED indicator for the load status. Charging takes place via USB-C. Battery charger and cable Included.

YRM07802.010

Vassoio per ricarica multipla di massimo 10 modelli Firefly in the Sky. Multiple charging tray for up to 10 Firefly in the Sky models.

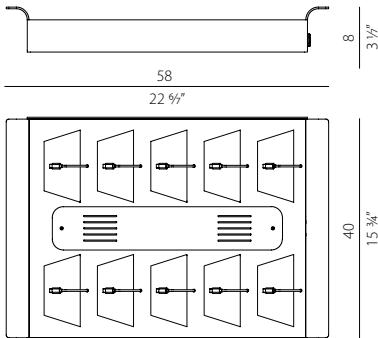

Fotometrie disponibili www.panzeri.it / Photometric data available at www.panzeri.it

CODICI COLORI DISPONIBILI / COLOUR CODES AVAILABLE

- | | | | | | | | |
|-------------------------------|-----------------------------------|-------------------------|-------------------------|---|--|--|----------------------|
| 05 champagne champagne | 06 nero satinato mat black | 16 corten corten | 17 bronzo bronze | 27 verde oliva materico textured olive green | 28 bianco soft materico textured soft white | 29 terracotta naturale materico textured natural terracotta | 02 nero black |
|-------------------------------|-----------------------------------|-------------------------|-------------------------|---|--|--|----------------------|



reddot winner 2020





Lampada a sospensione e a parete ad emissione diretta e indiretta. Sorgente luminosa LED, con driver ON-OFF con accensione separata o DALI/Push DIM. Finitura con vernice poliaccrilica in bianco o nero e finitura frontale del profilo liscia. Schermo in policarbonato estruso opale o microprismatico. Ideale per uffici, corridoi, scale.

Wall and suspension luminaire with direct and indirect light emission. Light source made of LED module with separate switching ON-OFF or DALI/Push DIM integrated drivers. Finish in polyacrylic paint in white or black and smooth front finish of the profile. Diffusor in opal or micro prismatic polycarbonate. Ideal for offices, corridors, stairways.

	CODICE CODE	FONTI LUMINOSE LIGHT SOURCES	kg
	L24647.150.0401	Potenza assorbita apparecchio / Luminaire power consumption 56W Flusso luminoso apparecchio / Luminaire luminous flux 4541lm 3000K Ra>90 60° / 87° 220-240V AC ON-OFF LED IP40 Fornito con predisposizione per doppia accensione, n.2 diffusori opali e n.1 diffusore microprismatico Supplied with predisposition for double switch, n.2 opal diffusers and n.1 microprismatic diffuser	5,08
	L24649.150.0401	Potenza assorbita apparecchio / Luminaire power consumption 56W Flusso luminoso apparecchio / Luminaire luminous flux 4541lm 3000K Ra>90 60° / 87° 220-240V AC ON-OFF LED IP40 Fornito con predisposizione per doppia accensione, n.2 diffusori opali e n.1 diffusore microprismatico Supplied with predisposition for double switch, n.2 opal diffusers and n.1 microprismatic diffuser	5,08
	L24647.200.0401	Potenza assorbita apparecchio / Luminaire power consumption 72W Flusso luminoso apparecchio / Luminaire luminous flux 6055lm 3000K Ra>90 60° / 87° 220-240V AC ON-OFF LED IP40 Fornito con predisposizione per doppia accensione, n.2 diffusori opali e n.1 diffusore microprismatico Supplied with predisposition for double switch, n.2 opal diffusers and n.1 microprismatic diffuser	6,45
	L24649.200.0402	Potenza assorbita apparecchio / Luminaire power consumption 70W Flusso luminoso apparecchio / Luminaire luminous flux 6055lm 3000K Ra>90 60° / 87° 220-240V AC dimmable (DALI/Push DIM) LED IP40 Fornito con n.2 diffusori opali e n.1 diffusore microprismatico Supplied with n.2 opal diffusers and n.1 microprismatic diffuser	6,45

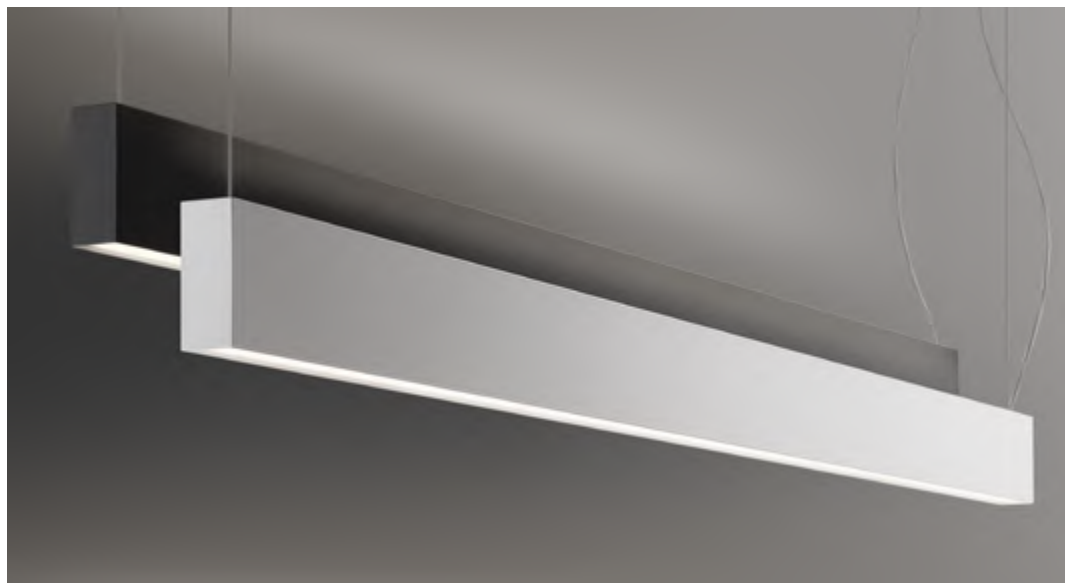



	CODICE CODE	FONTI LUMINOSE LIGHT SOURCES	kg
	A24646.025.0401 A24648.025.0401	Potenza assorbita apparecchio / Luminaire power consumption 11W Flusso luminoso apparecchio / Luminaire luminous flux 614lm 3000K Ra>90 220-240V AC ON-OFF LED IP40 Fornito con n.2 diffusori opali Supplied with n.2 opal diffusers	0,86
	A24646.050.0401 A24648.050.0401	Potenza assorbita apparecchio / Luminaire power consumption 19W Flusso luminoso apparecchio / Luminaire luminous flux 1228lm 3000K Ra>90 220-240V AC ON-OFF LED IP40 Fornito con n.2 diffusori opali Supplied with n.2 opal diffusers	1,30
	A24646.050.0402 A24648.050.0402	Potenza assorbita apparecchio / Luminaire power consumption 19W Flusso luminoso apparecchio / Luminaire luminous flux 1228lm 3000K Ra>90 220-240V AC dimmable (DALI/Push DIM) LED IP40 Fornito con n.2 diffusori opali Supplied with n.2 opal diffusers	1,32
	A24646.100.0401 A24648.100.0401	Potenza assorbita apparecchio / Luminaire power consumption 38W Flusso luminoso apparecchio / Luminaire luminous flux 2456lm 3000K Ra>90 220-240V AC ON-OFF LED IP40 Doppia accensione. Fornito con n.2 diffusori opali Double switch. Supplied with n.2 opal diffusers	2,60
	A24646.100.0402 A24648.100.0402	Potenza assorbita apparecchio / Luminaire power consumption 36W Flusso luminoso apparecchio / Luminaire luminous flux 2456lm 3000K Ra>90 220-240V AC dimmable (DALI/Push DIM) LED IP40 Fornito con n.2 diffusori opali Supplied with n.2 opal diffusers	2,64
	A24646.150.0401 A24648.150.0401	Potenza assorbita apparecchio / Luminaire power consumption 56W Flusso luminoso apparecchio / Luminaire luminous flux 3683lm 3000K Ra>90 220-240V AC ON-OFF LED IP40 Fornito con predisposizione per doppia accensione, n.2 diffusori opali Supplied with predisposition for double switch, n. 2 opal diffusers	3,62
	A24646.150.0402 A24648.150.0402	Potenza assorbita apparecchio / Luminaire power consumption 54W Flusso luminoso apparecchio / Luminaire luminous flux 3683lm 3000K Ra>90 220-240V AC dimmable (DALI/Push DIM) LED IP40 Fornito con n.2 diffusori opali Supplied with n.2 opal diffusers	3,92

Fotometrie disponibili www.panzeri.it / Photometric data available at www.panzeri.it

CODICI COLORI DISPONIBILI / COLOUR CODES AVAILABLE

47 bianco/schermo prismato / white/prismatic screen
 46 bianco/schermo opalino / white/opal screen
 48 nero/schermo opalino / black/opal screen
 49 nero/schermo prismato / black/prismatic screen







Lampada a sospensione, tavolo o soffitto costituita da vetro opale satinato soffiato e montatura in metallo rifinita con vernice poliaccrilica color bianco. Emissione di luce diffusa con possibilità di scelta di varie fonti luminose (LED, G9, E27). Omogenea diffusione della luce all'interno del vetro, senza zone in ombra. Ideale per un uso residenziale o per aree lobby in composizioni multiple.

Suspension, table and ceiling lamps in blown opal glass. Metal frame in white polyacrylic paint. Diffused light provided by different light sources (LED, G9, E27). Perfect and homogeneous distribution of the light, without any shadow. Ideal for residential use or for lobby areas in multiple compositions.

	CODICE CODE	FONTI LUMINOSE LIGHT SOURCES	kg
	L06501.022.0401	Potenza assorbita apparecchio / Luminaire power consumption 11W Flusso luminoso apparecchio / Luminaire luminous flux 929lm 3000K Ra>90 220-240V AC ON-OFF IP20	1,13
	L06501.022.0000	LED retrofit bulb G9 (L max 60mm - Ø max 17,5mm) max 60W G9 IP20	1,20
	L06501.037.0402	Potenza assorbita apparecchio / Luminaire power consumption 27W Flusso luminoso apparecchio / Luminaire luminous flux 2525lm 3000K Ra>90 220-240V AC dimmable (DALI/Push DIM) IP20	3,80
	L06501.037.0000	LED retrofit bulb E27 (L max 140mm - Ø max 65mm) max 150W E27 IP20	3,80
	L06501.045.0402	Potenza assorbita apparecchio / Luminaire power consumption 27W Flusso luminoso apparecchio / Luminaire luminous flux 2525lm 3000K Ra>90 220-240V AC dimmable (DALI/Push DIM) IP20	4,70
	L06501.045.0000	LED retrofit bulb E27 (L max 140mm - Ø max 65mm) max 150W E27 IP20	5,30
	P06501.037.0402	Potenza assorbita apparecchio / Luminaire power consumption 20W Flusso luminoso apparecchio / Luminaire luminous flux 1840lm 3000K Ra>90 220-240V AC dimmable (DALI/Push DIM) IP20	3,40
	P06501.037.0000	LED retrofit bulb E27 (L max 100mm - Ø max 55mm) max 150W E27 IP20	3,40
	P06501.045.0402	Potenza assorbita apparecchio / Luminaire power consumption 20W Flusso luminoso apparecchio / Luminaire luminous flux 1840lm 3000K Ra>90 220-240V AC dimmable (DALI/Push DIM) IP20	5,12
	P06501.045.0000	LED retrofit bulb E27 (L max 100mm - Ø max 55mm) max 150W E27 IP20	5,12
	C06501.022.0401	Potenza assorbita apparecchio / Luminaire power consumption 11W Flusso luminoso apparecchio / Luminaire luminous flux 692lm 3000K Ra>90 220-240V AC ON-OFF IP40	0,98

Fotometrie disponibili www.panzeri.it / Photometric data available at www.panzeri.it

CODICI COLORI DISPONIBILI / COLOUR CODES AVAILABLE

01 bianco
white





Lampada a sospensione e soffitto con diffusore microprismato a luminanza controllata. Versione a soffitto con emissione diretta attraverso modulo LED disponibile anche tunable white. La versione sospensione combina emissione diretta e indiretta dimmerabili. Corpo lampada in alluminio tornito rifinito con vernice poliaccrilica nelle versioni esterno nero e interno oro o esterno bianco e interno oro. Possibili colori custom su richiesta. Ideale per hall, zone living, grandi spazi, e uffici.

Suspension and ceiling lamp with microprismatic polycarbonate screen for controlled luminance. Ceiling version with direct light through LED modules also available tunable white. The suspension combines dimmable direct and indirect light. Lamp structure in turned aluminium finished in polyacrylic painted outside black and gold inside or outside white and gold inside. Custom colors are available on request. Ideal for halls, living areas, and public spaces and offices.

	CODICE CODE	FONTI LUMINOSE LIGHT SOURCES	kg
	L09280.050.0402	Potenza assorbita apparecchio / Luminaire power consumption 36W	6,27
	L09281.050.0402	Flusso luminoso apparecchio / Luminaire luminous flux 2916lm 3000K Ra>90 220-240V AC dimmable (DALI/Push DIM) IP20	
	L09280.080.0402	Potenza assorbita apparecchio / Luminaire power consumption 82W	10,97
	L09281.080.0402	Flusso luminoso apparecchio / Luminaire luminous flux 7782lm 3000K Ra>90 220-240V AC dimmable (DALI/Push DIM) IP20	
	P09280.050.0402	Potenza assorbita apparecchio / Luminaire power consumption 25W	5,08
	P09281.050.0402	Flusso luminoso apparecchio / Luminaire luminous flux 1877lm 3000K Ra>90 220-240V AC dimmable (DALI/Push DIM) IP20	
	P09280.050.9017	Potenza assorbita apparecchio / Luminaire power consumption 30W	5,08
	P09281.050.9017	Flusso luminoso apparecchio / Luminaire luminous flux 1794lm min. / 2046lm max 2700-6500K Ra>90 220-240V AC tunable white IP20 Bianco dinamico, driver DALI DT8 / Switch dim / Color switch Tunable white, driver DALI DT8 / Switch dim / Color switch	
	P09280.080.0402	Potenza assorbita apparecchio / Luminaire power consumption 71W	10,07
	P09281.080.0402	Flusso luminoso apparecchio / Luminaire luminous flux 6743lm 3000K Ra>90 220-240V AC dimmable (DALI/Push DIM) IP20	
	P09280.080.9017	Potenza assorbita apparecchio / Luminaire power consumption 69W	10,07
	P09281.080.9017	Flusso luminoso apparecchio / Luminaire luminous flux 6518lm min. / 7190lm max 2700-6500K Ra>90 220-240V AC tunable white IP20 Bianco dinamico, driver DALI DT8 / Switch dim / Color switch Tunable white, driver DALI DT8 / Switch dim / Color switch	

Fotometrie disponibili www.panzeri.it / Photometric data available at www.panzeri.it

UGR<19 in funzione delle condizioni di installazione / UGR<19 depending on installation conditions

CODICI COLORI DISPONIBILI / COLOUR CODES AVAILABLE

80 nero/oro
black/gold

81 bianco/oro
white/gold



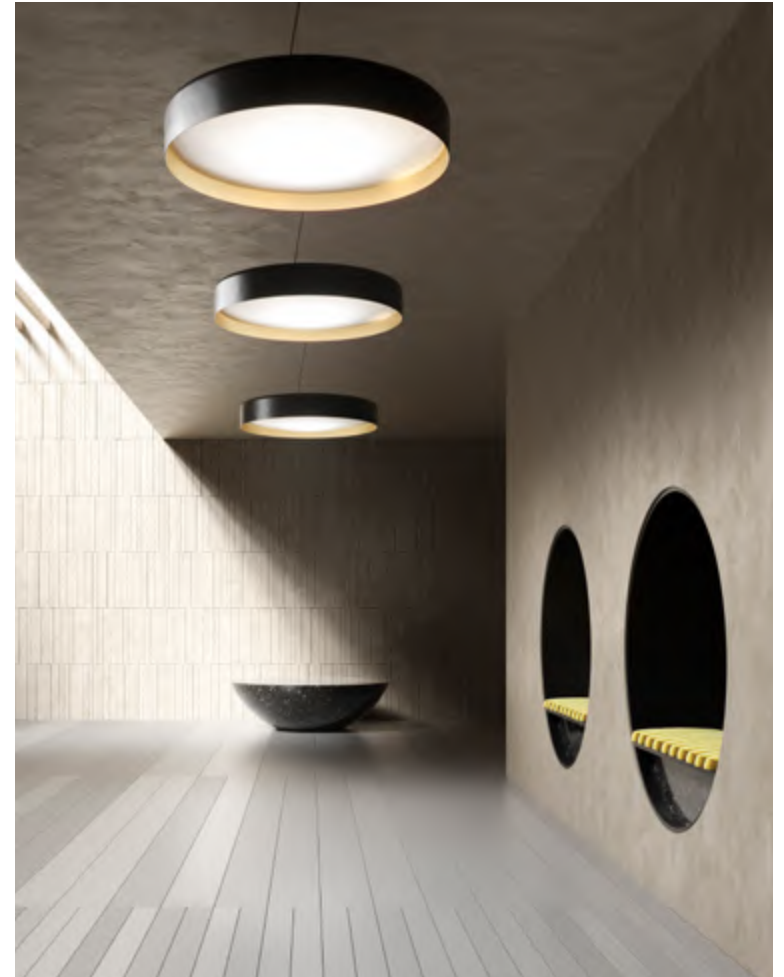

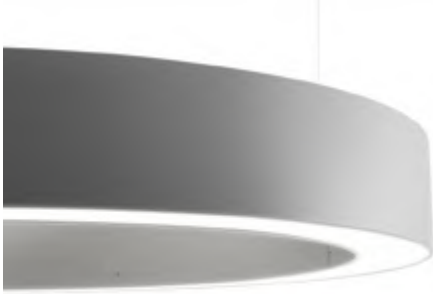

Anello a sospensione in alluminio piegato con schermo superiore e inferiore in policarbonato opalino ad alta trasmittanza. Emissione di luce diretta e indiretta oppure solo diretta, tramite modulo LED. Dimmerazione DALI/ Push DIM di serie su tutte le versioni biemissione. Possibilità di avere LED 4000K su richiesta. Anello rifinito con vernice poliaccrilica color bianco, nero o decorata a mano con foglia oro. Possibilità di personalizzare i colori. Sospensione tramite 3 cavi in acciaio (6 nella versione ø 300cm). Spedizione del prodotto in un pezzo unico. La versione ø 300cm viene spedita in due semicerchi. Ideale per ambienti residenziali, grandi composizioni per uffici, strutture ricettive e spazi pubblici.

Suspension ring in curved aluminium with top and bottom high-transmittance screens in opal polycarbonate. Emission of both direct and indirect light or direct only, through LED modules. All double emission versions provided with DALI/Push DIM dimming. Possibility of having LED 4000K upon request. Ring eventually finished in polyacrylic white paint or black hand-decorated with golden leaf. Possibility to customize the colors. Suspended by means of 3 steel cables (6 in the ø 300cm version). Delivery of the product in a single piece. The ø 300cm version is shipped in two semicircles. Ideal for residential spaces, great compositions for offices, hospitality and public spaces.

GOLDEN RING

	CODICE CODE	FONTI LUMINOSE LIGHT SOURCES	kg
	L08101.080.0408 L08102.080.0408 L08121.080.0408	Potenza assorbita apparecchio / Luminaire power consumption 45W Flusso luminoso apparecchio / Luminaire luminous flux 3053lm 3000K Ra>90 220-240V AC ON-OFF IP40 850°	9,61
	L08101.080.0402 L08102.080.0402 L08121.080.0402	Potenza assorbita apparecchio / Luminaire power consumption 87W Flusso luminoso apparecchio / Luminaire luminous flux 3053lm + 3053lm 3000K Ra>90 220-240V AC dimmable (DALI/Push DIM) IP40 850°	10,68
	L08101.120.0402 L08102.120.0402 L08121.120.0402	Potenza assorbita apparecchio / Luminaire power consumption 150W Flusso luminoso apparecchio / Luminaire luminous flux 5233lm + 5233lm 3000K Ra>90 220-240V AC dimmable (DALI/Push DIM) IP40 850°	15,59
	L08101.180.0402 L08102.180.0402 L08121.180.0402	Potenza assorbita apparecchio / Luminaire power consumption 220W Flusso luminoso apparecchio / Luminaire luminous flux 7850lm + 7850lm 3000K Ra>90 220-240V AC dimmable (DALI/Push DIM) IP40 850°	23,05
	M8101-3 M8102-3 M8121-3	Rosone per collegamento elettrico e per raggruppamento di 3 funi in acciaio. Canopy for power supply and to join 3 steel cables.	0,58

RING COLLECTION

Enzo Panzeri 2015

Registered Design

CODICE
CODE

FONTI LUMINOSE
LIGHT SOURCES

kg



L08101.300.0402
L08102.300.0402
L08121.300.0402

Potenza assorbita apparecchio / Luminaire power consumption 370W 41,48
Flusso luminoso apparecchio / Luminaire luminous flux 13083lm + 13083lm
3000K Ra>90 220-240V AC dimmable (DALI/Push DIM)

IP40 850°

Apparecchio fornito in 2 parti da montare
Fixture in 2 parts to compose

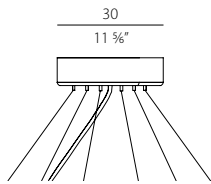
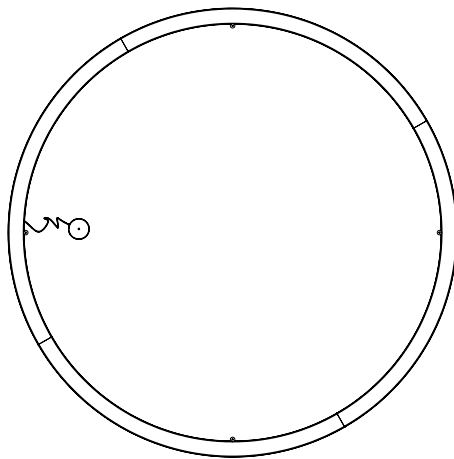
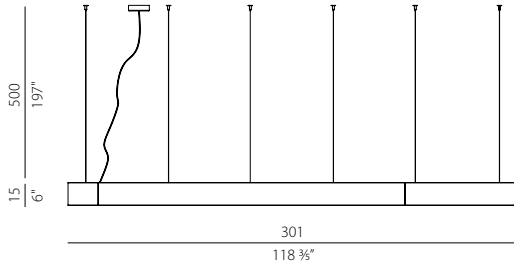

M8101-6
M8102-6
M8121-6

Rosone per collegamento elettrico e per raggruppamento di 6 funi in acciaio. 2,91
Canopy for power supply and to join 6 steel cables.

Fotometrie disponibili www.panzeri.it / Photometric data available at www.panzeri.it

CODICI COLORI DISPONIBILI / COLOUR CODES AVAILABLE

Disponibili a richiesta LED 2700K o 4000K / On request 2700K or 4000K LED available

01 bianco
white **02** nero
black **21** foglia oro
gold leaf







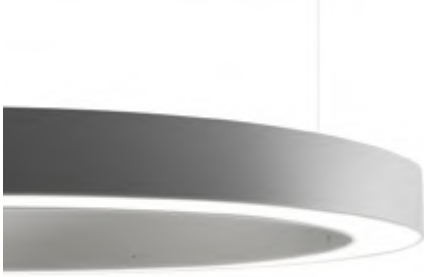

Anello in alluminio con schermo inferiore in policarbonato opale ad alta trasmittanza. Disponibile nelle versioni parete/soffitto e sospensione. Emissione di luce diretta attraverso modulo LED con dimmerazione DALI/Push DIM di serie su tutte le versioni. Anello rifinito con vernice poliaccrilica color bianco, nero, bronzo o decorato a mano con foglia oro. Possibili colori custom su richiesta. Versione a sospensione fornita con 3 cavi in acciaio regolabili in lunghezza (6 cavi per ø 180cm). Versioni a parete/soffitto fornite di kit di montaggio semplificato. Ideale per ambienti residenziali, grandi composizioni per uffici, strutture ricettive e spazi pubblici. Spedizione del prodotto in un pezzo unico già assemblato.

Aluminium ring with bottom high-transmittance screen in opal polycarbonate. Available in wall/ceiling and suspension versions. Emission of direct light provided by LED module with technology DALI/Push DIM on all versions. Ring eventually finished in polyacrilic paint white, black, bronze or hand-decorated in golden leaf. Custom colors are available on request. Suspended version supplied with 3 steel cable adjustable in length (6 cables for ø 180cm). The wall/ceiling version is supplied with a simplified mounting kit. Ideal for residential use, compositions for offices, hospitality facilities and public spaces. Delivery of the product in single piece already assembled.

SILVER RING

	CODICE CODE	FONTI LUMINOSE LIGHT SOURCES	kg
	L08201.050.0402 L08202.050.0402 L08217.050.0402 L08221.050.0402	Potenza assorbita apparecchio / Luminaire power consumption 25W Flusso luminoso apparecchio / Luminaire luminous flux 1809lm 3000K Ra>90 220-240V AC dimmable (DALI/Push DIM) IP40 850°	4,81
	L08201.080.0402 L08202.080.0402 L08217.080.0402 L08221.080.0402	Potenza assorbita apparecchio / Luminaire power consumption 45W Flusso luminoso apparecchio / Luminaire luminous flux 3053lm 3000K Ra>90 220-240V AC dimmable (DALI/Push DIM) IP40 850°	8,74
	L08201.120.0402 L08202.120.0402 L08217.120.0402 L08221.120.0402	Potenza assorbita apparecchio / Luminaire power consumption 75W Flusso luminoso apparecchio / Luminaire luminous flux 5233lm 3000K Ra>90 220-240V AC dimmable (DALI/Push DIM) IP40 850°	13,42
	L08201.180.0402 L08202.180.0402 L08217.180.0402 L08221.180.0402	Potenza assorbita apparecchio / Luminaire power consumption 110W Flusso luminoso apparecchio / Luminaire luminous flux 7850lm 3000K Ra>90 220-240V AC dimmable (DALI/Push DIM) IP40 850°	21,31

RING COLLECTION

Enzo Panzeri 2016

	CODICE CODE	FONTE LUMINOSE LIGHT SOURCES	kg
	P08201.050.0402 P08202.050.0402 P08217.050.0402 P08221.050.0402	Potenza assorbita apparecchio / Luminaire power consumption 25W Flusso luminoso apparecchio / Luminaire luminous flux 1809lm 3000K Ra>90 220-240V AC dimmable (DALI/Push DIM) LED IP40 850°	4,90
	P08201.080.0402 P08202.080.0402 P08217.080.0402 P08221.080.0402	Potenza assorbita apparecchio / Luminaire power consumption 45W Flusso luminoso apparecchio / Luminaire luminous flux 3053lm 3000K Ra>90 220-240V AC dimmable (DALI/Push DIM) LED IP40 850°	7,63
	P08201.120.0402 P08202.120.0402 P08217.120.0402 P08221.120.0402	Potenza assorbita apparecchio / Luminaire power consumption 75W Flusso luminoso apparecchio / Luminaire luminous flux 5233lm 3000K Ra>90 220-240V AC dimmable (DALI/Push DIM) LED IP40 850°	11,63
	P08201.180.0402 P08202.180.0402 P08217.180.0402 P08221.180.0402	Potenza assorbita apparecchio / Luminaire power consumption 110W Flusso luminoso apparecchio / Luminaire luminous flux 7850lm 3000K Ra>90 220-240V AC dimmable (DALI/Push DIM) LED IP40 850°	18,86

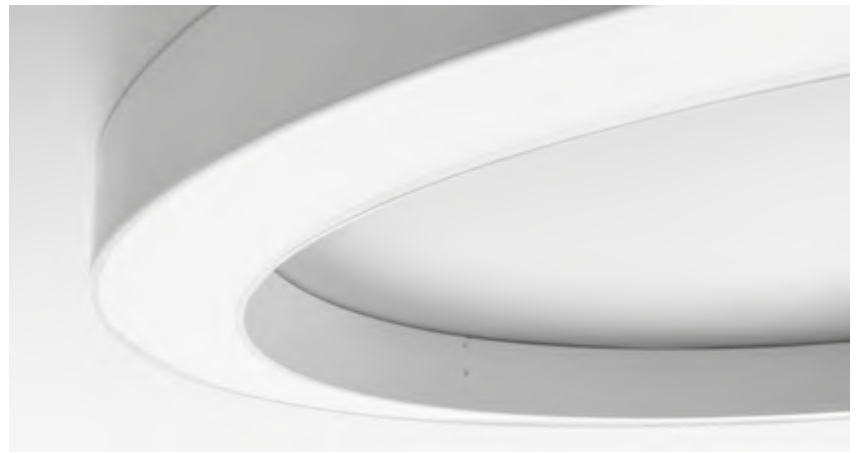

Fotometrie disponibili www.panzeri.it / Photometric data available at www.panzeri.it

CODICI COLORI DISPONIBILI / COLOUR CODES AVAILABLE

Disponibili a richiesta LED 2700K o 4000K / On request 2700K or 4000K LED available

01 bianco white
 02 nero black
 17 bronzo bronze
 21 foglia oro gold leaf





RING COLLECTION

Officina Panzeri 2016



PLANET RING

Lampada nelle versioni sospensione, parete/soffitto e incasso in metallo e schermo diffusore in policarbonato opale. Emissione di luce diretta attraverso modulo LED. Possibilità di avere LED 4000K su richiesta. Tutte le versioni sono disponibili con dimmerazione DALI/ Push DIM o luce d'emergenza. Struttura rifinita con vernice poliacrilica in bianco (disponibili colori custom su richiesta). Schermo diffusore ad alta trasmittanza con fissaggio magnetico e scheda LED ad aggancio rapido per facile accesso alla componentistica elettronica on board. Spedizione del prodotto in un pezzo unico. Ideale per uffici, strutture ricettive o uso residenziale.

Suspension, wall/ceiling and recessed lamp in metal with high transmittance opal polycarbonate diffuser screen. Emission of direct light provided by a LED module. Possibility of having LED 4000K upon request. All versions are also available with DALI/Push DIM dimming or emergency light. Fixture finished in polyacrylic paint in white (custom colors available on request). The diffuser screen is fastened with magnets. LED board with quick connection for easy access to the electronic components on board. Delivery of the product in a single piece. Ideal for offices, hospitality facilities or residential use.

	CODICE CODE	FONTI LUMINOSE LIGHT SOURCES	kg
	P08301.040.0401	Potenza assorbita apparecchio / Luminaire power consumption 28W Flusso luminoso apparecchio / Luminaire luminous flux 2199lm 3000K Ra>90 220-240V AC ON-OFF IP40 850°	3,85
	P08301.040.0402	Potenza assorbita apparecchio / Luminaire power consumption 28W Flusso luminoso apparecchio / Luminaire luminous flux 2199lm 3000K Ra>90 220-240V AC dimmable (DALI/Push DIM) IP40 850°	3,85
	P08301.040.0407	Potenza assorbita apparecchio / Luminaire power consumption 28W Flusso luminoso apparecchio / Luminaire luminous flux 2199lm 3000K Ra>90 220-240V AC emergency IP40 850° Emergenza 1h/12h Emergency 1h/12h	3,85
	P08301.070.0401	Potenza assorbita apparecchio / Luminaire power consumption 71W Flusso luminoso apparecchio / Luminaire luminous flux 5864lm 3000K Ra>90 220-240V AC ON-OFF IP40 850°	8,60
	P08301.070.0402	Potenza assorbita apparecchio / Luminaire power consumption 71W Flusso luminoso apparecchio / Luminaire luminous flux 5864lm 3000K Ra>90 220-240V AC dimmable (DALI/Push DIM) IP40 850°	8,60
	P08301.070.0407	Potenza assorbita apparecchio / Luminaire power consumption 71W Flusso luminoso apparecchio / Luminaire luminous flux 5864lm 3000K Ra>90 220-240V AC emergency IP40 850° Emergenza 1h/12h Emergency 1h/12h	8,60
	P08301.100.0401	Potenza assorbita apparecchio / Luminaire power consumption 142W Flusso luminoso apparecchio / Luminaire luminous flux 11727lm 3000K Ra>90 220-240V AC ON-OFF IP40 850°	13,64
	P08301.100.0402	Potenza assorbita apparecchio / Luminaire power consumption 142W Flusso luminoso apparecchio / Luminaire luminous flux 11727lm 3000K Ra>90 220-240V AC dimmable (DALI/Push DIM) IP40 850°	13,64
	P08301.100.0407	Potenza assorbita apparecchio / Luminaire power consumption 142W Flusso luminoso apparecchio / Luminaire luminous flux 11727lm 3000K Ra>90 220-240V AC emergency IP40 850° Emergenza 1h/12h Emergency 1h/12h	13,64

RING COLLECTION

Officina Panzeri 2016

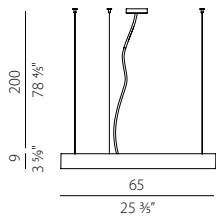

CODICE CODE	FONTI LUMINOSE LIGHT SOURCES	kg
L08301.070.0401	Potenza assorbita apparecchio / Luminaire power consumption 71W Flusso luminoso apparecchio / Luminaire luminous flux 5864lm 3000K Ra>90 220-240V AC ON-OFF IP40 850°	9,83
L08301.070.0402	Potenza assorbita apparecchio / Luminaire power consumption 71W Flusso luminoso apparecchio / Luminaire luminous flux 5864lm 3000K Ra>90 220-240V AC dimmable (DALI/Push DIM) IP40 850°	9,83
L08301.070.0407	Potenza assorbita apparecchio / Luminaire power consumption 71W Flusso luminoso apparecchio / Luminaire luminous flux 5864lm 3000K Ra>90 220-240V AC emergency IP40 850° Emergenza 1h/12h / Emergency 1h/12h	9,83

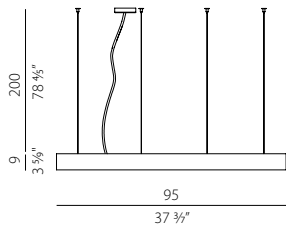

L08301.100.0401	Potenza assorbita apparecchio / Luminaire power consumption 142W Flusso luminoso apparecchio / Luminaire luminous flux 11727lm 3000K Ra>90 220-240V AC ON-OFF IP40 850°	13,31
L08301.100.0402	Potenza assorbita apparecchio / Luminaire power consumption 142W Flusso luminoso apparecchio / Luminaire luminous flux 11727lm 3000K Ra>90 220-240V AC dimmable (DALI/Push DIM) IP40 850°	13,31
L08301.100.0407	Potenza assorbita apparecchio / Luminaire power consumption 142W Flusso luminoso apparecchio / Luminaire luminous flux 11727lm 3000K Ra>90 220-240V AC emergency IP40 850° Emergenza 1h/12h / Emergency 1h/12h	13,31

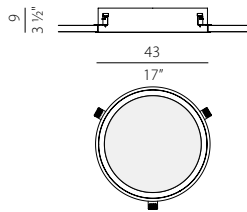

X08301.040.0401	Potenza assorbita apparecchio / Luminaire power consumption 28W Flusso luminoso apparecchio / Luminaire luminous flux 2199lm 3000K Ra>90 220-240V AC ON-OFF IP40 IP20 850°	4,12
X08301.040.0402	Potenza assorbita apparecchio / Luminaire power consumption 28W Flusso luminoso apparecchio / Luminaire luminous flux 2199lm 3000K Ra>90 220-240V AC dimmable (DALI/Push DIM) IP40 IP20 850°	4,12
X08301.040.0407	Potenza assorbita apparecchio / Luminaire power consumption 28W Flusso luminoso apparecchio / Luminaire luminous flux 2199lm 3000K Ra>90 220-240V AC emergency IP40 IP20 850° Emergenza 1h/12h / Emergency 1h/12h	4,12

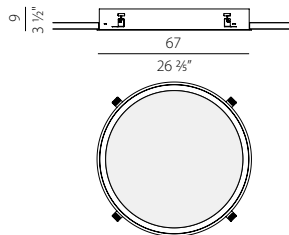

X08301.070.0401	Potenza assorbita apparecchio / Luminaire power consumption 71W Flusso luminoso apparecchio / Luminaire luminous flux 5864lm 3000K Ra>90 220-240V AC ON-OFF IP40 IP20 850°	8,83
X08301.070.0402	Potenza assorbita apparecchio / Luminaire power consumption 71W Flusso luminoso apparecchio / Luminaire luminous flux 5864lm 3000K Ra>90 220-240V AC dimmable (DALI/Push DIM) IP40 IP20 850°	8,83
X08301.070.0407	Potenza assorbita apparecchio / Luminaire power consumption 71W Flusso luminoso apparecchio / Luminaire luminous flux 5864lm 3000K Ra>90 220-240V AC emergency IP40 IP20 850° Emergenza 1h/12h / Emergency 1h/12h	8,83



Fotometrie disponibili www.panzeri.it / Photometric data available at www.panzeri.it

CODICI COLORI DISPONIBILI / COLOUR CODES AVAILABLE

Disponibili a richiesta LED TUNABLE WHITE o 4000K / On request TUNABLE WHITE or 4000K LED available

01 bianco
white







Lampada a sospensione in alluminio tornito. Emissione indiretta attraverso COB LED con dimmerazione DALI/ Push DIM integrata. Disco rifinito con vernice poliacrilica color bianco, nero e decorata a mano con foglia oro. Possibili colori custom su richiesta. Ideale per hall, zone living, grandi spazi.

Suspension lamp in turned aluminium. Emission of indirect light provided by LED COB with integrated technology DALI/Push DIM. Fixture finished in polyacrylic paint white, black and hand-decorated in golden leaf. Custom colors are available on request. Ideal for halls, living, and public spaces.

CODICE CODE	FONTI LUMINOSE LIGHT SOURCES	kg
-------------	------------------------------	----



L09301.060.0402
L09302.060.0402
L09321.060.0402

Potenza assorbita apparecchio / Luminaire power consumption 43W
 Flusso luminoso apparecchio / Luminaire luminous flux 4413lm
 3000K Ra>90 220-240V AC dimmable (DALI/Push DIM)

3,46

IP20

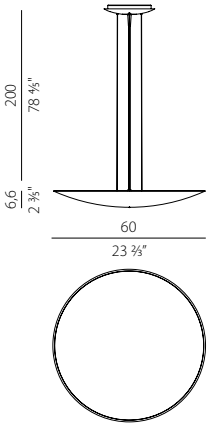

L09301.100.0402
L09302.100.0402
L09321.100.0402

Potenza assorbita apparecchio / Luminaire power consumption 88W
 Flusso luminoso apparecchio / Luminaire luminous flux 8825lm
 3000K Ra>90 220-240V AC dimmable (DALI/Push DIM)

7,35

IP20

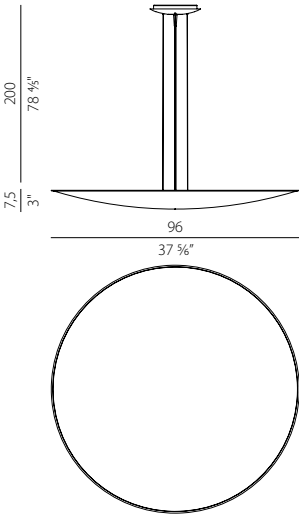

Fotometrie disponibili www.panzeri.it / Photometric data available at www.panzeri.it

CODICI COLORI DISPONIBILI / COLOUR CODES AVAILABLE

01 bianco
white

02 nero
black

21 foglia oro
gold leaf

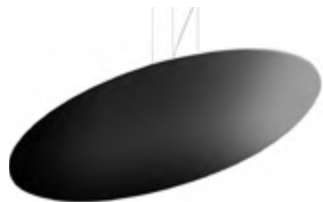





La gamma di lampade da parete della serie GONIO risponde ai più elevati standard di comfort visivo per l'illuminazione di ambienti di passaggio o di accoglienza quali corridoi, anticamere, hall di alberghi e uffici. Geometrie calibrate ne fanno un prodotto dalle forme essenziali ottimizzate per una perfetta distribuzione dei fasci luminosi verso l'alto e verso il basso, ottenuta grazie all'uso di lenti professionali con angolazioni studiate per evitare qualsiasi tipo di abbagliamento. Il corpo è realizzato in alluminio estruso con terminali di chiusura in pressofusione di alluminio, disponibile nelle finiture bianco, nero, bronzo, ottone satinato e titanio. È proposto in due versioni di lunghezze differenti per maggiori possibilità applicative, completo di driver dimmerabile integrato per regolazione dell'intensità luminosa tramite dispositivi DALI o Push DIM.

GONIO is a range of wall mount sconces that respond to the most elevated standards of visual comfort for the illumination of pathways or hospitality areas, such as corridors, waiting rooms, halls and offices. Precise geometries and essential lines make GONIO a product optimized for a better distribution of light upwards and downwards, thanks to the use of professional lenses with angle degrees engineered to avoid any kind of glaring. The body of the lamp is built in extruded aluminum with end caps in aluminum die-cast, available in white, black, bronze, mat brass and titanium finishes. It is offered in two versions with different lengths for greater application settings, complete with integrated dimmable driver for regulating the light intensity through DALI or Push DIM devices.

NOVELTY	CODICE CODE	FONTI LUMINOSE LIGHT SOURCES	kg
	A01901.030.0502 A01902.030.0502 A01917.030.0502 A01919.030.0502 A01930.030.0502	Potenza assorbita apparecchio / Luminaire power consumption 26W Flusso luminoso apparecchio / Luminaire luminous flux 2168lm 2700K Ra>90 220-240V AC dimmable (DALI/Push DIM) IP40	1,08
	A01901.030.0402 A01902.030.0402 A01917.030.0402 A01919.030.0402 A01930.030.0402	Potenza assorbita apparecchio / Luminaire power consumption 26W Flusso luminoso apparecchio / Luminaire luminous flux 2252lm 3000K Ra>90 220-240V AC dimmable (DALI/Push DIM) IP40	1,08
	A01901.060.0502 A01902.060.0502 A01917.060.0502 A01919.060.0502 A01930.060.0502	Potenza assorbita apparecchio / Luminaire power consumption 50W Flusso luminoso apparecchio / Luminaire luminous flux 4337lm 2700K Ra>90 220-240V AC dimmable (DALI/Push DIM) IP40	2,05
	A01901.060.0402 A01902.060.0402 A01917.060.0402 A01919.060.0402 A01930.060.0402	Potenza assorbita apparecchio / Luminaire power consumption 50W Flusso luminoso apparecchio / Luminaire luminous flux 4503lm 3000K Ra>90 220-240V AC dimmable (DALI/Push DIM) IP40	2,05

Fotometrie disponibili www.panzeri.it / Photometric data available at www.panzeri.it

CODICI COLORI DISPONIBILI / COLOUR CODES AVAILABLE

- 01** bianco
white
- 02** nero
black
- 17** bronzo
bronze
- 19** ottone satinato
mat brass
- 30** titanio
titanium

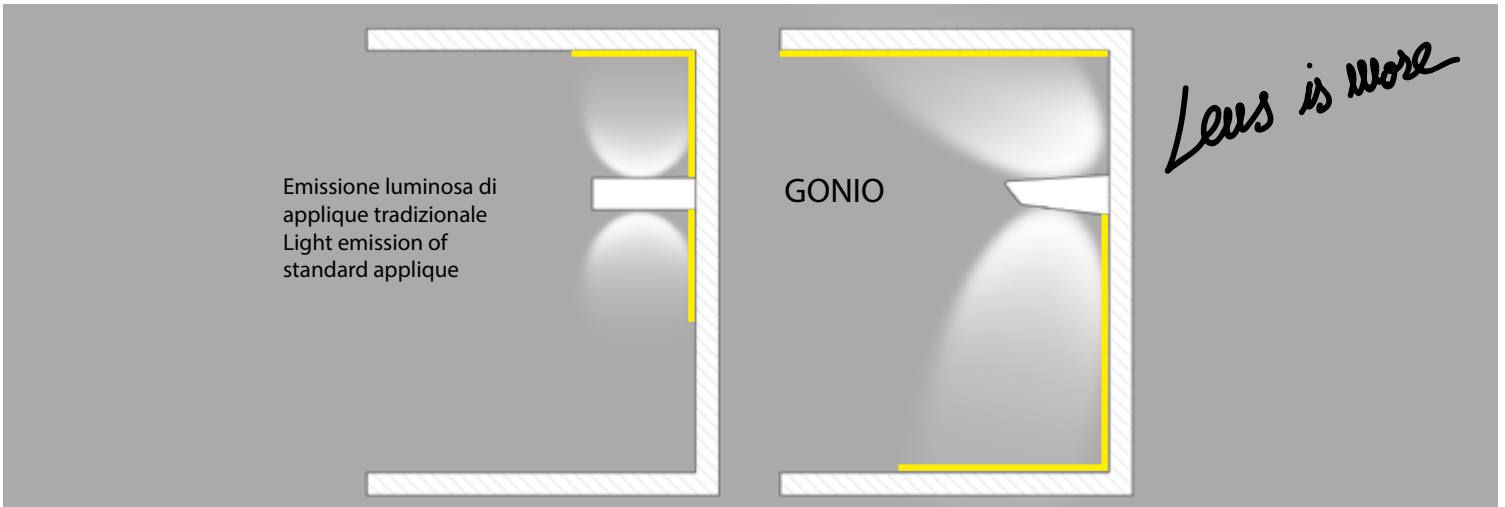

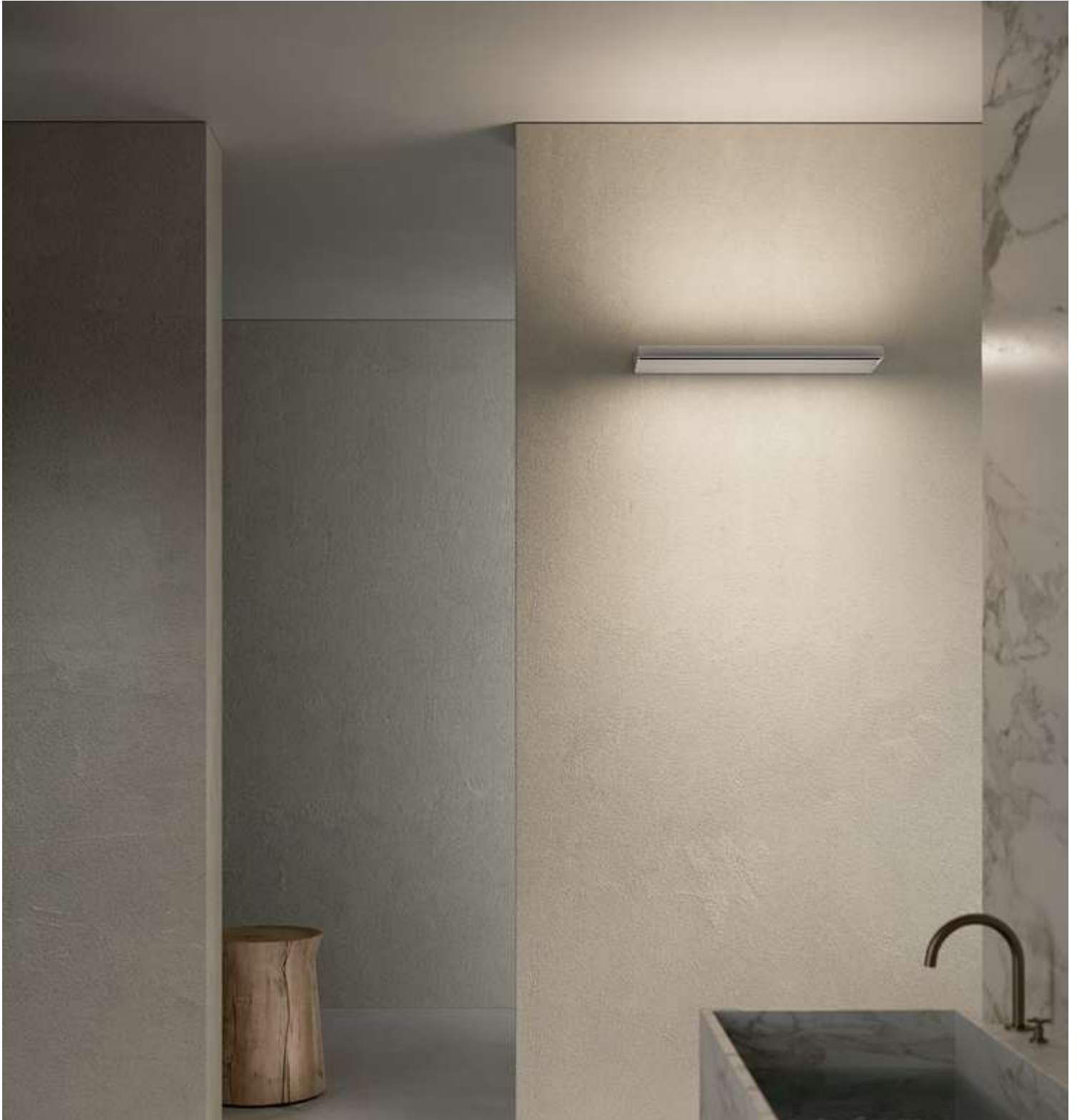



Un corpo illuminante costituito dalla combinazione di elementi lineari trasversali e longitudinali, in grado di caratterizzare con le sue infinite possibilità compositive la scenografia di ogni ambiente. Le numerose varianti consentono un'installazione libera e intuitiva sia a sospensione che a soffitto o parete. La doppia emissione costituisce un ulteriore fattore di versatilità: nella versione a sospensione infatti è possibile invertire l'orientamento delle funi, permettendo l'installazione del prodotto su entrambe le facce per una maggiore illuminazione diretta o indiretta. I modelli a sospensione sono inoltre abbinabili agli articoli To-Be 22, per uno sviluppo tridimensionale delle composizioni. Disponibile nelle finiture bianco, nero satinato, bronzo, ottone satinato e titanio, con diffusori opalini o neri.

A lighting fitting made of a combination of linear longitudinal elements, enabling to characterize every interior space with its endless configuration possibilities. The many variants allow a free and intuitive installation, suspended or surface mounted on ceiling or wall. The double emission provides an additional versatility factor: the suspended version allows to invert the hanging steel cables, enabling the installation of the product on both sides for an illumination with majority of light downwards or upwards. Furthermore, the suspension models can be combined with To-Be 22, for a tridimensional construction of the product layout. Available in finishes white, satin black, bronze, mat brass, titanium, with white opal diffuser or black diffuser.

CODICE CODE	FONTI LUMINOSE LIGHT SOURCES	kg
-------------	------------------------------	----



L02801.115.0502
L02806.115.0502
L02817.115.0502
L02819.115.0502
L02830.115.0502

Potenza assorbita apparecchio / Luminaire power consumption 80W
 Flusso luminoso apparecchio / Luminaire luminous flux 5045lm
 2700K Ra>90 220-240V AC dimmable (DALI/Push DIM)

2,80

LED IP20Diffusori opali
Opal diffusers

L02901.115.0502
L02906.115.0502
L02917.115.0502
L02919.115.0502
L02930.115.0502

Potenza assorbita apparecchio / Luminaire power consumption 80W
 Flusso luminoso apparecchio / Luminaire luminous flux 2118lm
 2700K Ra>90 220-240V AC dimmable (DALI/Push DIM)

2,80

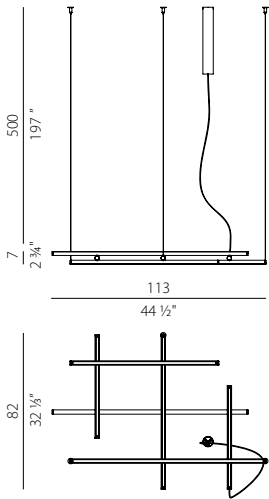
LED IP20Diffusori neri
Black diffusers

ORIENTAMENTI D'INSTALLAZIONE / INSTALLATION LAYOUTS

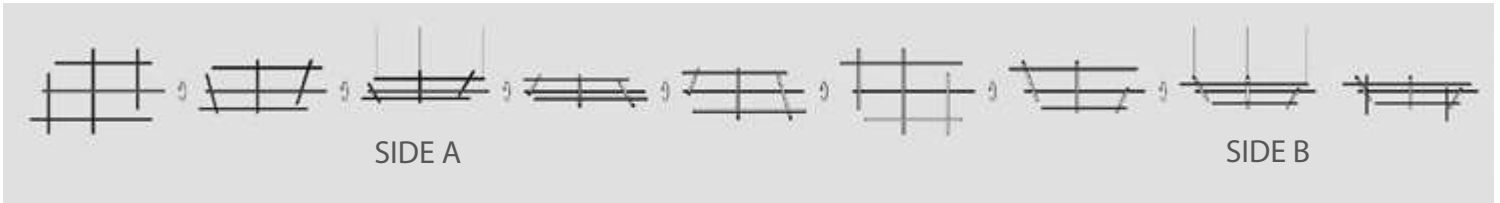

ESEMPI D'INSTALLAZIONE / INSTALLATION EXAMPLES

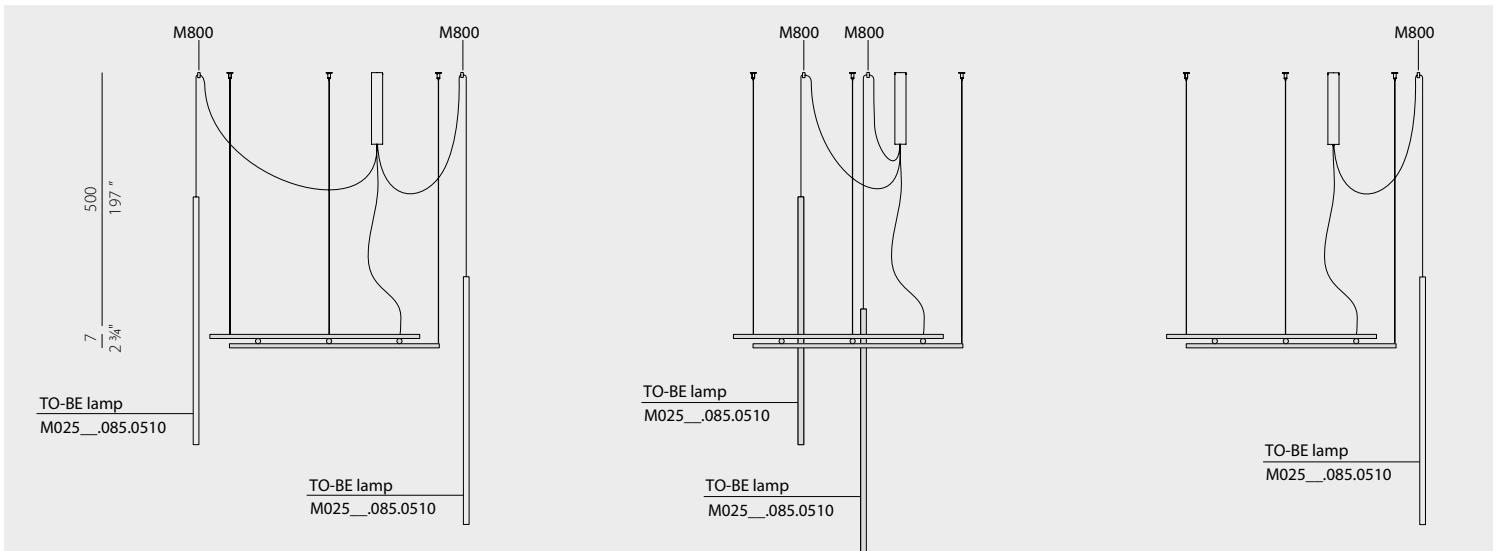

Composizioni con max n.2 TO-BE M025 / Configuration with n.2 TO-BE M025 max.

TO-BE M025 e decentramenti M800 vanno ordinati separatamente / TO-BE M025 and M800 offsets to be ordered separately

HILOW

Matteo Thun 2020

Registered Design

	CODICE CODE	FONTI LUMINOSE LIGHT SOURCES	kg
	P02801.115.0502 P02806.115.0502 P02817.115.0502 P02819.115.0502 P02830.115.0502	Potenza assorbita apparecchio / Luminaire power consumption 78W Flusso luminoso apparecchio / Luminaire luminous flux 4602lm 2700K Ra>90 220-240V AC dimmable (DALI/Push DIM) LED IP20 Diffusori opali Opal diffusers	2,97
	P02901.115.0502 P02906.115.0502 P02917.115.0502 P02919.115.0502 P02930.115.0502	Potenza assorbita apparecchio / Luminaire power consumption 78W Flusso luminoso apparecchio / Luminaire luminous flux 2356lm 2700K Ra>90 220-240V AC dimmable (DALI/Push DIM) LED IP20 Diffusori neri Black diffusers	2,97
	P02801.115.0510 P02806.115.0510 P02817.115.0510 P02819.115.0510 P02830.115.0510	Potenza assorbita apparecchio / Luminaire power consumption 72W Flusso luminoso apparecchio / Luminaire luminous flux 4897lm 2700K Ra>90 24V DC LED IP20 Diffusori opali, driver non incluso Opal diffusers, driver not included	2,15
	P02901.115.0510 P02906.115.0510 P02917.115.0510 P02919.115.0510 P02930.115.0510	Potenza assorbita apparecchio / Luminaire power consumption 72W Flusso luminoso apparecchio / Luminaire luminous flux 2651lm 2700K Ra>90 24V DC LED IP20 Diffusori opali, driver non incluso Opal diffusers, driver not included	2,15
	A02901.115.0502 A02906.115.0502 A02917.115.0502 A02919.115.0502 A02930.115.0502	Potenza assorbita apparecchio / Luminaire power consumption 77W Flusso luminoso apparecchio / Luminaire luminous flux 3812lm 2700K Ra>90 220-240V AC dimmable (DALI/Push DIM) LED IP20 Diffusore frontale nero Black front diffuser	2,97
	A02901.115.0510 A02906.115.0510 A02917.115.0510 A02919.115.0510 A02930.115.0510	Potenza assorbita apparecchio / Luminaire power consumption 71W Flusso luminoso apparecchio / Luminaire luminous flux 4088lm 2700K Ra>90 24V DC LED IP20 Diffusore frontale nero, driver non incluso Black front diffuser, driver not included	2,15

Fotometrie disponibili www.panzeri.it / Photometric data available at www.panzeri.it

CODICI COLORI DISPONIBILI / COLOUR CODES AVAILABLE

01 bianco white	06 nero satinato mat black	17 bronzo bronze	19 ottone satinato mat brass	30 titanio titanium

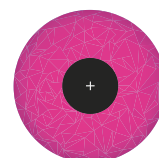

**BIGSEE
PRODUCTDESIGN
AWARD 2021
WINNER**

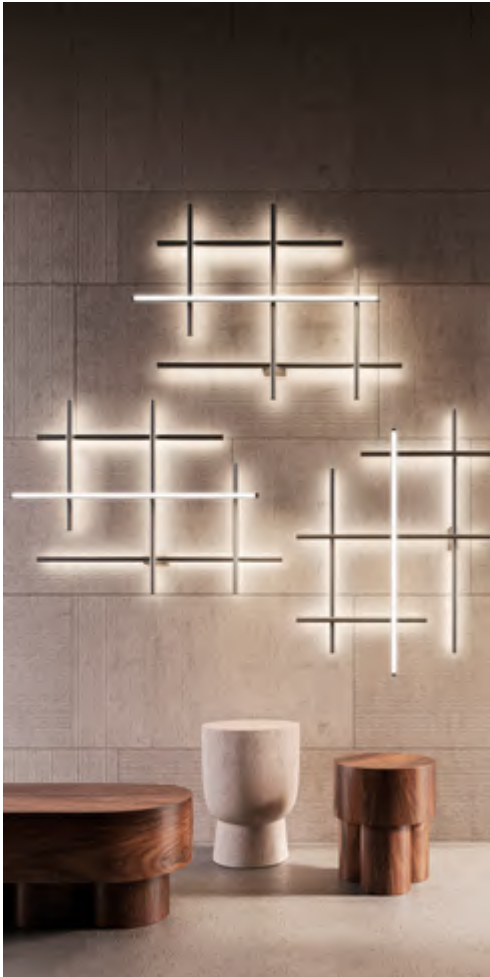





Dall'esperienza di Hilow nasce la serie che rappresenta il principio fondante del sistema nella sua forma più elementare: un modulo lineare sottile e discreto anche nell'emissione di luce; un'asta luminosa applicabile a muro o per installazione libera a pavimento, con struttura in alluminio estruso e schermo rivolto verso la parete per un gradevole effetto di luce indiretta e soffusa. L'intensità di luce può essere ridotta sia nei modelli da parete, che nelle piantane, dotate di cavo con pedale di regolazione. Versioni a parete disponibili in bianco, nero satinato, bronzo, ottone satinato e titanio; nero satinato, bronzo e ottone satinato per quella a pavimento con basamento in marmo nero marquina. Piantana con basamento in travertino in abbinamento alle finiture bronzo, ottone satinato e bianco soft materico; versione in marmo verde alpi fornita in abbinamento alle colorazioni nero, bronzo e ottone satinato.

From the success of Hilow, this new series represents the founding principle of the system in its purest form: a linear module slender and discreet also in the light emission; a luminous stick to install on the wall or free-standing on the floor, with a structure in extruded aluminum and diffuser directed towards the wall for a comfortable indirect light effect. The intensity of light can be dimmed both in the wall mount version and in the floor version, equipped with electrical cable with dimming pedal. Wall-mount versions are available in white, satin black, bronze, mat brass and titanium finishes; satin black, bronze and mat brass for the floor version with base in black marquina marble. Floor version with base in travertine paired with bronze, mat brass an textured soft white finish; "verde alpi" version paired with black, bronze and mat brass finishes.

NOVELTY

CODICE CODE

FONTI LUMINOSE LIGHT SOURCES

kg

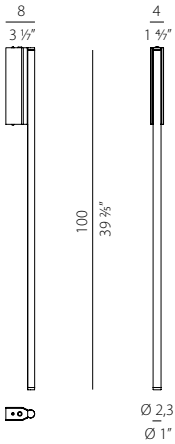

A11001.100.0502
A11006.100.0502
A11017.100.0502
A11019.100.0502
A11030.100.0502

Potenza assorbita apparecchio / Luminaire power consumption 17W
 Flusso luminoso apparecchio / Luminaire luminous flux 1018lm
 2700K Ra>90 220-240V AC dimmable (DALI/Push DIM)
 IP20

1,16

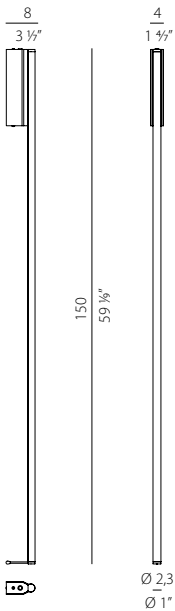

A11001.150.0502
A11006.150.0502
A11017.150.0502
A11019.150.0502
A11030.150.0502

Potenza assorbita apparecchio / Luminaire power consumption 27W
 Flusso luminoso apparecchio / Luminaire luminous flux 1696lm
 2700K Ra>90 220-240V AC dimmable (DALI/Push DIM)
 IP20

1,35

YCI11002.400

Cavo di alimentazione di lunghezza 4m (157,5") con interruttore a pedale e spina.
 4m (157,5") long power cable with foot switch and plug.

Accessorio per Hilow Line A110
 Accessory for Hilow Line A110

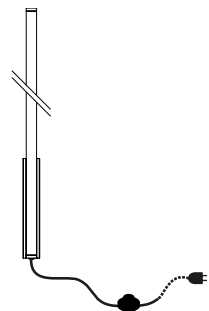

HILOW LINE

Matteo Thun e Benedetto Fasciana 2021

	CODICE CODE	FONTE LUMINOSE LIGHT SOURCES	kg
	T10817.200.0522 T10819.200.0522 T10828.200.0522	Potenza assorbita apparecchio / Luminaire power consumption 39W Flusso luminoso apparecchio / Luminaire luminous flux 2714lm 2700K Ra>90 220-240V AC dimmer on cable IP20	10,16
		Base di appoggio in marmo travertino bianco Bearing base in white travertine marble	
	T10906.200.0522 T10917.200.0522 T10919.200.0522	Potenza assorbita apparecchio / Luminaire power consumption 39W Flusso luminoso apparecchio / Luminaire luminous flux 2714lm 2700K Ra>90 220-240V AC dimmer on cable IP20	10,16
		Base di appoggio in marmo nero marquina Bearing base in black marquina marble	
	T10706.200.0522 T10717.200.0522 T10719.200.0522	Potenza assorbita apparecchio / Luminaire power consumption 39W Flusso luminoso apparecchio / Luminaire luminous flux 2714lm 2700K Ra>90 220-240V AC dimmer on cable IP20	10,16
		Base di appoggio in marmo verde alpi Bearing base in verde alpi marble	

Fotometrie disponibili www.panzeri.it / Photometric data available at www.panzeri.it

CODICI COLORI DISPONIBILI / COLOUR CODES AVAILABLE

01 bianco white
 06 nero satinato mat black
 17 bronzo bronze
 19 ottone satinato mat brass
 28 bianco soft materico textured soft white
 30 titanio titanium
 02 nero black

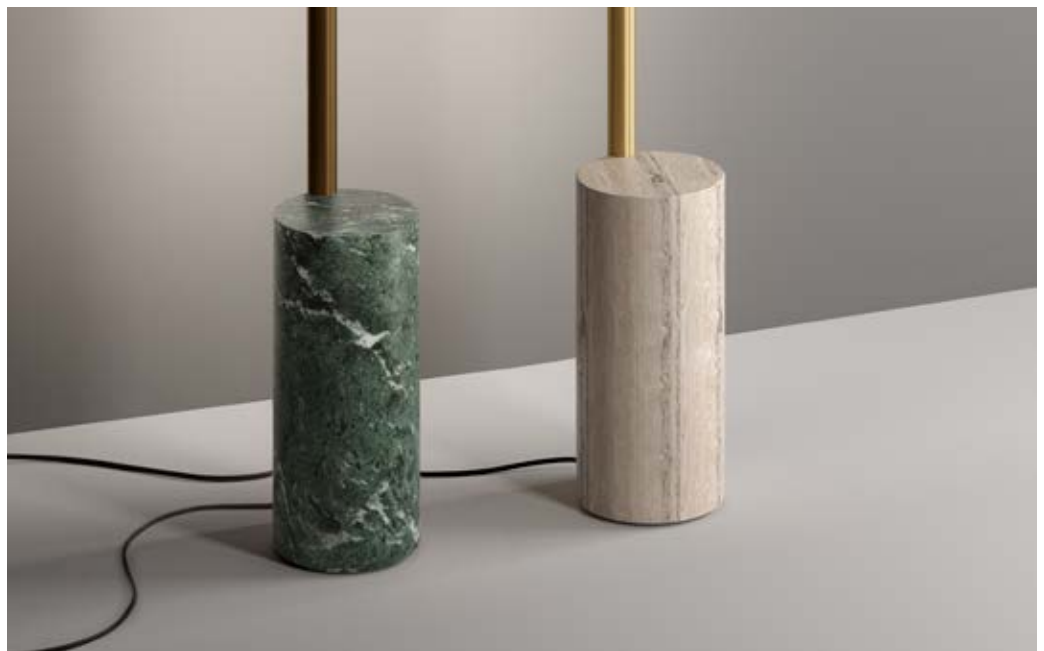



JACKIE

Enzo Panzeri 2015

Registered Design





Lampada da tavolo, terra o parete/soffitto costituita da estruso in alluminio per la struttura e pressofusione di alluminio per la testa e lo snodo. Diffusore in policarbonato con perimetro luminoso e doppia serigrafia appositamente studiata per ottimizzare il fascio luminoso e ridurre l'abbagliamento. Fascio luminoso orientabile ottenuto da 1 modulo LED composto da 18 diodi. Luce dimmerabile con CRI=90 per tutte le versioni (tranne versione P/B) con tecnologia Step DIM a 5 regolazioni di intensità luminosa e luce di cortesia. Struttura rifinita con vernice poliaccrilica in bianco, nero, ottone satinato o spazzolato e verniciato colore titanio. Testa rotante su 2 assi grazie a un doppio snodo. Miniaturizzazione del giunto a snodo con possibilità di regolarne la tenuta. Disponibili accessori nella versione C: morsetto, perno e braccio parete. Ideale per uffici, scrivanie, studi, zone notte.

Table, floor or wall/ceiling lamp made of extruded aluminium for the structure and die-cast aluminium for the head and the junction. Diffuser in polycarbonate with luminous perimeter and double screen serigraphy, specifically designed to optimize the beam and reduce the glare. Swiveling light beam created by 1 LED module consisting of 18 diodes. Dimmable light with CRI=90 for all versions (except for version P/B) with technology Step DIM with 5 intensity of light settings and courtesy light. Structure in white, black or mat brass polyacrylic paint, or brushed and colored titanium. Rotating head on 2-axis through a double joint. Miniaturization of the junction with the possibility of regulating the tightness. Accessories available in the C version: clamp, pin and the wall arm. Ideal for offices, desks, studios, night zones.

CODICE CODE	FONTI LUMINOSE LIGHT SOURCES	kg
-------------	------------------------------	----



-  **C07701.000.0409**
- C07702.000.0409**
- C07719.000.0409**
- C07730.000.0409**

Potenza assorbita apparecchio / Luminaire power consumption 10W
 Flusso luminoso apparecchio / Luminaire luminous flux 706lm
 3000K Ra>90 90° 220-240V AC dimmable (Step DIM)
 **IP40** 

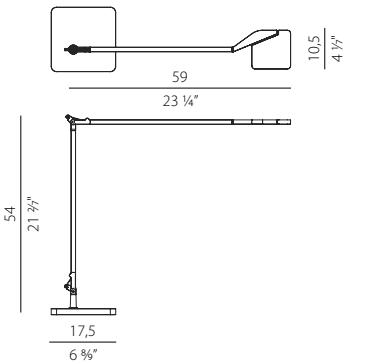
4,10





-  **CM07701.000.0409**
- CM07702.000.0409**
- CM07730.000.0409**

Potenza assorbita apparecchio / Luminaire power consumption 10W
 Flusso luminoso apparecchio / Luminaire luminous flux 706lm
 3000K Ra>90 90° 220-240V AC dimmable (Step DIM)
 **IP40** 

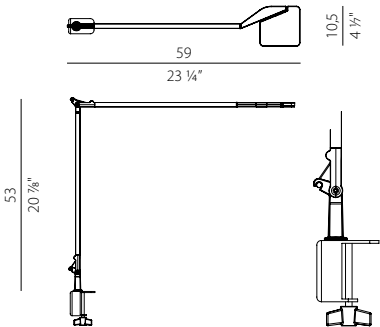
0,83





-  **CP07701.000.0409**
- CP07702.000.0409**
- CP07730.000.0409**

Potenza assorbita apparecchio / Luminaire power consumption 10W
 Flusso luminoso apparecchio / Luminaire luminous flux 706lm
 3000K Ra>90 90° 220-240V AC dimmable (Step DIM)
 **IP40** 

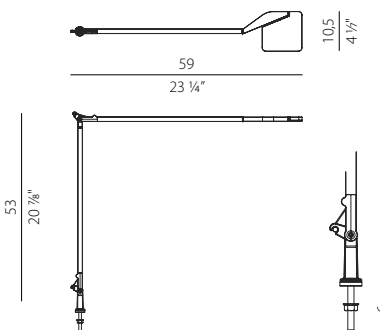
0,63



-  **CA07701.000.0409**
- CA07702.000.0409**
- CA07730.000.0409**

Potenza assorbita apparecchio / Luminaire power consumption 10W
 Flusso luminoso apparecchio / Luminaire luminous flux 706lm
 3000K Ra>90 90° 220-240V AC dimmable (Step DIM)
 **IP40** 

0,84

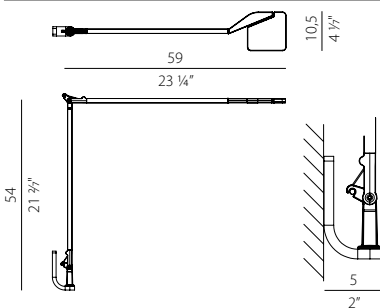

JACKIE

Enzo Panzeri 2015

Registered Design

	CODICE CODE	FONTI LUMINOSE LIGHT SOURCES	kg
	T07701.000.0409	Potenza assorbita apparecchio / Luminaire power consumption 10W	5,21
	T07702.000.0409	Flusso luminoso apparecchio / Luminaire luminous flux 706lm	
	T07730.000.0409	3000K Ra>90 90° 220-240V AC dimmable (Step DIM)	
		IP40	

	A07701.000.0409	Potenza assorbita apparecchio / Luminaire power consumption 10W	0,47
	A07702.000.0409	Flusso luminoso apparecchio / Luminaire luminous flux 706lm	
	A07730.000.0409	3000K Ra>90 90° 220-240V AC dimmable (Step DIM)	
		IP40	

	P07701.000.0101	Potenza assorbita apparecchio / Luminaire power consumption 8,5W	0,46
	P07702.000.0101	Flusso luminoso apparecchio / Luminaire luminous flux 820lm	
	P07730.000.0101	3000K Ra>80 90° 220-240V AC ON-OFF	
		IP40	



Fotometrie disponibili www.panzeri.it / Photometric data available at www.panzeri.it

CODICI COLORI DISPONIBILI / COLOUR CODES AVAILABLE

01 bianco white	02 nero black	19 ottone satinato mat brass	30 titanio titanium
---------------------------	-------------------------	--	-------------------------------









Applique per camere da letto con luce indiretta soffusa e luce da lettura orientabile, in tonalità bianco caldo. È disponibile in due versioni speculari per il posizionamento sul lato sinistro e destro del letto, provvista di una mensola con presa elettrica per la ricarica di piccoli dispositivi USB quali telefoni cellulari. Completa di driver ON-OFF integrati, è fornita con doppio interruttore per accensione separata dell'illuminazione di cortesia e della luce da lettura. I modelli sono disponibili nelle finiture bianco, nero, bronzo, ottone satinato e titanio.

Wall mount fitting for bedrooms with indirect diffused light and adjustable reading light, in warm white. Available in two mirrored version for positioning on left-hand side and right-hand side of the bed, it showcases a shelf with a USB power outlet for charging batteries of electronic devices such as smartphones. Supplied with integrated ON-OFF drivers, it showcases a double switch for separate control of the courtesy light and the reading light. Available in finishes white, black, bronze, mat brass, titanium.

	CODICE CODE	FONTI LUMINOSE LIGHT SOURCES	kg
	A13501.033.0501	Potenza assorbita apparecchio / Luminaire power consumption 18W	1,25
	A13502.033.0501	Flusso luminoso apparecchio / Luminaire luminous flux 392lm + 405lm	
	A13517.033.0501	2700K Ra>90 34° 220-240V AC ON-OFF	
	A13519.033.0501	IP20	
	A13530.033.0501	Versione sinistra Completo di interruttori per doppia accensione e porta USB per ricarica di strumenti elettronici Left version With double switch and USB port for electronic devices charging	
	A13601.033.0501	Potenza assorbita apparecchio / Luminaire power consumption 18W	1,25
	A13602.033.0501	Flusso luminoso apparecchio / Luminaire luminous flux 392lm + 405lm	
	A13617.033.0501	2700K Ra>90 34° 220-240V AC ON-OFF	
	A13619.033.0501	IP20	
	A13630.033.0501	Versione destra Completo di interruttori per doppia accensione e porta USB per ricarica di strumenti elettronici Right version With double switch and USB port for electronic devices charging	

Fotometrie disponibili www.panzeri.it / Photometric data available at www.panzeri.it

CODICI COLORI DISPONIBILI / COLOUR CODES AVAILABLE

- | | | | | |
|---------------------------|-------------------------|----------------------------|--|-------------------------------|
| 01 bianco
white | 02 nero
black | 17 bronzo
bronze | 19 ottone satinato
mat brass | 30 titanio
titanium |
|---------------------------|-------------------------|----------------------------|--|-------------------------------|







Lampade nelle versioni sospensione, tavolo, soffitto/ parete con montatura in metallo rifinita con vernice poliaccrilica in bianco e diffusore in vetro opale satinato soffiato. Emissione di luce diffusa con possibilità di scelta di varie fonti luminose (LED, E27). Vetro fissato da 2 viti laterali con perfetta e omogenea distribuzione della luce al suo interno, senza presenza di zone in ombra. Nella versione a sospensione tiges telescopica. Ideale per ambienti residenziali/commerciali o strutture hospitality.

Suspension, table, ceiling/wall lamps, metal frame in white polyacrylic paint and diffuser in opal blown glass. Diffused light emission provided by a choice of different light sources (LED, E27). Glass fixed by 2 side screws, perfect and homogeneous distribution of the light without any shadow. Telescopic rods in the suspension version. Ideal for residential/commercial environment and for hospitality facilities.

	CODICE CODE	FONTI LUMINOSE LIGHT SOURCES	kg
	L07001_011.0401	Potenza assorbita apparecchio / Luminaire power consumption 9,5W Flusso luminoso apparecchio / Luminaire luminous flux 532lm 3000K Ra>90 220-240V AC ON-OFF IP40	1,76
	L07001_014.0401	Potenza assorbita apparecchio / Luminaire power consumption 13W Flusso luminoso apparecchio / Luminaire luminous flux 758lm 3000K Ra>90 220-240V AC ON-OFF IP40	2,56
	A07001_011.0401	Potenza assorbita apparecchio / Luminaire power consumption 9,5W Flusso luminoso apparecchio / Luminaire luminous flux 532lm 3000K Ra>90 220-240V AC ON-OFF IP40	0,66
	A07001_011.0000	LED retrofit bulb E14 (L max 75mm - Ø max 45mm) max 60W E14 IP40	0,83
	A07001_014.0401	Potenza assorbita apparecchio / Luminaire power consumption 13W Flusso luminoso apparecchio / Luminaire luminous flux 758lm 3000K Ra>90 220-240V AC ON-OFF IP40	1,26
	A07001_014.0000	LED retrofit bulb E27 (L max 100mm - Ø max 55mm) max 70W E27 IP40	1,35
	C07001_011.0401	Potenza assorbita apparecchio / Luminaire power consumption 9,5W Flusso luminoso apparecchio / Luminaire luminous flux 532lm 3000K Ra>90 220-240V AC ON-OFF IP20	0,70
	C07001_014.0401	Potenza assorbita apparecchio / Luminaire power consumption 13W Flusso luminoso apparecchio / Luminaire luminous flux 758lm 3000K Ra>90 220-240V AC ON-OFF IP20	1,48

Fotometrie disponibili www.panzeri.it / Photometric data available at www.panzeri.it

CODICI COLORI DISPONIBILI / COLOUR CODES AVAILABLE

01 bianco
white





Lola è sinonimo di versatilità: un design, molteplici applicazioni, per offrire soluzioni illuminotecniche personalizzate e flessibili, ideali per ogni esigenza progettuale. Si inserisce facilmente in numerosi contesti, dal retail, all'hospitality, al residenziale grazie al suo design caratterizzato da linee compatte, all'elegante forma cilindrica della testa e alla possibilità di orientamento del fascio luminoso. Il modello con base si applica a soffitto o parete, mentre la versione con rosone ad incasso è studiata appositamente per locali con controsoffitti. Le ottiche arretrate e lo snoot di serie consentono di ridurre l'abbagliamento al minimo. Disponibile nelle finiture bianco, nero, bronzo, ottone satinato e titanio. Tutte le versioni sono fornite complete di driver.

Lola is synonym of versatility: one design, multiple applications, to offer personalized and flexible lighting solution, ideal for every interior design need. It can be used in a number of project environments, from retail to hospitality to residential, thanks to its design characterized by compact lines, the elegant cylindrical form of the head and the possibility of adjusting the light direction. The version with the base can be installed on the ceiling or wall, whereas the version with the recessed canopy is engineered specifically for rooms with drywall false ceiling. The recessed lense and the snoot allow to minimize the glaring. Available in finishes white, black, bronze, mat brass and titanium. All versions are provided complete with power supply.

	CODICE CODE	FONTI LUMINOSE LIGHT SOURCES	kg
	P12001.020.2504	Potenza assorbita apparecchio / Luminaire power consumption 9W	0,60
	P12002.020.2504	Flusso luminoso apparecchio / Luminaire luminous flux 972lm	
	P12017.020.2504	3000K Ra>90 30° 220-240V AC dimmable (phase cut)	
	P12019.020.2504	IP20 850°	
	P12030.020.2504		

	X12001.020.4002	Potenza assorbita apparecchio / Luminaire power consumption 18W	0,52
	X12002.020.4002	Flusso luminoso apparecchio / Luminaire luminous flux 1995lm	
	X12017.020.4002	3000K Ra>85 30° 500mA DC dimmable (DALI/Push DIM)	
	X12019.020.4002	IP20 850°	
	X12030.020.4002	Fornito completo di driver DALI/Push DIM Supplied with DALI/Push DIM driver	

Fotometrie disponibili www.panzeri.it / Photometric data available at www.panzeri.it

UGR<12 in funzione delle condizioni di installazione / UGR<12 depending on installation conditions

CODICI COLORI DISPONIBILI / COLOUR CODES AVAILABLE

Disponibili a richiesta LED 2700K / On request 2700K LED available

01 bianco white **02** nero black **17** bronzo bronze **19** ottone satinato mat brass **30** titanio titanium







La tradizione nella lavorazione a mano del vetro soffiato dà vita alla famiglia Murané, una serie di corpi illuminanti installabili a sospensione sia come elementi singoli che secondo composizioni personalizzate, oppure applicabili a soffitto e parete, in appoggio o parzialmente incassati. Il diffusore sferico in vetro color bronzo trasparente è lavorato internamente, con un effetto ondolato di grande impatto decorativo. La sorgente LED di piccole dimensioni è mascherata da un'apposita copertura in silicone, che contribuisce a una diffusione ottimale del fascio luminoso. Le versioni a sospensione sono disponibili con rosone oppure per l'abbinamento con rosone per sospensioni multiple o a scomparsa.

The tradition in the hand-made craftsmanship of blown glass gives birth to Murané, a series of fittings to install as individual suspensions or customized clusters, on surface or as partially recessed wall-ceiling mount fitting. The spherical diffuser in transparent bronze glass is hand-crafted with a wavy effect of great decorative effect. The LED source is minimal and hidden in a silicone cover, that ensures an optimal light diffusion. The suspension versions are available with individual canopy or without, in order to be combined with recessed or cluster canopies.

NOVELTY	CODICE CODE	FONTI LUMINOSE LIGHT SOURCES	kg
	L11505.010.0501 L11506.010.0501	Potenza assorbita apparecchio / Luminaire power consumption 4W Flusso luminoso apparecchio / Luminaire luminous flux approx 167lm 2700K Ra>90 220-240V AC ON-OFF IP20	0,78
	M11505.010.0510	Potenza assorbita apparecchio / Luminaire power consumption 2,7W Flusso luminoso apparecchio / Luminaire luminous flux approx 167lm 2700K Ra>90 24V DC IP20 Fornito senza rosone e driver, per composizioni multiple Supplied without canopy and driver, for multiple configurations	0,53
	P11505.010.0501	Potenza assorbita apparecchio / Luminaire power consumption 4W Flusso luminoso apparecchio / Luminaire luminous flux approx 167lm 2700K Ra>90 24V DC ON-OFF IP20 Fornito completo di driver ON-OFF Supplied with ON-OFF driver	0,52
	X11505.010.0501	Potenza assorbita apparecchio / Luminaire power consumption 4W Flusso luminoso apparecchio / Luminaire luminous flux approx 167lm 2700K Ra>90 24V DC ON-OFF IP20 Fornito completo di driver ON-OFF Supplied with ON-OFF driver	0,42

Fotometrie disponibili www.panzeri.it / Photometric data available at www.panzeri.it

CODICI COLORI DISPONIBILI / COLOUR CODES AVAILABLE

05 champagne
champagne

06 nero satinato
mat black





Estensione della famiglia Murané articolata in composizioni di sfere luminose disposte a corona. Gli anelli sono proposti in due formati, con diametro esterno 80cm o 110cm, e possono a loro volta essere combinati per creare delle sovrapposizioni verticali di più elementi. Struttura portante in alluminio estruso disponibile nelle finiture champagne e nero satinato. Corona di diffusori sferici in vetro soffiato color bronzo trasparente. Accessori di alimentazione e fissaggio da ordinare separatamente, che comprendono rosone, cavo di alimentazione e funi con dispositivi di ancoraggio al soffitto. Per la sovrapposizione di più elementi è obbligatorio ordinare l'apposito accessorio di alimentazione e fissaggio aggiuntivo. Possibilità di realizzare composizioni custom con un numero maggiore di anelli.

Extension of the series Murané made of circular compositions of luminous spheres. The rings are available in two dimensions, with external diameter 80cm or 110cm, and they allow to create vertical configurations of multiple suspensions. The ring is made of extruded aluminum in champagne or satin black finishing. Spherical diffusers in transparent bronze blown glass. Accessories for power supply and hanging to be ordered separately, and include canopy, power cable, steel ropes with devices for ceiling fixing. For laying out more elements it is mandatory to order the additional accessory including power cable and steel ropes. Possibility to realize custom compositions with an increased number of rings.

	CODICE CODE	FONTI LUMINOSE LIGHT SOURCES	kg
	M11605.080.0510	Potenza assorbita apparecchio / Luminaire power consumption 45W Flusso luminoso apparecchio / Luminaire luminous flux 3000lm (18 x 167lm) 2700K Ra>90 24V DC IP20	8,19
	M11606.080.0510		

	M11605.110.0510	Potenza assorbita apparecchio / Luminaire power consumption 62W Flusso luminoso apparecchio / Luminaire luminous flux 4175lm (25 x 167lm) 2700K Ra>90 24V DC IP20	10,30
	M11606.110.0510		

	YFR11605.075.A02	Kit di alimentazione e sospensione con rosone champagne o nero satinato, alimentatore 75W dimmerabile DALI/Push DIM, cavo di alimentazione di lunghezza 5m (196,9"), dispositivi di regolazione rapida e funi in acciaio di lunghezza 5m (196,9"). Rosone per collegamento elettrico di 1 modello M116__080.0410 o 1 modello M116__110.0410. Power supply and suspension kit with champagne or mat black canopy, 75W DALI/Push DIM dimmable driver, 5m (196,9") long power cable, griplocks and 5m (196,9") long steel cables. Canopy for power supply up to 1 M116__080.0410 or 1 M116__110.0410 model.	1,76
	YFR11606.075.A02		

	YFR11605.180.A02	Kit di alimentazione e sospensione con rosone champagne o nero satinato, alimentatore 180W dimmerabile DALI/Push DIM, cavo di alimentazione di lunghezza 5m (196,9"), dispositivi di regolazione rapida e funi in acciaio di lunghezza 5m (196,9"). Rosone per collegamento elettrico di massimo 3 modelli M116__080.0410 o 2 modelli M116__110.0410. Power supply and suspension kit with champagne or mat black canopy, 180W DALI/Push DIM dimmable driver, 5m (196,9") long power cable, griplocks and 5m (196,9") long steel cables. Canopy for power supply up to 3 M116__080.0410 or 2 M116__110.0410 models maximum.	4,74
	YFR11606.180.A02		

MURANE'

Matteo Thun e Benedetto Fasciana 2022

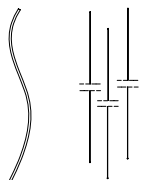
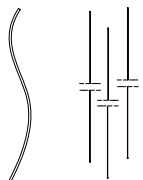
	CODICE CODE	FONTI LUMINOSE LIGHT SOURCES	kg
	YFA11600.010	Kit di alimentazione e sospensione per installazioni multiple con cavo di alimentazione di lunghezza 20cm (7,9") e funi in acciaio di lunghezza 8cm (3,1"). Multiple power supply and suspension kit with 20cm (7,9") long power cable and 8cm (3,1") long steel cables.	0,01
	YFA11600.025	Kit di alimentazione e sospensione per installazioni multiple con cavo di alimentazione di lunghezza 30cm (11,8") e funi in acciaio di lunghezza 27cm (10,6"). Multiple power supply and suspension kit with 30cm (11,8") long power cable and 27cm (10,6") long steel cables.	0,02

Fotometrie disponibili www.panzeri.it / Photometric data available at www.panzeri.it

CODICI COLORI DISPONIBILI / COLOUR CODES AVAILABLE

05 champagne
champagne

06 nero satinato
mat black







COMPOSIZIONI MURANE'R - MURANE'R CONFIGURATIONS

COMPOSIZIONI CONFIGURATIONS	KIT ALIMENTAZIONE E SOSPENSIONE	KIT ALIMENTAZIONE E SOSPENSIONE	KIT SOSPENSIONE PER DIMENSIONI UGUALI	KIT SOSPENSIONE PER DIMENSIONI DIFFERENTI
	FEEDING AND SUSPENSION KIT	FEEDING AND SUSPENSION KIT	SUSPENSION KIT FOR SAME DIMENSIONS	SUSPENSION KIT FOR DIFFERENT DIMENSIONS
	YFR116_.075.A02	YFR116_.180.A02	YFA11600.010	YFA11600.025

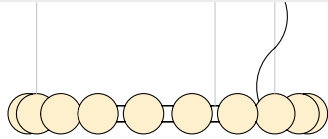

Nr. 1 M116_.080.0410

Nr. 1

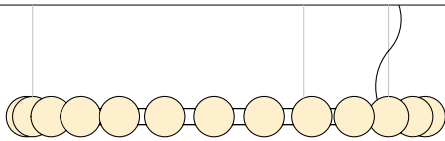

Nr. 1 M116_.110.0410

Nr. 1

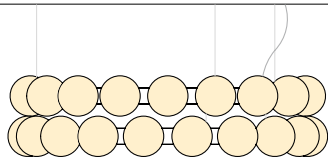

Nr. 2 M116_.080.0410

Nr. 1

Nr. 1

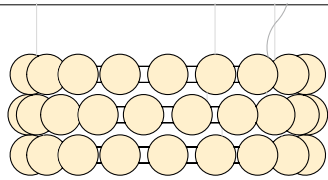

Nr. 3 M116_.080.0410

Nr. 1

Nr. 2

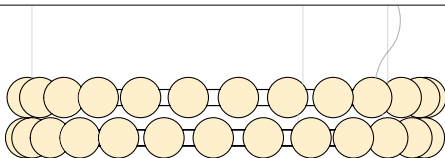

Nr. 2 M116_.110.0410

Nr. 1

Nr. 1

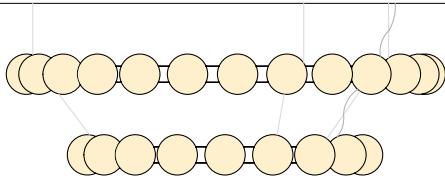

Nr. 1 M116_.110.0410
Nr. 1 M116_.080.0410

Nr. 1

Nr. 1

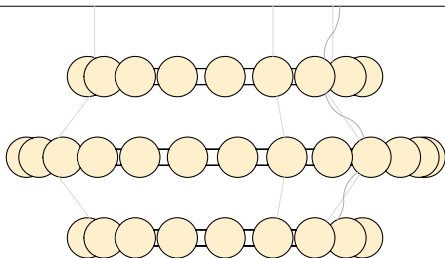

Nr. 1 M116_.110.0410
Nr. 2 M116_.080.0410

Nr. 1

Nr. 2





OLIVIA, EMMA E CLIO

Silvia Poma 2017

Registered Design



Lampada a sospensione in vetro soffiato con particolare finitura a coste dal gusto retrò. Rosone in metallo rifinito con vernice poliaccrilica in color nero o ottone satinato. Emissione di luce diffusa con attacco E27 e lampadina LED con filamenti a vista inclusa. Vetro soffiato disponibile in 7 colorazioni: cristallo, acciaio, ambra, bronzo, tabacco, verde e bianco lucido. Cavi elettrici in tessuto nero con possibilità di personalizzarne la lunghezza. Rosone a 8 uscite (+1 centrale). Ideale per strutture hospitality o zone living residenziali.

Suspension lamp with shaded blown glass with a retro style. Ceiling metal canopy in black polyacrylic paint and in mat brass. Diffused light in LED bulb E27 distinguished by visible filaments. Seven colors glass available: crystal, steel, amber, bronze, tobacco, green and glossy white. Black fabric electrical cables and possibility to customize the length. Canopy with 8 outputs (+1 in the center). Ideal for hospitality or residential facilities.

CODICE CODE	FONTI LUMINOSE LIGHT SOURCES	kg
-------------	------------------------------	----

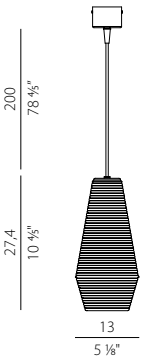

- L09751.000.0200**
- L09752.000.0200**
- L09753.000.0200**
- L09754.000.0200**
- L09755.000.0200**
- L09756.000.0200**
- L09757.000.0200**
- L09771.000.0200**
- L09772.000.0200**
- L09773.000.0200**
- L09774.000.0200**
- L09775.000.0200**
- L09776.000.0200**
- L09777.000.0200**

LED retrofit bulb 8W E27 2700K Ra80 1050lm (no dimming) * max 57W E27

IP20

Sorgente luminosa LED inclusa *
LED bulb included *

0,95

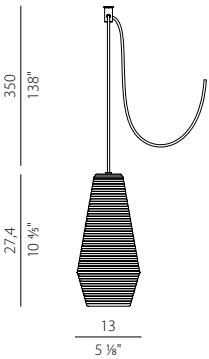

- M09751.000.0200**
- M09752.000.0200**
- M09753.000.0200**
- M09754.000.0200**
- M09755.000.0200**
- M09756.000.0200**
- M09757.000.0200**
- M09771.000.0200**
- M09772.000.0200**
- M09773.000.0200**
- M09774.000.0200**
- M09775.000.0200**
- M09776.000.0200**
- M09777.000.0200**

LED retrofit bulb 8W E27 2700K Ra80 1050lm (no dimming) * max 57W E27

IP20

Fornito senza rosone, con cavo di collegamento 3,5m e appendimento M800, per composizioni multiple. Sorgente luminosa LED inclusa *
Supplied without canopy, with 3,5m cable and M800 polycarbonate hook for multiple configurations. LED bulb included *

0,92

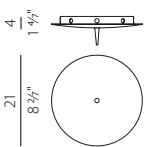

- M91/94/9702**
- M91/94/9719**

Rosone per collegamento elettrico di massimo 9 modelli M091__000.0200/ M094__000.0200/M097__000.0200.

Canopy for power supply up to 9 M091__000.0200/M094__000.0200/ M097__000.0200 models maximum.

0,50

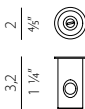

- M800**

Appendimento in policarbonato per sospensione.
Polycarbonate hook for suspension.

0,01

Fotometrie disponibili www.panzeri.it / Photometric data available at www.panzeri.it

CODICI COLORI DISPONIBILI / COLOUR CODES AVAILABLE

51 nero/diffusore bianco black/white diffuser	52 nero/diffusore cristallo black/crystal diffuser	53 nero/diffusore acciaio black/steel diffuser	54 nero/diffusore ambra black/amber diffuser	55 nero/diffusore bronzo black/bronze diffuser	56 nero/diffusore tabacco black/tobacco diffuser	57 nero/diffusore verde black/green diffuser
71 ottone satinato diffusore bianco mat brass white diffuser	72 ottone satinato diffusore cristallo mat brass crystal diffuser	73 ottone satinato/ diffusore acciaio mat brass steel diffuser	74 ottone satinato diffusore ambra mat brass amber diffuser	75 ottone satinato diffusore bronzo mat brass bronze diffuser	76 ottone satinato diffusore tabacco mat brass tobacco diffuser	77 ottone satinato diffusore verde mat brass green diffuser
02 nero black	19 ottone satinato mat brass					

ROSONI E DECENTRAMENTI A PAGINA 171 / OFFSET AND CANOPIES PAGE 171





OLIVIA, EMMA E CLIO

Silvia Poma 2015

Registered Design



Lampada a sospensione in vetro soffiato con particolare finitura a coste dal gusto retrò. Rosone in metallo rifinito con vernice poliaccrilica in color nero o ottone satinato. Emissione di luce diffusa con attacco E27 e lampadina LED con filamenti a vista inclusa. Vetro soffiato disponibile in 7 colorazioni: cristallo, acciaio, ambra, bronzo, tabacco, verde e bianco lucido. Cavi elettrici in tessuto nero con possibilità di personalizzarne la lunghezza. Rosone a 8 uscite (+1 centrale). Ideale per strutture hospitality o zone living residenziali.

Suspension lamp with shaded blown glass with a retro style. Ceiling metal canopy in black polyacrylic paint and in mat brass. Diffused light in LED bulb E27 distinguished by visible filaments. Seven colors glass available: crystal, steel, amber, bronze, tobacco, green and glossy white. Black fabric electrical cables and possibility to customize the length. Canopy with 8 outputs (+1 in the center). Ideal for hospitality or residential facilities.

CODICE CODE	FONTI LUMINOSE LIGHT SOURCES	kg
-------------	------------------------------	----

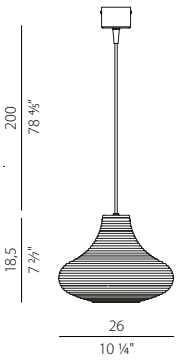

	L09151.000.0200	LED retrofit bulb 8W E27 2700K Ra80 1050lm (no dimming) *	1,50
	L09152.000.0200	max 57W E27	
	L09153.000.0200	IP20	
	L09154.000.0200	Sorgente luminosa LED inclusa *	
	L09155.000.0200	LED bulb included *	
	L09156.000.0200		
	L09157.000.0200		
	L09171.000.0200		
	L09172.000.0200		
	L09173.000.0200		
L09174.000.0200			
L09175.000.0200			
L09176.000.0200			
L09177.000.0200			

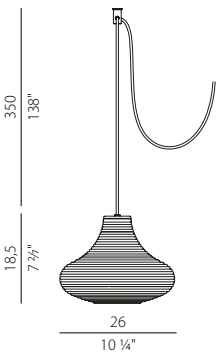

	M09151.000.0200	LED retrofit bulb 8W E27 2700K Ra80 1050lm (no dimming) *	1,47
	M09152.000.0200	max 57W E27	
	M09153.000.0200	IP20	
	M09154.000.0200	Fornito senza rosone, con cavo di collegamento 3,5m e appendimento M800, per composizioni multiple. Sorgente luminosa LED inclusa *	
	M09155.000.0200	Supplied without canopy, with 3,5m cable and M800 polycarbonate hook for multiple configurations. LED bulb included *	
	M09156.000.0200		
	M09157.000.0200		
	M09171.000.0200		
	M09172.000.0200		
	M09173.000.0200		
M09174.000.0200			
M09175.000.0200			
M09176.000.0200			
M09177.000.0200			

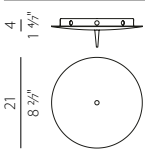

M91/94/9702	Rosone per collegamento elettrico di massimo 9 modelli M091__000.0200/ M094__000.0200/M097__000.0200.	0,50
M91/94/9719	Canopy for power supply up to 9 M091__000.0200/M094__000.0200/ M097__000.0200 models maximum.	

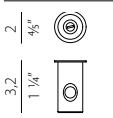

M800	Appendimento in policarbonato per sospensione. Polycarbonate hook for suspension.	0,01
-------------	---	------

Fotometrie disponibili www.panzeri.it / Photometric data available at www.panzeri.it

CODICI COLORI DISPONIBILI / COLOUR CODES AVAILABLE

51 nero/diffusore bianco black/white diffuser	52 nero/diffusore cristallo black/crystal diffuser	53 nero/diffusore acciaio black/steel diffuser	54 nero/diffusore ambra black/amber diffuser	55 nero/diffusore bronzo black/bronze diffuser	56 nero/diffusore tabacco black/tobacco diffuser	57 nero/diffusore verde black/green diffuser
71 ottone satinato diffusore bianco mat brass white diffuser	72 ottone satinato diffusore cristallo mat brass crystal diffuser	73 ottone satinato/ diffusore acciaio mat brass steel diffuser	74 ottone satinato diffusore ambra mat brass amber diffuser	75 ottone satinato diffusore bronzo mat brass bronze diffuser	76 ottone satinato diffusore tabacco mat brass tobacco diffuser	77 ottone satinato diffusore verde mat brass green diffuser
02 nero black	19 ottone satinato mat brass					





Lampada a sospensione in vetro soffiato con particolare finitura a coste dal gusto retrò. Rosone in metallo rifinito con vernice poliaccrilica in color nero o ottone satinato. Emissione di luce diffusa con attacco E27 e lampadina LED con filamenti a vista inclusa. Vetro soffiato disponibile in 7 colorazioni: cristallo, acciaio, ambra, bronzo, tabacco, verde e bianco lucido. Cavi elettrici in tessuto nero con possibilità di personalizzarne la lunghezza. Rosone a 8 uscite (+1 centrale). Ideale per strutture hospitality o zone living residenziali.

Suspension lamp with shaded blown glass with a retro style. Ceiling metal canopy in black polyacrylic paint and in mat brass. Diffused light in LED bulb E27 distinguished by visible filaments. Seven colors glass available: crystal, steel, amber, bronze, tobacco, green and glossy white. Black fabric electrical cables and possibility to customize the length. Canopy with 8 outputs (+1 in the center). Ideal for hospitality or residential facilities.

	CODICE CODE	FONTI LUMINOSE LIGHT SOURCES	kg
	L09451.000.0200	LED retrofit bulb 8W E27 2700K Ra80 1050lm (no dimming) *	1,32
	L09452.000.0200	max 57W E27	
	L09453.000.0200	IP20	
	L09454.000.0200	Sorgente luminosa LED inclusa *	
	L09455.000.0200	LED bulb included *	
	L09456.000.0200		
	L09457.000.0200		
	L09471.000.0200		
	L09472.000.0200		
	L09473.000.0200		
	L09474.000.0200		
	M09451.000.0200	LED retrofit bulb 8W E27 2700K Ra80 1050lm (no dimming) *	1,29
	M09452.000.0200	max 57W E27	
	M09453.000.0200	IP20	
	M09454.000.0200	Fornito senza rosone, con cavo di collegamento 3,5m e appendimento M800, per composizioni multiple. Sorgente luminosa LED inclusa *	
	M09455.000.0200	Supplied without canopy, with 3,5m cable and M800 polycarbonate hook for multiple configurations. LED bulb included *	
	M09456.000.0200		
	M09457.000.0200		
	M09471.000.0200		
	M09472.000.0200		
	M09473.000.0200		
	M09474.000.0200		
	M91/94/9702	Rosone per collegamento elettrico di massimo 9 modelli M091__000.0200/	0,50
	M91/94/9719	M094__000.0200/M097__000.0200. Canopy for power supply up to 9 M091__000.0200/M094__000.0200/M097__000.0200 models maximum.	
	M800	Appendimento in policarbonato per sospensione. Polycarbonate hook for suspension.	0,01

Fotometrie disponibili www.panzeri.it / Photometric data available at www.panzeri.it

CODICI COLORI DISPONIBILI / COLOUR CODES AVAILABLE

51 nero/diffusore bianco black/white diffuser	52 nero/diffusore cristallo black/crystal diffuser	53 nero/diffusore acciaio black/steel diffuser	54 nero/diffusore ambra black/amber diffuser	55 nero/diffusore bronzo black/bronze diffuser	56 nero/diffusore tabacco black/tobacco diffuser	57 nero/diffusore verde black/green diffuser
71 ottone satinato diffusore bianco mat brass white diffuser	72 ottone satinato diffusore cristallo mat brass crystal diffuser	73 ottone satinato/ diffusore acciaio mat brass steel diffuser	74 ottone satinato diffusore ambra mat brass amber diffuser	75 ottone satinato diffusore bronzo mat brass bronze diffuser	76 ottone satinato diffusore tabacco mat brass tobacco diffuser	77 ottone satinato diffusore verde mat brass green diffuser
02 nero black	19 ottone satinato mat brass					



02 nero / black



19 ottone satinato / mat brass





Lampade LED da sospensione e soffitto in tubo tondo di alluminio nei colori: bianco, nero, bronzo, ottone satinato e foglia oro.

LED suspension and ceiling lamp in round aluminium tube. White, black, bronze, mat brass and gold leaf.

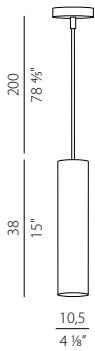

CODICE CODE	FONTI LUMINOSE LIGHT SOURCES	kg
L03701.000.0401	Potenza assorbita apparecchio / Luminaire power consumption 15W Flusso luminoso apparecchio / Luminaire luminous flux 1022lm 3000K Ra>90 220-240V AC ON-OFF IP40	1,47
L03702.000.0401		
L03717.000.0401		
L03719.000.0401		
L03721.000.0401		
L03701.000.0402	Potenza assorbita apparecchio / Luminaire power consumption 15W Flusso luminoso apparecchio / Luminaire luminous flux 1022lm 3000K Ra>90 220-240V AC dimmable (DALI/Push DIM) IP40	1,47
L03702.000.0402		
L03717.000.0402		
L03719.000.0402		
L03721.000.0402		
P03701.000.0401	Potenza assorbita apparecchio / Luminaire power consumption 15W Flusso luminoso apparecchio / Luminaire luminous flux 1022lm 3000K Ra>90 220-240V AC ON-OFF IP40	0,77
P03702.000.0401		
P03717.000.0401		
P03719.000.0401		
P03721.000.0401		
P03701.000.0402	Potenza assorbita apparecchio / Luminaire power consumption 15W Flusso luminoso apparecchio / Luminaire luminous flux 1022lm 3000K Ra>90 220-240V AC dimmable (DALI/Push DIM) IP40	0,77
P03702.000.0402		
P03717.000.0402		
P03719.000.0402		
P03721.000.0402		

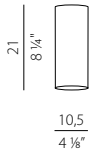

Fotometrie disponibili www.panzeri.it / Photometric data available at www.panzeri.it

CODICI COLORI DISPONIBILI / COLOUR CODES AVAILABLE

- 01** bianco
white
- 02** nero
black
- 17** bronzo
bronze
- 19** ottone satinato
mat brass
- 21** foglia oro
gold leaf

ROSONI E DECENTRAMENTI A PAGINA 171 / OFFSET AND CANOPIES PAGE 171







Famiglia di prodotti da tavolo, parete o soffitto con struttura snodata per il posizionamento ottimale della fonte luminosa rispetto alla superficie di lavoro, ideale in ambienti lavorativi o per l'illuminazione di tavoli e scrivanie in ambito domestico e hospitality. Il telaio è realizzato in alluminio tubolare con elementi snodati in alluminio pressofuso e tiranti in fune di acciaio; la testa orientabile in pressofusione di alluminio è equipaggiata di sorgente LED con intensità e tonalità di luce regolabili secondo la tecnologia DIM-to-warm; l'elettronica di bordo inoltre è configurabile in modalità bianco dinamico, con luce di colorazione variabile da bianco caldo a bianco naturale. Tutti i modelli sono disponibili con verniciatura poliaccrilica in colore bianco, nero satinato, bronzo, ottone satinato o titanio. Per la versione da tavolo disponibili le nuove finiture verde oliva materico e terracotta naturale materico.

Opuntia is a series of table, wall or ceiling-mount lamps with jointed structure for optimal positioning of the light source with respect to the working plan, ideal for workstations or for the illumination of tables and desks in home or hospitality settings. The structure is built in tube-shaped aluminum with jointed elements in aluminum die-cast and tie-rods in steel; the adjustable head in aluminum die-cast is equipped with a LED board with technology DIM-to-warm to regulate light intensity and color temperature accordingly; the electronics onboard allow to set also on tunable white, with fixed light intensity and color temperature ranging from warm white to cold white. All models are available in polyacrylic paint in finish white, satin black, bronze, mat brass and titanium. For table version, new finishes textured olive green and textured natural terracotta are available.

NOVELTY

CODICE CODE

FONTI LUMINOSE LIGHT SOURCES

kg

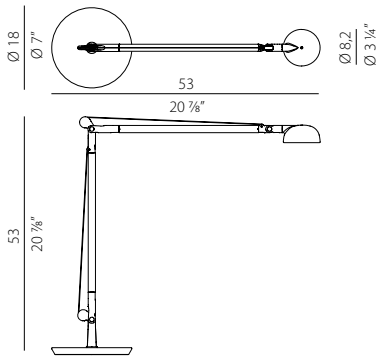

- C06801.000.9121**
- C06806.000.9121**
- C06817.000.9121**
- C06819.000.9121**
- C06827.000.9121**
- C06829.000.9121**
- C06830.000.9121**

Potenza assorbita apparecchio / Luminaire power consumption 8,5W
 Flusso luminoso apparecchio / Luminaire luminous flux 700lm
 2200-4000K Ra>90 220-240V AC DIM-to-warm + tunable white

IP40

3,45



- A06801.130.9121**
- A06806.130.9121**
- A06817.130.9121**
- A06819.130.9121**
- A06830.130.9121**

Potenza assorbita apparecchio / Luminaire power consumption 8,5W
 Flusso luminoso apparecchio / Luminaire luminous flux 700lm
 2200-4000K Ra>90 220-240V AC DIM-to-warm + tunable white

IP40

1,20

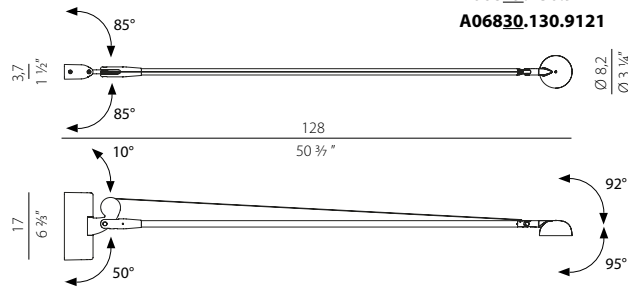

- A06801.180.9121**
- A06806.180.9121**
- A06817.180.9121**
- A06819.180.9121**
- A06830.180.9121**

Potenza assorbita apparecchio / Luminaire power consumption 8,5W
 Flusso luminoso apparecchio / Luminaire luminous flux 700lm
 2200-4000K Ra>90 220-240V AC DIM-to-warm + tunable white

IP40

1,29

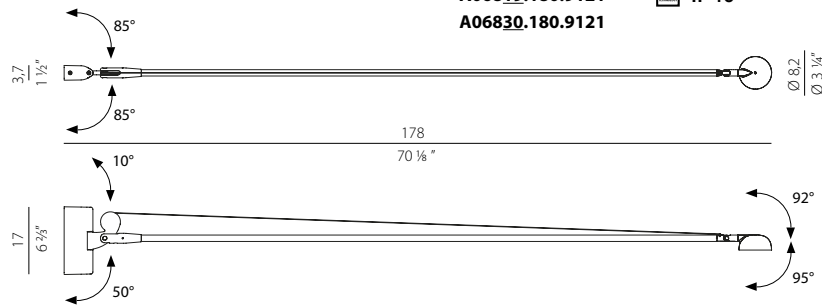



Fotometrie disponibili www.panzeri.it / Photometric data available at www.panzeri.it

CODICI COLORI DISPONIBILI / COLOUR CODES AVAILABLE

- | | | | | | | |
|---------------------------|--------------------------------------|----------------------------|--|--|---|-------------------------------|
| 01 bianco
white | 06 nero satinato
mat black | 17 bronzo
bronze | 19 ottone satinato
mat brass | 27 verde oliva materico
textured olive green | 29 terracotta naturale materico
textured natural terracotta | 30 titanio
titanium |
|---------------------------|--------------------------------------|----------------------------|--|--|---|-------------------------------|











Roris è una famiglia di apparecchi di illuminazione con un forte carattere decorativo ispirato alla natura, capace di adattarsi ed integrarsi, con le diverse versioni, ad ambienti interni eleganti, minimali e moderni, sia residenziali che commerciali. La famiglia Roris prende spunto dalle forme sottili e flessibili della flora, in un gioco di segni e traiettorie che, con semplicità, arreda e illumina l'ambiente. I 6 bracci curvi delle versioni a plafone e a incasso parziale, distribuiti ritmicamente su un corpo centrale affusolato, portano 8 corpi illuminanti di vetro dalla forma tondeggiante simile gocce di rugiada. Sono disponibili anche le versioni da parete e da tavolo, che illuminano lo spazio in maniera diffusa. Tutte le versioni disponibili in finitura nero satinato e ottone satinato.

Roris is a family of lighting fixtures with a strong decorative character inspired by nature, capable of adapting and integrating, with its different versions, into elegant, minimalist and modern interiors, both residential and commercial. The Roris family comes from the thin and flexible forms of flora, in a play of signs and trajectories that simply furnish and illuminate the environment. The 6 curved arms of the surface-mounted and partially recessed versions, rhythmically distributed over a tapered central body, carry 8 glass light fittings with a rounded dewdrop-like shape. Wall and table versions are also available, illuminating the space in a diffuse manner. All versions are available in mat black and mat brass finishes.

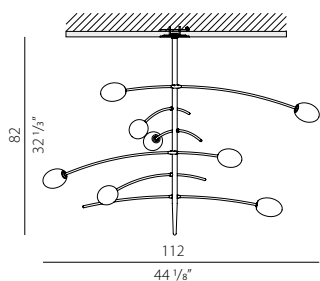
NOVELTY	CODICE CODE	FONTI LUMINOSE LIGHT SOURCES	kg
---------	-------------	------------------------------	----



 **X11206.008.0500**
X11219.008.0500

8x LED retrofit bulb 3,5W G9 2700K Ra80 400lm dimmable
max 4W G9

IP20
Sorgente luminosa LED inclusa
LED bulb included

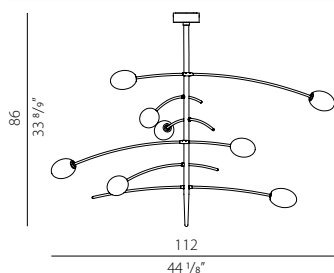
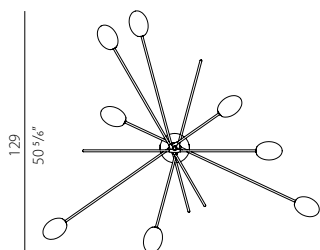

 **P11206.008.0500**
P11219.008.0500

8x LED retrofit bulb 3,5W G9 2700K Ra80 400lm dimmable
max 4W G9

IP20
Sorgente luminosa LED inclusa
LED bulb included

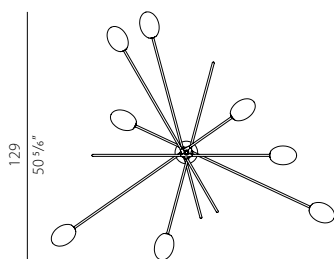





RORIS

Enzo Panzeri 2023

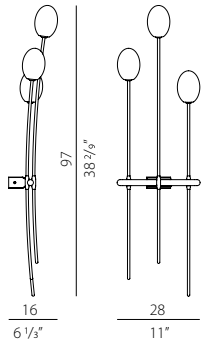
	CODICE CODE	FONTI LUMINOSE LIGHT SOURCES	kg
	A11206.003.0500 A11219.003.0500	3x LED retrofit bulb 3,5W G9 2700K Ra80 400lm dimmable max 4W G9 IP20 Sorgente luminosa LED inclusa LED bulb included	

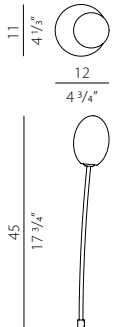
	C11206.001.0500 C11219.001.0500	LED retrofit bulb 3,5W G9 2700K Ra80 400lm dimmable max 4W G9 IP20 ☐ Sorgente luminosa LED inclusa LED bulb included	
--	--	---	--

Fotometrie disponibili www.panzeri.it / Photometric data available at www.panzeri.it

CODICI COLORI DISPONIBILI / COLOUR CODES AVAILABLE

06 nero satinato
mat black

19 ottone satinato
mat brass

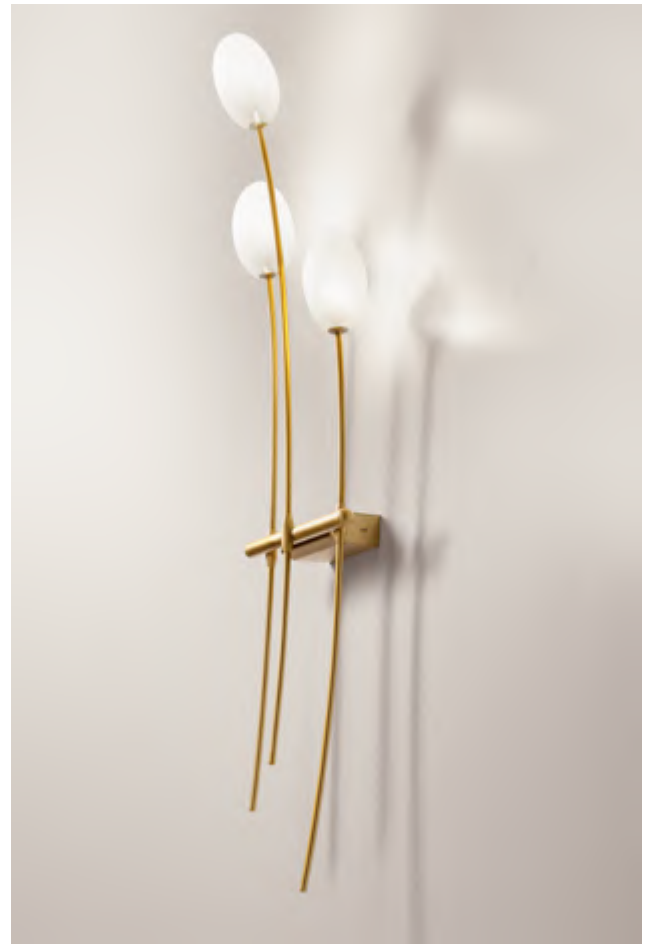









SMOKE

Silvia Poma 2018

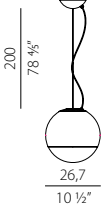

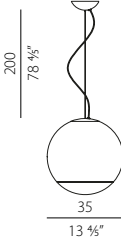
Lampada a sospensione in vetro soffiato lavorato a mano con effetto sfumato. Rosone in metallo spazzolato e verniciato colore titanio. Emissione di luce diffusa con attacco E27, lampadina LED dimmerabile inclusa. Vetro soffiato disponibile in tre misure, in colore bianco sfumato o fumé sfumato. Cavo elettrico trasparente.

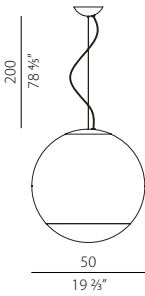
Suspension lamp in handmade blown glass in shaded effect. Metal part brushed and painted in titanium finish. Diffused light emission with E27 socket, LED bulb dimmable included. Blown glass available in three sizes, in shaded white or shaded smoky grey. Transparent electric cable.

	CODICE CODE	FONTI LUMINOSE LIGHT SOURCES	kg
	 L01540.027.0200	LED retrofit bulb 21W E27 2700K Ra80 2500lm Dimmable*	2,46
	 L01541.027.0200	max 116W E27 IP20 Sorgente luminosa LED inclusa* LED bulb included*	
	 L01540.035.0200	LED retrofit bulb 21W E27 2700K Ra80 2500lm Dimmable*	2,90
	 L01541.035.0200	max 116W E27 IP20 Sorgente luminosa LED inclusa* LED bulb included*	
	 L01540.050.0200	LED retrofit bulb 21W E27 2700K Ra80 2500lm Dimmable*	7,02
	 L01541.050.0200	max 116W E27 IP20 Sorgente luminosa LED inclusa* LED bulb included*	

Fotometrie disponibili www.panzeri.it / Photometric data available at www.panzeri.it

CODICI COLORI DISPONIBILI / COLOUR CODES AVAILABLE

40 titanio/diffusore fumé
titanium/smoky grey diffuser

41 titanio/diffusore bianco
titanium/white diffuser





Lampada LED da parete/soffitto in alluminio verniciato poliaccrilico bianco, bronzo, ottone satinato, nero e vetro satinato.

LED wall/ceiling lamp in aluminium colored in white, bronze, mat brass, black polyacrylic paint and mat glass.

	CODICE CODE	FONTI LUMINOSE LIGHT SOURCES	kg
	P03901.011.0406	Potenza assorbita apparecchio / Luminaire power consumption 10W	0,51
	P03902.011.0406	Flusso luminoso apparecchio / Luminaire luminous flux 595lm	
	P03917.011.0406	3000K Ra>90 220-240V AC ON-OFF	
	P03919.011.0406	IP40	
	P03901.015.0406	Potenza assorbita apparecchio / Luminaire power consumption 15W	1,32
	P03902.015.0406	Flusso luminoso apparecchio / Luminaire luminous flux 956lm	
	P03917.015.0406	3000K Ra>90 220-240V AC ON-OFF	
	P03919.015.0406	IP40	
	XM14/230		Dispositivo dimmerabile per moduli LED a 230V, 5÷100W. Dimmable device for 230V LED modules, 5÷100W.

Fotometrie disponibili www.panzeri.it / Photometric data available at www.panzeri.it

CODICI COLORI DISPONIBILI / COLOUR CODES AVAILABLE

01 bianco white **02** nero black **17** bronzo bronze **19** ottone satinato mat brass

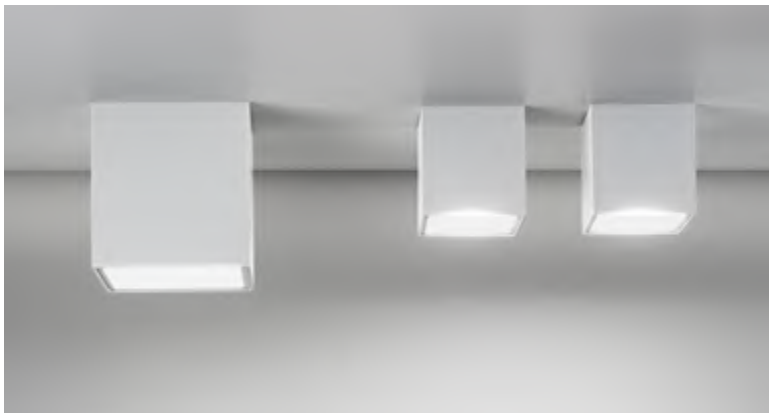
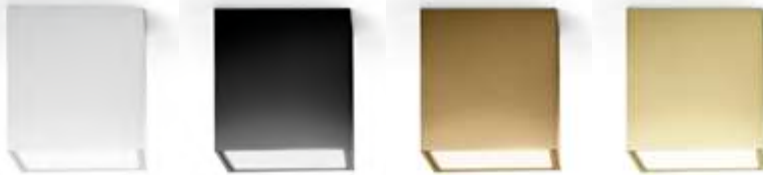



Lampada a sospensione in alluminio estruso disponibile in \varnothing 22mm o \varnothing 32 mm e rispettive lunghezze 850mm/650mm. Lampada a sospensione e plafone in alluminio estruso con \varnothing 55 mm e lunghezza 450mm. La versione con \varnothing 55mm prevede la possibilità di installare tre ottiche con fascio 20°, 35°, 55°. Sorgente luminosa composta da modulo LED ad elevate prestazioni CRI>90 2700K. Rosone con driver ON-OFF integrato nella versione \varnothing 22mm. Driver ON-OFF integrato nel cilindro nella versione \varnothing 32mm e 55mm. Finitura con vernice poliaccrilica in bianco, nero satinato, bronzo, ottone satinato o finitura in foglia oro decorata a mano. Cavo elettrico trasparente ultrasottile. Ideale per ristoranti, zone living, camere da letto o per creare grandi composizioni a cascata.

Aluminum extruded suspension lamp in \varnothing 22mm or \varnothing 32mm diameter and respectively 850mm/650mm length. Aluminum extruded suspension and ceiling lamp in \varnothing 55mm and length 450mm. The version in \varnothing 55mm is available with three different beam angles 20°, 35°, 55°. Light sources made of highly performing LED module with CRI>90 2700K. Canopy with ON-OFF driver integrated in the \varnothing 22mm version. Integrated ON-OFF driver inside the cylinder for the versions \varnothing 32mm and 55mm. Finish in white, mat black, bronze, mat brass polyacrylic paint or hand-made decorated in golden leaf. Ultra-thin transparent electrical cable. Ideal for restaurants, living areas, bedrooms, and to create big cascading compositions.

	CODICE CODE	FONTI LUMINOSE LIGHT SOURCES	kg
	L02501.085.0501	Potenza assorbita apparecchio / Luminaire power consumption 4W	0,75
	L02506.085.0501	Flusso luminoso apparecchio / Luminaire luminous flux 181lm	
	L02517.085.0501	2700K Ra>90 220-240V AC ON-OFF	
	L02519.085.0501	IP40	
	L02521.085.0501		
	L02601.065.0501	Potenza assorbita apparecchio / Luminaire power consumption 7W	0,74
	L02606.065.0501	Flusso luminoso apparecchio / Luminaire luminous flux 363lm	
	L02617.065.0501	2700K Ra>90 220-240V AC ON-OFF	
	L02619.065.0501	IP40	
	L02621.065.0501		
	L02701.045.1701	Potenza assorbita apparecchio / Luminaire power consumption 10W	1,13
	L02706.045.1701	Flusso luminoso apparecchio / Luminaire luminous flux 806lm	
	L02717.045.1701	2700K Ra>90 35° 220-240V AC ON-OFF	
	L02719.045.1701	IP20	
	L02721.045.1701	Per progetti a richiesta ottiche a 20° e 55° Beam angles 20°, 55° on request for projects	

	CODICE CODE	FONTI LUMINOSE LIGHT SOURCES	kg
	M02501.085.0510	Potenza assorbita apparecchio / Luminaire power consumption 2,8W	0,64
	M02506.085.0510	Flusso luminoso apparecchio / Luminaire luminous flux 181lm	
	M02517.085.0510	2700K Ra>90 24V DC	
	M02519.085.0510	IP40	
	M02521.085.0510	Fornito con cavo di collegamento 5m, senza rosone e driver, per composizioni multiple o in combinazione con Hilow Supplied with 5m cable, without canopy and driver, for multiple configurations or configurations with Hilow	
	M02601.065.0510	Potenza assorbita apparecchio / Luminaire power consumption 5,3W	0,76
	M02606.065.0510	Flusso luminoso apparecchio / Luminaire luminous flux 363lm	
	M02617.065.0510	2700K Ra>90 24V DC	
	M02619.065.0510	IP40	
	M02621.065.0510	Fornito senza rosone e driver, per composizioni multiple Supplied without canopy and driver, for multiple configurations	
	M800	Appendimento in policarbonato per sospensione. Polycarbonate hook for suspension.	0,01
	P02701.045.1701	Potenza assorbita apparecchio / Luminaire power consumption 10W	0,85
	P02706.045.1701	Flusso luminoso apparecchio / Luminaire luminous flux 806lm	
	P02717.045.1701	2700K Ra>90 35° 220-240V AC ON-OFF	
	P02719.045.1701	IP20	
	P02721.045.1701	Per progetti a richiesta ottiche a 20° e 55° Beam angles 20°, 55° on request for projects	

Fotometrie disponibili www.panzeri.it / Photometric data available at www.panzeri.it

CODICI COLORI DISPONIBILI / COLOUR CODES AVAILABLE

- 01** bianco white **06** nero satinato mat black **17** bronzo bronze **19** ottone satinato mat brass **21** foglia oro gold leaf

ROSONI E DECENTRAMENTI A PAGINA 171 / OFFSET AND CANOPIES PAGE 171





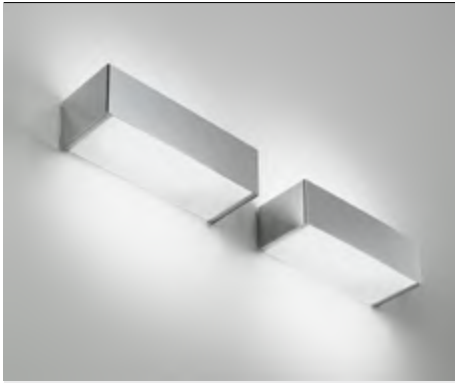

Lampade a parete con fascia in metallo o acciaio e diffusore in vetro. Emissione di luce diretta e indiretta ottenuta da una fonte luminosa LED. Fascia metallica rifinita con vernice poliaccrilica in bianco, bronzo, ottone satinato o decorata a mano con foglia oro oppure fascia metallica in acciaio inox lucida o satinata. La fascia esterna non presenta viti a vista, perché fissata con meccanismo elastico. Ideale per ambienti residenziali e progetti moderni e minimalistici.

Wall lamps in metal or steel cover and glass diffuser. Direct and indirect light provided by LED sources. Metal cover in white, bronze, mat brass polyacrylic paint or hand-decorated golden leaf, or in polished or mat stainless steel. The metal cover has no visible screws since fastened by an elastic mechanism. Ideal for residential use and modern and minimalist projects.

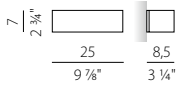

CODICE CODE	FONTI LUMINOSE LIGHT SOURCES	kg
A01601.025.0401	Potenza assorbita apparecchio / Luminaire power consumption 13W	0,82
A01617.025.0401	Flusso luminoso apparecchio / Luminaire luminous flux 878lm	
A01619.025.0401	3000K Ra>90 220-240V AC ON-OFF	
A01621.025.0401	IP20	
A01637.025.0401		
A01639.025.0401		

A01601.025.0402	Potenza assorbita apparecchio / Luminaire power consumption 13W	0,82
A01617.025.0402	Flusso luminoso apparecchio / Luminaire luminous flux 878lm	
A01619.025.0402	3000K Ra>90 220-240V AC dimmable (DALI/Push DIM)	
A01621.025.0402	IP20	
A01637.025.0402		
A01639.025.0402		

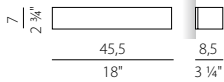

A01601.045.0401	Potenza assorbita apparecchio / Luminaire power consumption 24W	1,61
A01617.045.0401	Flusso luminoso apparecchio / Luminaire luminous flux 1755lm	
A01619.045.0401	3000K Ra>90 220-240V AC ON-OFF	
A01621.045.0401	IP20	
A01637.045.0401		
A01639.045.0401		

A01601.045.0402	Potenza assorbita apparecchio / Luminaire power consumption 24W	1,61
A01617.045.0402	Flusso luminoso apparecchio / Luminaire luminous flux 1755lm	
A01619.045.0402	3000K Ra>90 220-240V AC dimmable (DALI/Push DIM)	
A01621.045.0402	IP20	
A01637.045.0402		
A01639.045.0402		

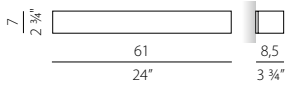

A01601.060.0401	Potenza assorbita apparecchio / Luminaire power consumption 35W	2,21
A01617.060.0401	Flusso luminoso apparecchio / Luminaire luminous flux 2633lm	
A01619.060.0401	3000K Ra>90 220-240V AC ON-OFF	
A01621.060.0401	IP20	
A01637.060.0401		
A01639.060.0401		

A01601.060.0402	Potenza assorbita apparecchio / Luminaire power consumption 35W	2,21
A01617.060.0402	Flusso luminoso apparecchio / Luminaire luminous flux 2633lm	
A01619.060.0402	3000K Ra>90 220-240V AC dimmable (DALI/Push DIM)	
A01621.060.0402	IP20	
A01637.060.0402		
A01639.060.0402		

Fotometrie disponibili www.panzeri.it / Photometric data available at www.panzeri.it

CODICI COLORI DISPONIBILI / COLOUR CODES AVAILABLE

Disponibili a richiesta LED 2700K / On request 2700K LED available

01 bianco white	17 bronzo bronze	19 ottone satinato mat brass	21 foglia oro gold leaf	37 acciaio lucido polished steel	39 acciaio satinato mat steel
---------------------------	----------------------------	--	-----------------------------------	--	---







Lampada a sospensione, tavolo, parete/soffitto (disponibile anche a incasso) e terra in alluminio tornito con accensione ON-OFF e cavo trasparente. Tubino parete/soffitto è particolarmente adatta in applicazione alla testata del letto, sia in ambito residenziale che hospitality. Nella versione terra le sorgenti raddoppiano, il posizionamento sulla struttura a stelo è pensato per consentirne l'utilizzo anche come lampada da lettura. La versione tavolo è disponibile nella variante Tubino Plus con comando Step DIM a 5 regolazioni dell'intensità luminosa in finitura champagne, bronzo o titanio con cavo di alimentazione tra la testa e la struttura in tessuto colorato.

Suspension, table, wall / ceiling (also available as recessed) and floor lamp in turned aluminium with ON-OFF ignition and transparent cable. Tubino wall / ceiling can be easily applied to the bedhead, both in residential and hospitality projects. In the floor version the lighting sources double, the positioning on the stem structure is designed to allow an use also as a reading lamp. The table version is also available as Tubino plus with Step DIM control and 5 light intensity settings. Champagne bronze and titanium finishes with fabric colored cable between the head and the structure.

CODICE CODE	FONTI LUMINOSE LIGHT SOURCES	kg
-------------	------------------------------	----

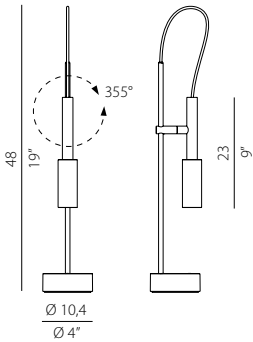

C07301.001.0501
C07306.001.0501

Potenza assorbita apparecchio / Luminaire power consumption 6,5W
Flusso luminoso apparecchio / Luminaire luminous flux 339lm
2700K Ra>90 220-240V AC ON-OFF

1,42

IP20

Cavo trasparente
Transparent cable

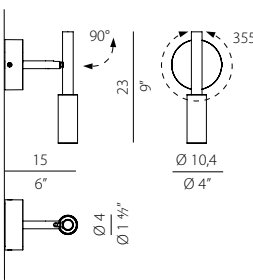

A07301.001.0501
A07305.001.0501
A07306.001.0501
A07317.001.0501
A07330.001.0501

Potenza assorbita apparecchio / Luminaire power consumption 6,5W
Flusso luminoso apparecchio / Luminaire luminous flux 339lm
2700K Ra>90 220-240V AC ON-OFF

0,62

IP20

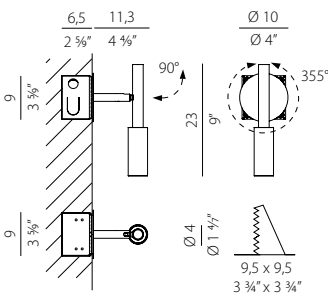

X07301.001.0501
X07305.001.0501
X07306.001.0501
X07317.001.0501
X07330.001.0501

Potenza assorbita apparecchio / Luminaire power consumption 6,5W
Flusso luminoso apparecchio / Luminaire luminous flux 339lm
2700K Ra>90 220-240V AC ON-OFF

1,09

IP20

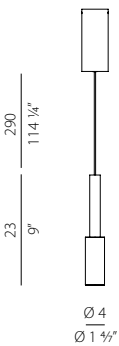

L07301.001.0501
L07305.001.0501
L07306.001.0501
L07317.001.0501
L07330.001.0501

Potenza assorbita apparecchio / Luminaire power consumption 6,5W
Flusso luminoso apparecchio / Luminaire luminous flux 339lm
2700K Ra>90 220-240V AC ON-OFF

0,51

IP20

Cavo trasparente
Transparent cable

TUBINO

Matteo Thun 2019/2020

Registered Design

	CODICE CODE	FONTI LUMINOSE LIGHT SOURCES	kg
	T07301.002.0501	Potenza assorbita apparecchio / Luminaire power consumption 13W	4,49
	T07306.002.0501	Flusso luminoso apparecchio / Luminaire luminous flux 2 x 339lm 2700K Ra>90 220-240V AC ON-OFF	
		IP20	
		Cavo trasparente Transparent cable	

Fotometrie disponibili www.panzeri.it / Photometric data available at www.panzeri.it

CODICI COLORI DISPONIBILI / COLOUR CODES AVAILABLE

01 bianco white **05** champagne champagne **06** nero satinato mat black **17** bronzo bronze **30** titanio titanium







TUBINO



Matteo Thun 2019

Registered Design



Lampada da tavolo in alluminio tornito. Tubino Plus è disponibile in versione con comando Step DIM a 5 regolazioni di intensità luminosa in finitura champagne, bronzo e titanio con cavo di alimentazione tra la testa e la struttura in tessuto.

Aluminium table in turned aluminium. Tubino Plus is available with Step DIM control with 5 light intensity settings in champagne, bronze and titanium finish with fabric cable between the head and the structure.

CODICE CODE	FONTI LUMINOSE LIGHT SOURCES	kg
 C07305.001.0509	Potenza assorbita apparecchio / Luminaire power consumption 6,5W	1,42
C07317.001.0509	Flusso luminoso apparecchio / Luminaire luminous flux 339lm	
C07330.001.0509	2700K Ra>90 220-240V AC dimmable (Step DIM)	
	 IP20 	
	Finitura champagne con cavo in tessuto color champagne, bronzo con cavo in tessuto bourdeaux, titanio con cavo in tessuto verde.	
	Interruttore incluso / Switch included	
	Champagne with champagne fabric cable, bronze with bourdeaux fabric cable, titanium with green fabric cable.	

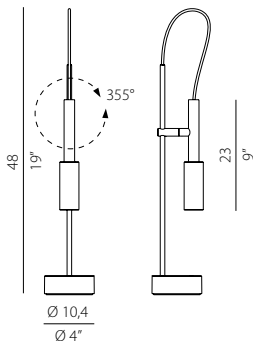

Fotometrie disponibili www.panzeri.it / Photometric data available at www.panzeri.it

CODICI COLORI DISPONIBILI / COLOUR CODES AVAILABLE

- 05** champagne / champagne
- 17** bronzo / bronze
- 30** titanio / titanium



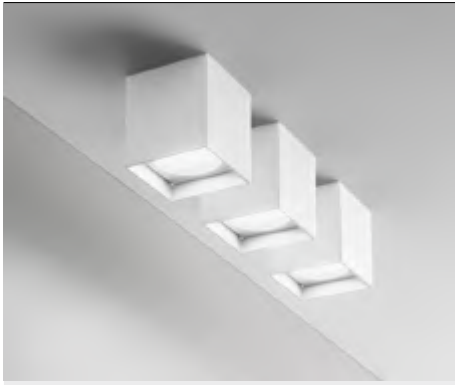

Lampade LED da sospensione e soffitto in tubo quadro di alluminio nei colori: bianco, nero, bronzo, ottone satinato e foglia oro.

LED suspension and ceiling lamp in squared aluminium tube. White, black, bronze, mat brass or gold leaf.

CODICE CODE	FONTI LUMINOSE LIGHT SOURCES	kg
-------------	------------------------------	----



L03801.000.0406

Potenza assorbita apparecchio / Luminaire power consumption 10W

1,63

L03802.000.0406

Flusso luminoso apparecchio / Luminaire luminous flux 595lm

L03817.000.0406

3000K Ra>90 220-240V AC ON-OFF

L03819.000.0406

IP40

L03821.000.0406

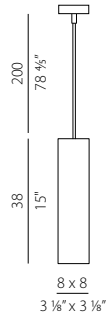

P03801.000.0406

Potenza assorbita apparecchio / Luminaire power consumption 10W

0,39

P03802.000.0406

Flusso luminoso apparecchio / Luminaire luminous flux 595lm

P03817.000.0406

3000K Ra>90 220-240V AC ON-OFF

P03819.000.0406

IP40

P03821.000.0406

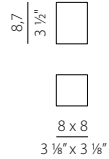

XM14/230

Dispositivo dimmerabile per moduli LED a 230V, 5÷100W.
Dimmable device for 230V LED modules, 5÷100W.

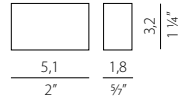

Fotometrie disponibili www.panzeri.it / Photometric data available at www.panzeri.it

CODICI COLORI DISPONIBILI / COLOUR CODES AVAILABLE

01 bianco
white

02 nero
black

17 bronzo
bronze

19 ottone satinato
mat brass

21 foglia oro
gold leaf

ROSONI E DECENTRAMENTI A PAGINA 171 / OFFSET AND CANOPIES PAGE 171





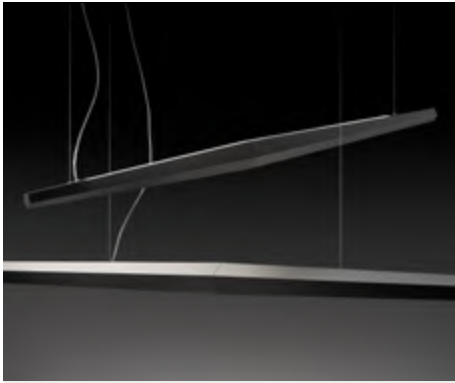

Lampada a sospensione e da terra con sezione pentagonale in alluminio piegato e inciso. Sorgente luminosa composta da modulo LED e dimmerazione di serie DALI/Push DIM integrata nel corpo della lampada tramite driver ultra-flat di ultima generazione. Versione a sospensione disponibile in due lunghezze (120 e 210cm) a luce diretta. Disponibile versione a sospensione a luce indiretta, ideale per creare composizioni in combinazione con la versione a luce diretta. Disponibile versione da terra con base realizzata in metallo tagliato a laser, piegato, e verniciato. Finitura con vernice poliacrilica in bianco o nero. Ideale per uffici, zone living, e in composizione per arredare grandi spazi.

Suspension and floor lamp with pentagonal section in folded and carved aluminum. Light source made of LED module and DALI/Push DIM ultra-flat driver integrated in the suspended body of the fitting. Suspended version available in two dimensions (120 and 210cm) with direct down light. Availability of an indirect up light suspension version, ideal to create compositions in combination with the direct down light version. Floor version with base in metal laser-cut, bent and painted. Finished in polyacrylic paint in white or black. Ideal for offices, living areas, and in compositions to furnish large spaces.

	CODICE CODE	FONTI LUMINOSE LIGHT SOURCES	kg
	L02001.120.0402 L02002.120.0402	Potenza assorbita apparecchio / Luminaire power consumption 23W Flusso luminoso apparecchio / Luminaire luminous flux 1188lm 3000K Ra>90 220-240V AC dimmable (DALI/Push DIM) IP40	1,45
	L02001.210.0402 L02002.210.0402	Potenza assorbita apparecchio / Luminaire power consumption 44W Flusso luminoso apparecchio / Luminaire luminous flux 2376lm 3000K Ra>90 220-240V AC dimmable (DALI/Push DIM) IP40	2,80
	L02101.210.0402 L02102.210.0402	Potenza assorbita apparecchio / Luminaire power consumption 44W Flusso luminoso apparecchio / Luminaire luminous flux 2376lm 3000K Ra>90 220-240V AC dimmable (DALI/Push DIM) IP40	3,00
	T02001.210.0402 T02002.210.0402	Potenza assorbita apparecchio / Luminaire power consumption 44W Flusso luminoso apparecchio / Luminaire luminous flux 2376lm 3000K Ra>90 220-240V AC dimmable (Push DIM) IP20	6,94

Fotometrie disponibili www.panzeri.it / Photometric data available at www.panzeri.it

CODICI COLORI DISPONIBILI / COLOUR CODES AVAILABLE

Disponibili a richiesta LED 2700K / On request 2700K LED available

01 bianco
white

02 nero
black



reddot award 2018
winner

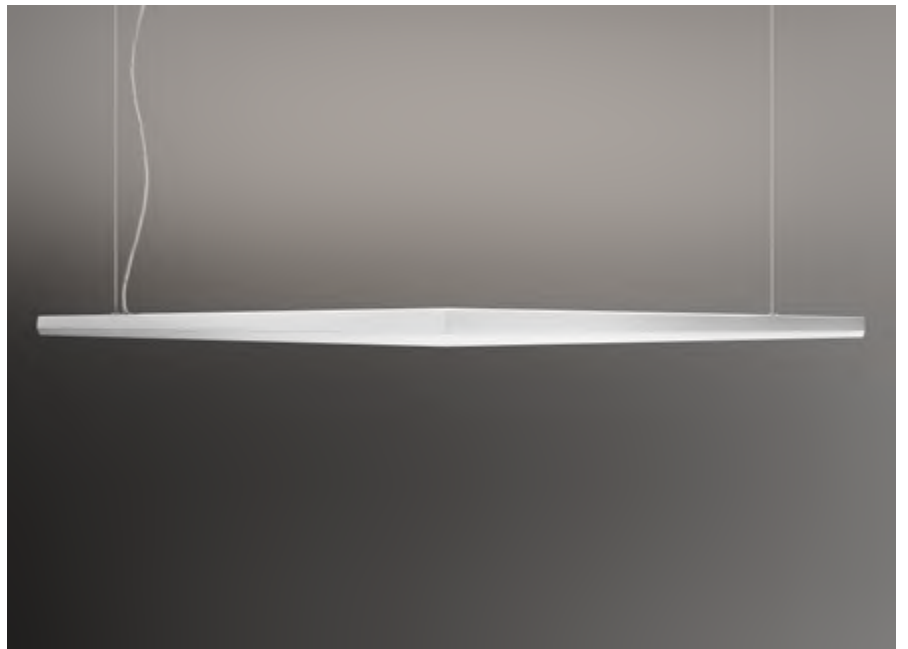



Suspensioni in vetro soffiato bianco satinato o decorato nero ø 40cm, ø 50cm e ø 60cm con diffusore in lastra di vetro. Montature in grigio metallizzato.

Suspensions in white blown or black painted glass, ø 40cm, ø 50cm and ø 60cm with glass sheet as diffuser. Fittings in metallized grey metal.

	CODICE CODE	FONTI LUMINOSE LIGHT SOURCES	kg
	L07631.040.0000	LED retrofit bulb E27 (L max 120mm - Ø max 65mm) max 150W E27 IP20	3,96
	L07633.040.0000	LED retrofit bulb E27 (L max 120mm - Ø max 65mm) max 150W E27 IP20	3,96
	L07631.050.0000	LED retrofit bulb E27 (L max 120mm - Ø max 65mm) max 150W E27 IP20	5,74
	L07633.050.0000	LED retrofit bulb E27 (L max 120mm - Ø max 65mm) max 150W E27 IP20	5,74
	L07631.060.0402	Potenza assorbita apparecchio / Luminaire power consumption 40W Flusso luminoso apparecchio / Luminaire luminous flux 3587lm 3000K Ra>90 220-240V AC dimmable (DALI/Push DIM) IP20	8,38
	L07633.060.0402	Potenza assorbita apparecchio / Luminaire power consumption 40W Flusso luminoso apparecchio / Luminaire luminous flux 3587lm 3000K Ra>90 220-240V AC dimmable (DALI/Push DIM) IP20	8,38
	L07631.060.0000	3x LED retrofit bulb E27 (L max 140mm - Ø max 65mm) 3x max 100W E27 IP20	8,38
	L07633.060.0000	3x LED retrofit bulb E27 (L max 140mm - Ø max 65mm) 3x max 100W E27 IP20	8,38

Fotometrie disponibili www.panzeri.it / Photometric data available at www.panzeri.it

CODICI COLORI DISPONIBILI / COLOUR CODES AVAILABLE

31 grigio metallizzato/diffusore nero
metallized grey/black diffuser

33 grigio metallizzato/diffusore bianco
metallized grey/white diffuser







Lampada a parete costituita da una barra in ottone. Luce indiretta emessa attraverso schermo in policarbonato semiopale. Fonte luminosa costituita da modulo LED. Struttura rifinita con vernice poliaccrilica in colore bianco, nero, bronzo, ottone satinato o cromata. Due versioni disponibili: montatura incassata nel muro o montatura esterna. Nessun elemento di fissaggio a vista. Ideale per ambienti residenziali o moderne strutture hospitality.

Wall lamp in brass bar. Indirect light emitted through a semi-opal polycarbonate screen. LED module. Fitting in white, black, bronze, mat brass polyacrylic paint or in chrome version. Two available versions: recessed mounting in the wall or external mounting. No visible fastening element. Ideal for residential spaces or modern hospitality facilities.

	CODICE CODE	FONTI LUMINOSE LIGHT SOURCES	kg
	A07201.000.0401	Potenza assorbita apparecchio / Luminaire power consumption 13W	0,59
	A07202.000.0401	Flusso luminoso apparecchio / Luminaire luminous flux 1046lm	
	A07217.000.0401	3000K Ra>90 220-240V AC ON-OFF	
	A07219.000.0401	IP20	
	A07222.000.0401		

	X07201.000.0401	Potenza assorbita apparecchio / Luminaire power consumption 13W	0,59
	X07202.000.0401	Flusso luminoso apparecchio / Luminaire luminous flux 1046lm	
	X07217.000.0401	3000K Ra>90 220-240V AC ON-OFF	
	X07219.000.0401	IP20	
	X07222.000.0401		

Fotometrie disponibili www.panzeri.it / Photometric data available at www.panzeri.it

CODICI COLORI DISPONIBILI / COLOUR CODES AVAILABLE

01 bianco white **02** nero black **17** bronzo bronze **19** ottone satinato mat brass **22** cromo chrome







Lampade da parete/soffitto in metallo bianco, cromo, bronzo, ottone satinato e foglia oro complete di LED e driver.

Wall/ceiling lamps in white metal, chrome, bronze, mat brass and gold leaf complete with LED and driver.

	CODICE CODE	FONTI LUMINOSE LIGHT SOURCES	kg
	A03501.050.0401	Potenza assorbita apparecchio / Luminaire power consumption 11W	0,92
	A03517.050.0401	Flusso luminoso apparecchio / Luminaire luminous flux 613lm	
	A03519.050.0401	3000K Ra>90 220-240V AC ON-OFF	
	A03521.050.0401	IP20	
	A03522.050.0401		
	A03501.100.0401	Potenza assorbita apparecchio / Luminaire power consumption 20W	1,58
	A03517.100.0401	Flusso luminoso apparecchio / Luminaire luminous flux 1227lm	
	A03519.100.0401	3000K Ra>90 220-240V AC ON-OFF	
	A03521.100.0401	IP20	
	A03522.100.0401		

Fotometrie disponibili www.panzeri.it / Photometric data available at www.panzeri.it

CODICI COLORI DISPONIBILI / COLOUR CODES AVAILABLE

Disponibili a richiesta LED 2700K / On request 2700K LED available

01 bianco
white

17 bronzo
bronze

19 ottone satinato
mat brass

21 foglia oro
gold leaf

22 cromo
chrome







ZERO SHAPES

Enzo Panzeri 2022

Registered Design



Lampada a sospensione orizzontale in alluminio estruso curvato, con schermo in policarbonato opale. Emissione interna attraverso modulo LED e tecnologia ZigBee di serie su tutte le versioni inserita nel rosone. Anello rifinito con vernice poliaccrilica color bianco, nero, titanio, bronzo e ottone satinato. Ideale per ambienti residenziali e zone living.

Horizontal suspension lamp in extruded curved aluminum, with opal polycarbonate screen. Emission on the internal side provided by LED modules with ZigBee technology integrated into the canopy. Polyacrilic paint white, black, titanium, bronze and mat brass finishes are available. Ideal for residential spaces and living areas.

	CODICE CODE	FONTI LUMINOSE LIGHT SOURCES	kg
	L03301.050.0523	Potenza assorbita apparecchio / Luminaire power consumption 25W	0,83
	L03302.050.0523	Flusso luminoso apparecchio / Luminaire luminous flux 2039lm	
	L03317.050.0523	2700K Ra>90 220-240V AC dimmable (ZigBee)	
	L03319.050.0523	IP20	
	L03330.050.0523		
	L03301.075.0523	Potenza assorbita apparecchio / Luminaire power consumption 36W	1,12
	L03302.075.0523	Flusso luminoso apparecchio / Luminaire luminous flux 3059lm	
	L03317.075.0523	2700K Ra>90 220-240V AC dimmable (ZigBee)	
	L03319.075.0523	IP20	
	L03330.075.0523		
	L03301.100.0523	Potenza assorbita apparecchio / Luminaire power consumption 47W	1,43
	L03302.100.0523	Flusso luminoso apparecchio / Luminaire luminous flux 4079lm	
	L03317.100.0523	2700K Ra>90 220-240V AC dimmable (ZigBee)	
	L03319.100.0523	IP20	
	L03330.100.0523		

YCO.T001



Telecomando per dispositivi wireless ZigBee, per accensione/spengimento e regolazione di 4 gruppi di massimo 30 corpi illuminanti.

Remote controller for ZigBee wireless devices, supporting switch and dimming control of 4 groups with up to 30 lighting fixtures maximum.

Fotometrie disponibili www.panzeri.it / Photometric data available at www.panzeri.it

CODICI COLORI DISPONIBILI / COLOUR CODES AVAILABLE

01 bianco white	02 nero black	17 bronzo bronze	19 ottone satinato mat brass	30 titanio titanium
---------------------------	-------------------------	----------------------------	--	-------------------------------

ZERO ROUND SMART

Zero Round Smart è collegabile facilmente alle reti domestiche esistenti e non richiede modifiche all'impianto elettrico.

Accensione, spegnimento e regolazione della luce possono avvenire in diversi modi, tramite telecomando, smartphone, assistente vocale, ...

Di seguito alcuni esempi di configurazioni possibili.

Zero Round Smart could be easily connected to existing home networks and does not require modification to electrical system.

Switching on, switching off and dimming of the light could be obtained in various ways, through remote control, smartphone, voice assistant...

As follow some examples of possible configurations.



L'apparecchio d'illuminazione può essere controllato grazie al telecomando (accessorio). **Non richiede una connessione internet o modifiche all'impianto elettrico.**

Lighting fixtures could be controlled by remote control (accessory). **It does not require an internet connection or modifications to the electrical system.**

ZERO ROUND SMART

Esempio 02 / Example 02

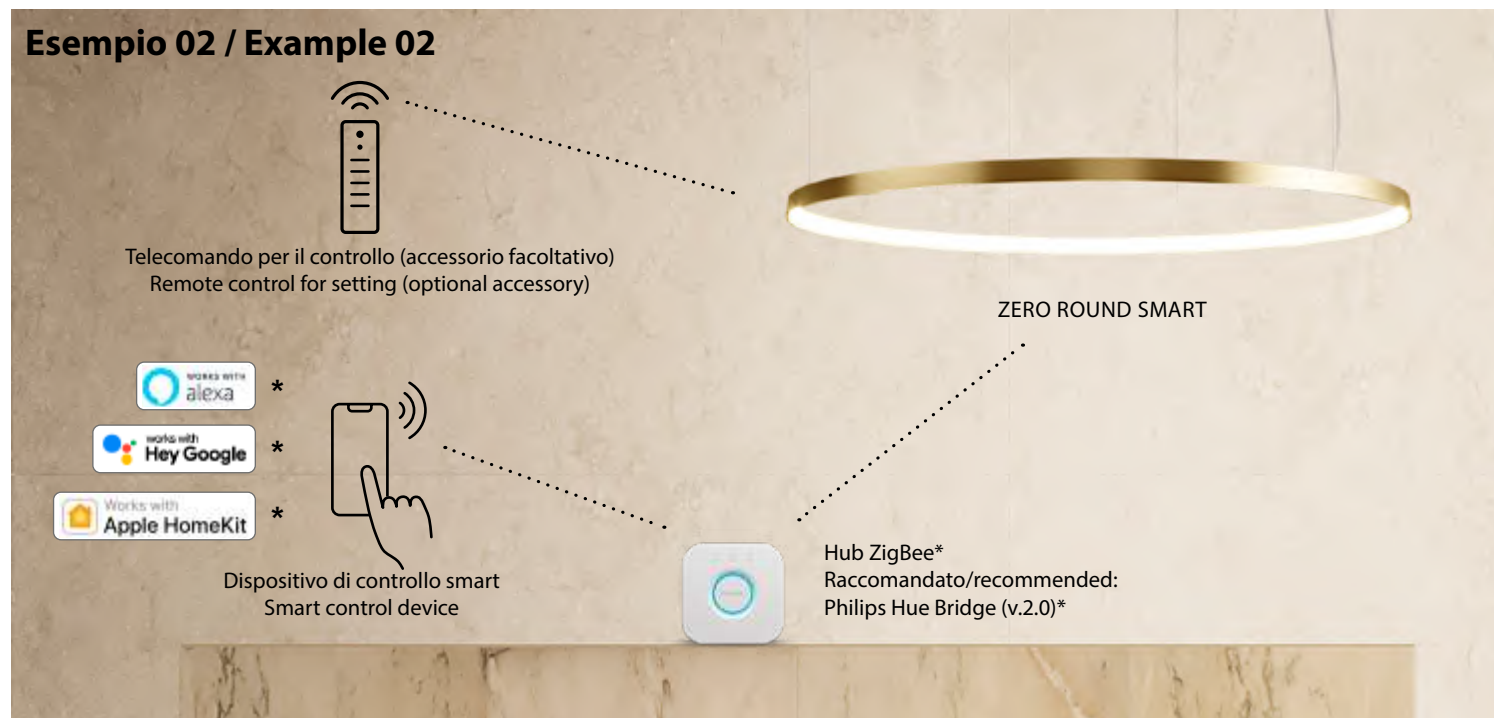

L'apparecchio d'illuminazione può essere controllato tramite assistente vocale e altri dispositivi di controllo smart, come smartphone, ecc. Necessita di una connessione internet e di un hub ZigBee* (ad esempio Philips Hue Bridge v.2.0*, raccomandato). Possibilità di controllo anche tramite telecomando. **Non sono necessarie modifiche all'impianto elettrico.**

Lighting fixtures could be controlled by voice assistant and other smart control devices, such as smartphones, etc. Internet connection and ZigBee* hub required (e.g. Philips Hue Bridge v.2.0*, recommended). Possibility of control also by remote control. **Modifications to the electrical system not required.**

Esempio 03 / Example 03

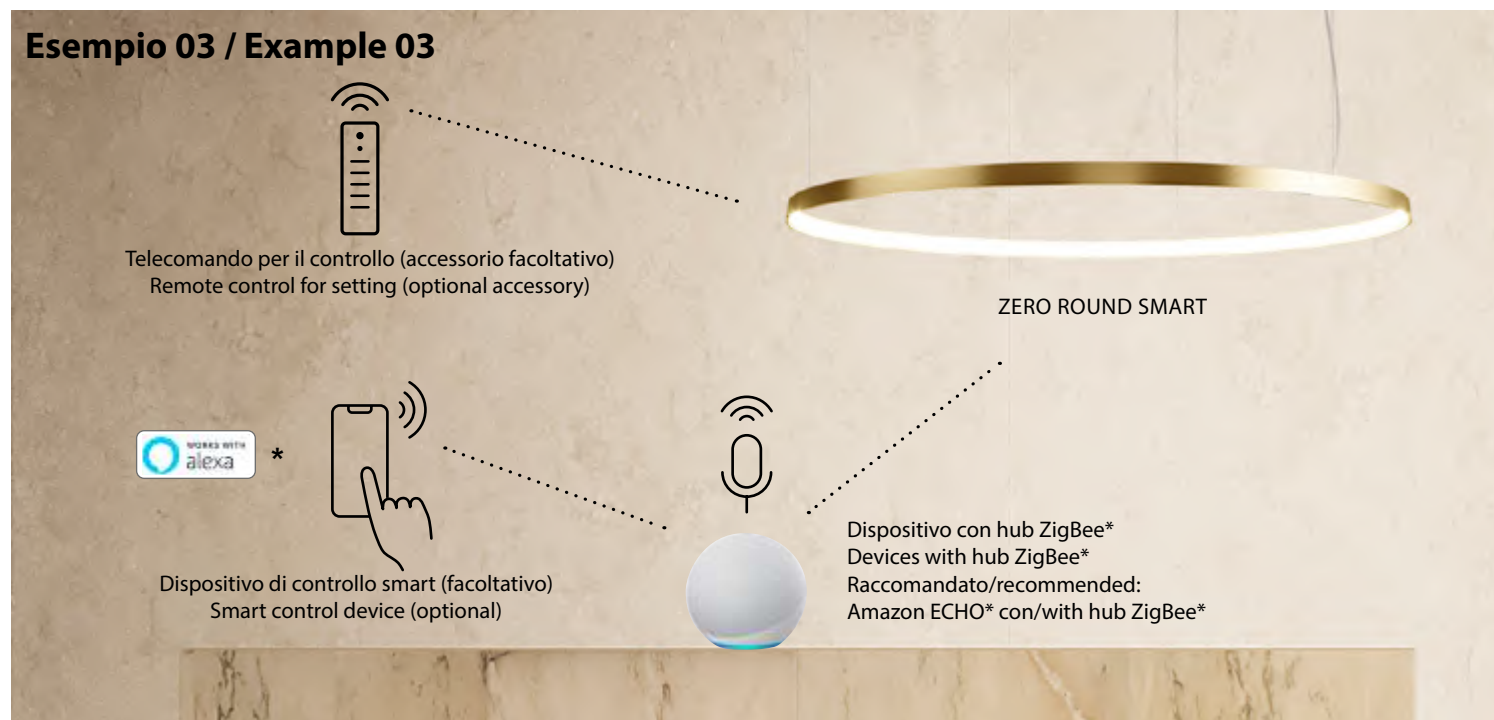

L'apparecchio d'illuminazione può essere controllato tramite assistente vocale e dispositivi di controllo smart, come smartphone, ecc. Necessita di una connessione internet Wi-Fi e di un assistente vocale con hub ZigBee* integrato (Amazon Echo* con hub ZigBee* raccomandato). Possibilità di controllo anche tramite telecomando. **Non sono necessarie modifiche all'impianto elettrico.**

Lighting fixtures could be controlled by voice assistant and smart control devices, such as smartphones, etc. Wi-Fi internet connection and voice assistant with integrated ZigBee* hub required (Amazon Echo* with hub ZigBee* recommended). Possibility of control also by remote control. **Modifications to the electrical system not required.**

*ZigBee, Philips Hue Bridge, Amazon Echo, Alexa, Hey Google e Apple HomeKit sono marchi registrati di terzi senza alcun collegamento con Panzeri Carlo s.r.l.

*ZigBee, Philips Hue Bridge, Amazon Echo, Alexa, Hey Google e Apple HomeKit are registered trademarks without any relationship with Panzeri Carlo s.r.l.



ZERO SHAPES

Enzo Panzeri 2018

Registered Design



Lampada a sospensione orizzontale, a parete e a soffitto in alluminio estruso curvato, con schermo in policarbonato opale. Emissione interna attraverso modulo LED e tecnologia DALI/Push DIM di serie su tutte le versioni inserita nel rosone. Anello rifinito con vernice poliaccrilica color bianco, nero, titanio, bronzo e ottone satinato. Disponibilità di rosone per installazioni singole e per composizioni multiple da ordinare separatamente. Ideale per uffici, hall, zone living, grandi spazi, anche in abbinamento con Zero Round Acoustic e Arena Acoustic.

Horizontal suspension lamp, wall and ceiling lamp in extruded curved aluminum, with opal polycarbonate screen. Emission on the internal side provided by LED modules with technology DALI/Push DIM integrated into the canopy. Polyacrilic paint white, black, titanium, bronze and mat brass finishes are available. Canopies for single and multiple configurations with Zero Ellipse and Zero Square are available, to be ordered separately. Ideal for offices, halls, living, and public spaces, also combined with Zero Round Acoustic and Arena Acoustic.

	CODICE CODE	FONTI LUMINOSE LIGHT SOURCES	kg
	P03301.050.0502	Potenza assorbita apparecchio / Luminaire power consumption 29W	1,41
	P03302.050.0502	Flusso luminoso apparecchio / Luminaire luminous flux 2039lm	
	P03317.050.0502	2700K Ra>90 220-240V AC dimmable (DALI/Push DIM)	
	IP20		
	P03330.050.0502		
	P03301.075.0502	Potenza assorbita apparecchio / Luminaire power consumption 42W	1,80
	P03302.075.0502	Flusso luminoso apparecchio / Luminaire luminous flux 3059lm	
	P03317.075.0502	2700K Ra>90 220-240V AC dimmable (DALI/Push DIM)	
	IP20		
	P03330.075.0502		
	P03301.075.0402	Potenza assorbita apparecchio / Luminaire power consumption 42W	1,80
	P03302.075.0402	Flusso luminoso apparecchio / Luminaire luminous flux 3059lm	
	P03317.075.0402	3000K Ra>90 220-240V AC dimmable (DALI/Push DIM)	
	IP20		
	P03330.075.0402		
	P03301.100.0502	Potenza assorbita apparecchio / Luminaire power consumption 54W	2,06
	P03302.100.0502	Flusso luminoso apparecchio / Luminaire luminous flux 4079lm	
	P03317.100.0502	2700K Ra>90 220-240V AC dimmable (DALI/Push DIM)	
	IP20		
	P03330.100.0502		
	P03301.100.0402	Potenza assorbita apparecchio / Luminaire power consumption 54W	2,06
	P03302.100.0402	Flusso luminoso apparecchio / Luminaire luminous flux 4079lm	
	P03317.100.0402	3000K Ra>90 220-240V AC dimmable (DALI/Push DIM)	
	IP20		
	P03330.100.0402		

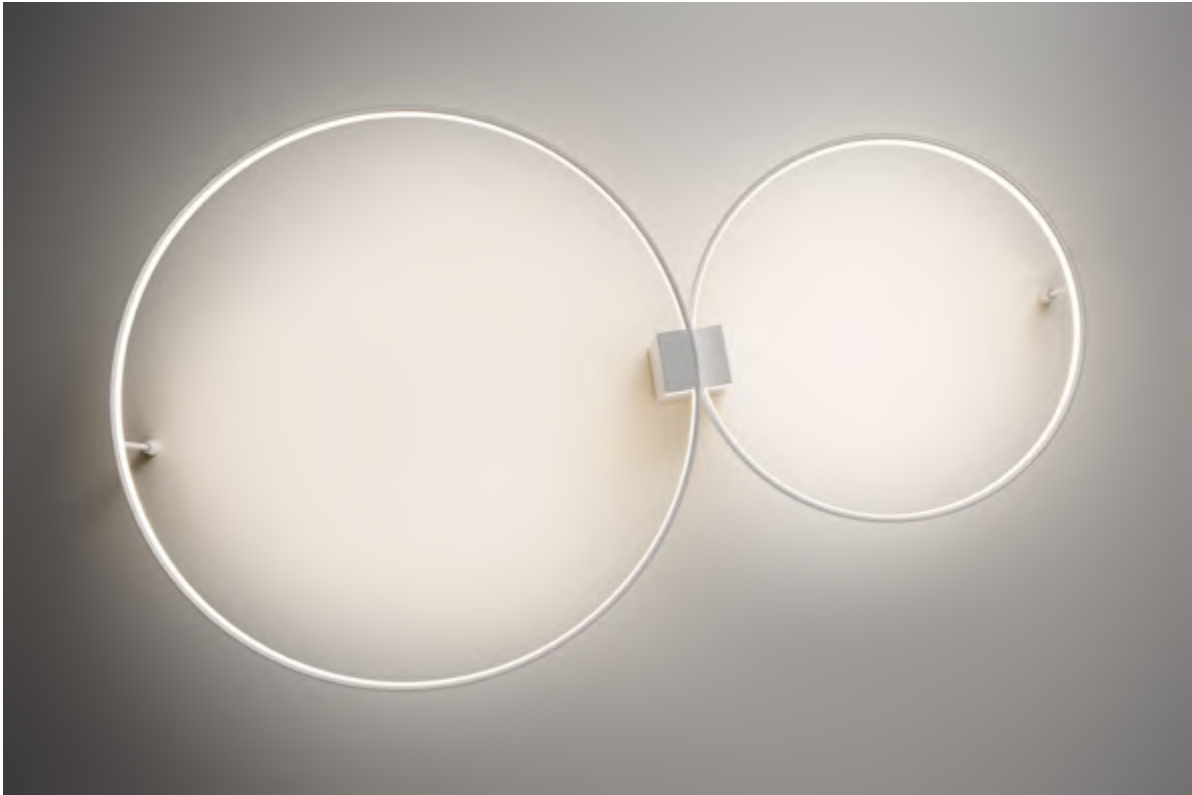

ZERO SHAPES

Enzo Panzeri 2018

Registered Design

	CODICE CODE	FONTI LUMINOSE LIGHT SOURCES	kg
	M10301.125.0510 M10302.125.0510 M10317.125.0510 M10319.125.0510 M10330.125.0510	Potenza assorbita apparecchio / Luminaire power consumption 62W Flusso luminoso apparecchio / Luminaire luminous flux 5099lm 2700K Ra>90 24V DC LED IP20	
	M10301.125.0410 M10302.125.0410 M10317.125.0410 M10319.125.0410 M10330.125.0410	Potenza assorbita apparecchio / Luminaire power consumption 62W Flusso luminoso apparecchio / Luminaire luminous flux 5099lm 3000K Ra>90 24V DC LED IP20	Fornito senza rosone e driver, per composizioni singole o multiple Supplied without canopy and driver, for multiple configurations
	M10301.150.0510 M10302.150.0510 M10317.150.0510 M10319.150.0510 M10330.150.0510	Potenza assorbita apparecchio / Luminaire power consumption 71W Flusso luminoso apparecchio / Luminaire luminous flux 6120lm 2700K Ra>90 24V DC LED IP20	
	M10301.150.0410 M10302.150.0410 M10317.150.0410 M10319.150.0410 M10330.150.0410	Potenza assorbita apparecchio / Luminaire power consumption 71W Flusso luminoso apparecchio / Luminaire luminous flux 6120lm 3000K Ra>90 24V DC LED IP20	Fornito senza rosone e driver, per composizioni singole o multiple Supplied without canopy and driver, for multiple configurations
	M10301.200.0510 M10302.200.0510 M10317.200.0510 M10319.200.0510 M10330.200.0510	Potenza assorbita apparecchio / Luminaire power consumption 88W Flusso luminoso apparecchio / Luminaire luminous flux 8158lm 2700K Ra>90 24V DC LED IP20	
	M10301.200.0410 M10302.200.0410 M10317.200.0410 M10319.200.0410 M10330.200.0410	Potenza assorbita apparecchio / Luminaire power consumption 88W Flusso luminoso apparecchio / Luminaire luminous flux 8158lm 3000K Ra>90 24V DC LED IP20	Fornito senza rosone e driver, per composizioni singole o multiple Supplied without canopy and driver, for multiple configurations
	XM10301.521.0002 XM10302.521.0002 XM10317.521.0002 XM10319.521.0002 XM10330.521.0002	Rosone per alimentazione di 1 modello Zero Round 125 - Zero Round 150 - Zero Round 200, con driver DALI/Push DIM. Canopy for power supply of 1 Zero Round 125 - Zero Round 150 - Zero Round 200 model, with DALI/Push DIM driver.	

ZERO SHAPES

Enzo Panzeri 2018

Registered Design

	CODICE CODE	FONTI LUMINOSE LIGHT SOURCES	kg
	M03301.050.0510 M03302.050.0510 M03317.050.0510 M03319.050.0510 M03330.050.0510	Potenza assorbita apparecchio / Luminaire power consumption 25W Flusso luminoso apparecchio / Luminaire luminous flux 2039lm 2700K Ra>90 24V DC IP20	0,83
	M03301.050.0410 M03302.050.0410 M03317.050.0410 M03319.050.0410 M03330.050.0410	Potenza assorbita apparecchio / Luminaire power consumption 25W Flusso luminoso apparecchio / Luminaire luminous flux 2039lm 3000K Ra>90 24V DC IP20	0,83
	M03301.075.0510 M03302.075.0510 M03317.075.0510 M03319.075.0510 M03330.075.0510	Potenza assorbita apparecchio / Luminaire power consumption 36W Flusso luminoso apparecchio / Luminaire luminous flux 3059lm 2700K Ra>90 24V DC IP20	1,12
	M03301.075.0410 M03302.075.0410 M03317.075.0410 M03319.075.0410 M03330.075.0410	Potenza assorbita apparecchio / Luminaire power consumption 36W Flusso luminoso apparecchio / Luminaire luminous flux 3059lm 3000K Ra>90 24V DC IP20	1,12
	M03301.100.0510 M03302.100.0510 M03317.100.0510 M03319.100.0510 M03330.100.0510	Potenza assorbita apparecchio / Luminaire power consumption 47W Flusso luminoso apparecchio / Luminaire luminous flux 4079lm 2700K Ra>90 24V DC IP20	1,43
	M03301.100.0410 M03302.100.0410 M03317.100.0410 M03319.100.0410 M03330.100.0410	Potenza assorbita apparecchio / Luminaire power consumption 47W Flusso luminoso apparecchio / Luminaire luminous flux 4079lm 3000K Ra>90 24V DC IP20	1,43
	A03301.025.0501 A03302.025.0501 A03317.025.0501 A03319.025.0501 A03330.025.0501	Potenza assorbita apparecchio / Luminaire power consumption 13W Flusso luminoso apparecchio / Luminaire luminous flux 796lm 2700K Ra>90 220-240V AC ON-OFF IP40	0,62
	A03301.025.0401 A03302.025.0401 A03317.025.0401 A03319.025.0401 A03330.025.0401	Potenza assorbita apparecchio / Luminaire power consumption 13W Flusso luminoso apparecchio / Luminaire luminous flux 796lm 3000K Ra>90 220-240V AC ON-OFF IP40	0,62

Fotometrie disponibili www.panzeri.it / Photometric data available at www.panzeri.it

CODICI COLORI DISPONIBILI / COLOUR CODES AVAILABLE

01 bianco white **02** nero black **17** bronzo bronze **19** ottone satinato mat brass **30** titanio titanium

ROSONI PER ZERO SHAPES A PAGINA 158 / CANOPIES FOR ZERO SHAPES ON PAGE 158

















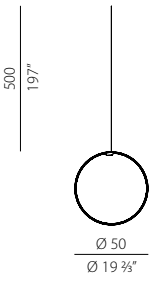

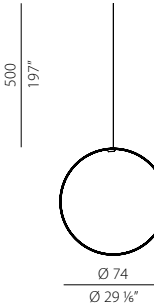

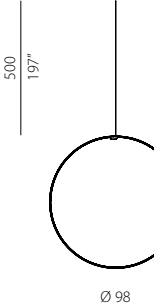

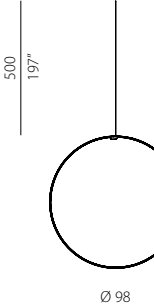



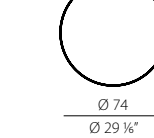

ZERO SHAPES

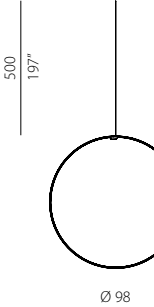
Enzo Panzeri 2018

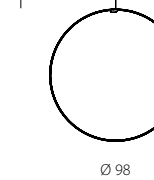

Lampada a sospensione verticale in alluminio estruso curvato con schermo in policarbonato opale. Emissione interna attraverso modulo LED e tecnologia DALI/Push DIM di serie su tutte le versioni inserita nel rosone. Anello rifinito con vernice poliaccrilica color bianco, nero, titanio, bronzo e ottone satinato. Possibili colori custom su richiesta. Disponibilità di rosone per installazioni singole e rosone per composizioni multiple da ordinare separatamente. Ideale per uffici, hall, zone living, grandi spazi, anche in abbinamento con **Zero Round Acoustic** e **Arena Acoustic**.

Vertical suspension lamp in extruded curved aluminum with opal polycarbonate screen. Emission of internal light through LED module and DALI/Push DIM technology on all the versions in the canopy. Polyacrylic white, black titanium bronze or mat brass painted. Canopy for single installations and canopies for multiple configurations are available, to be ordered separately. Ideal for offices, halls, living areas, large spaces, also combined with **Zero Round Acoustic** and **Arena Acoustic**.

	CODICE CODE	FONTI LUMINOSE LIGHT SOURCES	kg
 <p>500 197"</p> <p>Ø 50 Ø 19 3/8"</p>	 M03401.050.0510	Potenza assorbita apparecchio / Luminaire power consumption 25W	0,81
	M03402.050.0510	Flusso luminoso apparecchio / Luminaire luminous flux 2039lm	
	M03417.050.0510	2700K Ra>90 24V DC	
	M03419.050.0510	 IP20 	
	M03430.050.0510	Fornito senza rosone e driver, per composizioni singole o multiple Supplied without canopy and driver, for multiple configurations	
 <p>500 197"</p> <p>Ø 74 Ø 29 1/4"</p>	 M03401.050.0410	Potenza assorbita apparecchio / Luminaire power consumption 25W	0,81
	M03402.050.0410	Flusso luminoso apparecchio / Luminaire luminous flux 2039lm	
	M03417.050.0410	3000K Ra>90 24V DC	
	M03419.050.0410	 IP20 	
	M03430.050.0410	Fornito senza rosone e driver, per composizioni singole o multiple Supplied without canopy and driver, for multiple configurations	
 <p>500 197"</p> <p>Ø 74 Ø 29 1/4"</p>	 M03401.075.0510	Potenza assorbita apparecchio / Luminaire power consumption 36W	1,09
	M03402.075.0510	Flusso luminoso apparecchio / Luminaire luminous flux 3059lm	
	M03417.075.0510	2700K Ra>90 24V DC	
	M03419.075.0510	 IP20 	
	M03430.075.0510	Fornito senza rosone e driver, per composizioni singole o multiple Supplied without canopy and driver, for multiple configurations	
 <p>500 197"</p> <p>Ø 74 Ø 29 1/4"</p>	 M03401.075.0410	Potenza assorbita apparecchio / Luminaire power consumption 36W	1,09
	M03402.075.0410	Flusso luminoso apparecchio / Luminaire luminous flux 3059lm	
	M03417.075.0410	3000K Ra>90 24V DC	
	M03419.075.0410	 IP20 	
	M03430.075.0410	Fornito senza rosone e driver, per composizioni singole o multiple Supplied without canopy and driver, for multiple configurations	
 <p>500 197"</p> <p>Ø 98 Ø 38 3/4"</p>	 M03401.100.0510	Potenza assorbita apparecchio / Luminaire power consumption 47W	1,39
	M03402.100.0510	Flusso luminoso apparecchio / Luminaire luminous flux 4079lm	
	M03417.100.0510	2700K Ra>90 24V DC	
	M03419.100.0510	 IP20 	
	M03430.100.0510	Fornito senza rosone e driver, per composizioni singole o multiple Supplied without canopy and driver, for multiple configurations	
 <p>500 197"</p> <p>Ø 98 Ø 38 3/4"</p>	 M03401.100.0410	Potenza assorbita apparecchio / Luminaire power consumption 47W	1,39
	M03402.100.0410	Flusso luminoso apparecchio / Luminaire luminous flux 4079lm	
	M03417.100.0410	3000K Ra>90 24V DC	
	M03419.100.0410	 IP20 	
	M03430.100.0410	Fornito senza rosone e driver, per composizioni singole o multiple Supplied without canopy and driver, for multiple configurations	

Fotometrie disponibili www.panzeri.it / Photometric data available at www.panzeri.it

CODICI COLORI DISPONIBILI / COLOUR CODES AVAILABLE

01 bianco white **02** nero black **17** bronzo bronze **19** ottone satinato mat brass **30** titanio titanium

ROSONI PER ZERO SHAPES A PAGINA 158 / CANOPIES FOR ZERO SHAPES ON PAGE 158







ZERO SHAPES

Enzo Panzeri 2019



Lampada a sospensione in alluminio estruso curvato con schermo in policarbonato opale. Emissione interna attraverso modulo LED e tecnologia DALI/Push DIM di serie su tutte le versioni inserita nel rosone. Anello rifinito con vernice poliaccrilica color bianco, nero, titanio, bronzo e ottone satinato. Possibili colori custom su richiesta. Disponibilità di rosone per installazioni singole e composizioni multiple in abbinamento a Zero Round e Zero Square da ordinare separatamente. Ideale per uffici, hall, zone living, grandi spazi, anche con **Zero Round Acoustic** e **Arena Acoustic**.

Suspension lamp in extruded curved aluminium with opal polycarbonate screen. Emission on the internal side provided by LED modules with technology DALI/ Push DIM integrated into the canopy. Polyacrilic paint white, black, titanium, bronze and mat brass finishes are available. Custom colors are available on request. Canopies for single and multiple configurations with Zero Round and Zero Square are available, to be ordered separately. Ideal for offices, halls, living, and public spaces, also combined with **Zero Round Acoustic** and **Arena Acoustic**.

	CODICE CODE	FONTI LUMINOSE LIGHT SOURCES	kg
	M03101.130.0510	Potenza assorbita apparecchio / Luminaire power consumption 47W	1,53
	M03102.130.0510	Flusso luminoso apparecchio / Luminaire luminous flux 4079lm	
	M03117.130.0510	2700K Ra>90 24V DC	
	M03119.130.0510	IP20	
	M03130.130.0510	Fornito senza rosone e driver, per composizioni singole o multiple Supplied without canopy and driver, for multiple configurations	
	M03101.130.0410	Potenza assorbita apparecchio / Luminaire power consumption 47W	1,53
	M03102.130.0410	Flusso luminoso apparecchio / Luminaire luminous flux 4079lm	
	M03117.130.0410	3000K Ra>90 24V DC	
	M03119.130.0410	IP20	
	M03130.130.0410	Fornito senza rosone e driver, per composizioni singole o multiple Supplied without canopy and driver, for multiple configurations	

Fotometrie disponibili www.panzeri.it / Photometric data available at www.panzeri.it

CODICI COLORI DISPONIBILI / COLOUR CODES AVAILABLE

- 01** bianco white
- 02** nero black
- 17** bronzo bronze
- 19** ottone satinato mat brass
- 30** titanio titanium

ROSONI PER ZERO SHAPES A PAGINA 158 / CANOPIES FOR ZERO SHAPES ON PAGE 158







ZERO SHAPES

Enzo Panzeri 2019



Lampada a sospensione in alluminio estruso curvato con schermo in policarbonato opale. Emissione interna attraverso modulo LED e tecnologia DALI/Push DIM di serie su tutte le versioni inserita nel rosone. Anello rifinito con vernice poliaccrilica color bianco, nero, titanio, bronzo e ottone satinato. Possibili colori custom su richiesta. Disponibilità di rosone per installazioni singole e composizioni multiple in abbinamento a Zero Ellipse e Zero Round da ordinare separatamente. Ideale per uffici, hall, zone living, grandi spazi, anche in abbinamento con **Zero Round Acoustic** e **Arena Acoustic**.

Suspension lamp in extruded curved aluminium with opal polycarbonate screen. Emission on the internal side provided by LED modules with technology DALI/ Push DIM integrated into the canopy. Polyacrylic paint white, black, titanium, bronze and mat brass finishes are available. Custom colors are available on request. Canopies for single and multiple configurations with Zero Ellipse and Zero Round are available, to be ordered separately. Ideal for offices, halls, living, and public spaces, also combined with **Zero Round Acoustic** and **Arena Acoustic**.

	CODICE CODE	FONTI LUMINOSE LIGHT SOURCES	kg
	M03201.050.0510	Potenza assorbita apparecchio / Luminaire power consumption 25W	0,92
	M03202.050.0510	Flusso luminoso apparecchio / Luminaire luminous flux 2039lm	
	M03217.050.0510	2700K Ra>90 24V DC	
	M03219.050.0510	IP20	
	M03230.050.0510	Fornito senza rosone e driver, per composizioni singole o multiple Supplied without canopy and driver, for multiple configurations	
	M03201.050.0410	Potenza assorbita apparecchio / Luminaire power consumption 25W	0,92
	M03202.050.0410	Flusso luminoso apparecchio / Luminaire luminous flux 2039lm	
	M03217.050.0410	3000K Ra>90 24V DC	
	M03219.050.0410	IP20	
	M03230.050.0410	Fornito senza rosone e driver, per composizioni singole o multiple Supplied without canopy and driver, for multiple configurations	
	M03201.075.0510	Potenza assorbita apparecchio / Luminaire power consumption 36W	1,21
	M03202.075.0510	Flusso luminoso apparecchio / Luminaire luminous flux 3059lm	
	M03217.075.0510	2700K Ra>90 24V DC	
	M03219.075.0510	IP20	
	M03230.075.0510	Fornito senza rosone e driver, per composizioni singole o multiple Supplied without canopy and driver, for multiple configurations	
	M03201.075.0410	Potenza assorbita apparecchio / Luminaire power consumption 36W	1,21
	M03202.075.0410	Flusso luminoso apparecchio / Luminaire luminous flux 3059lm	
	M03217.075.0410	3000K Ra>90 24V DC	
	M03219.075.0410	IP20	
	M03230.075.0410	Fornito senza rosone e driver, per composizioni singole o multiple Supplied without canopy and driver, for multiple configurations	

Fotometrie disponibili www.panzeri.it / Photometric data available at www.panzeri.it

CODICI COLORI DISPONIBILI / COLOUR CODES AVAILABLE

- 01** bianco
white
- 02** nero
black
- 17** bronzo
bronze
- 19** ottone satinato
mat brass
- 30** titanio
titanium

ROSONI PER ZERO SHAPES A PAGINA 158 / CANOPIES FOR ZERO SHAPES ON PAGE 158





ROSONI ZERO SHAPES / ZERO SHAPES CANOPIES



Rosoni per composizioni di apparecchi della famiglia Zero Shapes fino a 100cm di diametro. Finitura con vernice poliacrilica color bianco, nero, titanio, bronzo e ottone satinato. Possibili colori custom su richiesta.

Canopies for configurations of Zero shapes lighting fixtures up to 100cm diameter. Polyacrylic paint white, black, titanium, bronze and mat brass finishes available. Custom colors are available on request.

	CODICE CODE	FONTI LUMINOSE LIGHT SOURCES	kg
	XM03301.511.0002 XM03302.511.0002 XM03317.511.0002 XM03319.511.0002 XM03330.511.0002	Rosone per alimentazione di 1 modello Zero Shapes, con driver 60W/24V DALI/ Push DIM.	0,7
	XM03301.522.0002 XM03302.522.0002 XM03317.522.0002 XM03319.522.0002 XM03330.522.0002	Rosone per alimentazione di 2 modelli Zero Shapes, con n.2 driver 60W/24V DALI/ Push DIM.	2,93
	XM03301.523.0002 XM03302.523.0002 XM03317.523.0002 XM03319.523.0002 XM03330.523.0002	Rosone per alimentazione di 3 modelli Zero Shapes, con n.3 driver 60W/24V DALI/ Push DIM.	3,02
	XM03301.524.0002 XM03302.524.0002 XM03317.524.0002 XM03319.524.0002 XM03330.524.0002	Rosone per alimentazione di 4 modelli Zero Shapes, con n.4 driver 60W/24V DALI/ Push DIM.	3,11



ROSONI ZERO SHAPES / ZERO SHAPES CANOPIES

kg

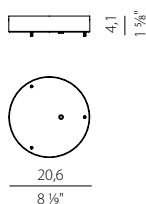
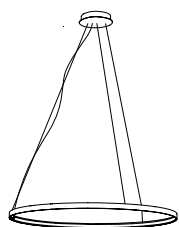

XM03301.531.0002
XM03302.531.0002
XM03317.531.0002
XM03319.531.0002
XM03330.531.0002

Rosone per alimentazione e sospensione di 1 modello Zero Shapes Horizontal, con driver 60W/24V DALI/Push DIM.

Canopy for power supply and suspension of 1 Zero Shapes Horizontal model, with 60W/24V DALI/Push DIM driver.

0,7

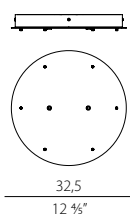
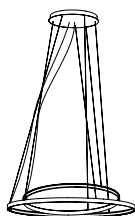

XM03301.532.0002
XM03302.532.0002
XM03317.532.0002
XM03319.532.0002
XM03330.532.0002

Rosone per alimentazione e sospensione di 2 modelli Zero Shapes Horizontal, con n.2 driver 60W/24V DALI/Push DIM.

Canopy for power supply and suspension of 2 Zero Shapes Horizontal models, with n.2 60W/24V DALI/Push DIM drivers.

3,04

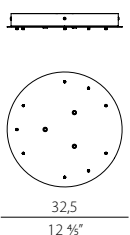
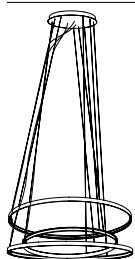

XM03301.533.0002
XM03302.533.0002
XM03317.533.0002
XM03319.533.0002
XM03330.533.0002

Rosone per alimentazione e sospensione di 3 modelli Zero Shapes Horizontal, con n.3 driver 60W/24V DALI/Push DIM.

Canopy for power supply and suspension of 3 Zero Shapes Horizontal models, with n.3 60W/24V DALI/Push DIM drivers.

3,29

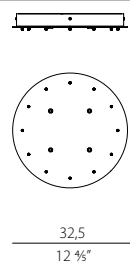
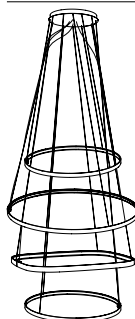

XM03301.534.0002
XM03302.534.0002
XM03317.534.0002
XM03319.534.0002
XM03330.534.0002

Rosone per alimentazione e sospensione di 4 modelli Zero Shapes Horizontal, con n.4 driver 60W/24V DALI/Push DIM.

Canopy for power supply and suspension of 4 Zero Shapes Horizontal models, with n.4 60W/24V DALI/Push DIM drivers.

3,56

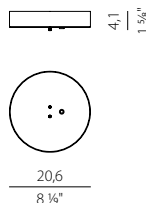
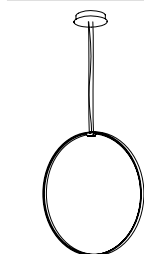

XM03401.531.0002
XM03402.531.0002
XM03417.531.0002
XM03419.531.0002
XM03430.531.0002

Rosone per alimentazione e sospensione di 1 modello Zero Round Vertical, con driver 60W/24V DALI/Push DIM.

Canopy for power supply and suspension of 1 Zero Round Vertical model, with 60W/24V DALI/Push DIM drivers.

1,05

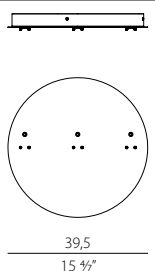
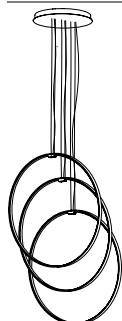

XM03401.533.0002
XM03402.533.0002
XM03417.533.0002
XM03419.533.0002
XM03430.533.0002

Rosone per alimentazione e sospensione di 3 modelli Zero Round Vertical, con n.3 driver 60W/24V DALI/Push DIM.

Canopy for power supply and suspension of 3 Zero Round Vertical models, with n.3 60W/24V DALI/Push DIM drivers.

4,26

ROSONI ZERO SHAPES / ZERO SHAPES CANOPIES

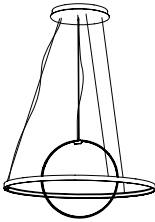
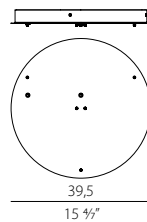
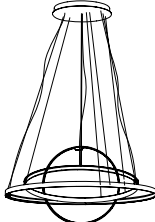
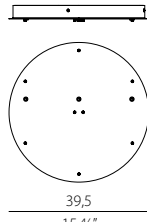
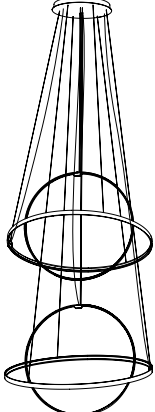
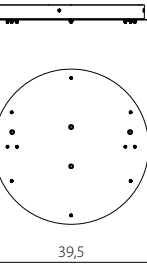
				kg	
		XM03401.552.0002 XM03402.552.0002 XM03417.552.0002 XM03419.552.0002 XM03430.552.0002	Rosone per alimentazione e sospensione di 1 modello Zero Shapes Horizontal e 1 modello Zero Round Vertical, con driver 60W/24V DALI/Push DIM.	Canopy for power supply and suspension of 1 Zero Shapes Horizontal and 1 Zero Round Vertical models, with 60W/24V DALI/Push DIM drivers.	4,12
		XM03401.553.0002 XM03402.553.0002 XM03417.553.0002 XM03419.553.0002 XM03430.553.0002	Rosone per alimentazione e sospensione di 2 modelli Zero Shapes Horizontal e 1 modello Zero Round Vertical, con n.2 driver 60W/24V DALI/Push DIM.	Canopy for power supply and suspension of 2 Zero Shapes Horizontal and 1 Zero Round Vertical models, with n.2 60W/24V DALI/Push DIM drivers.	4,32
		XM03401.554.0002 XM03402.554.0002 XM03417.554.0002 XM03419.554.0002 XM03430.554.0002	Rosone per alimentazione e sospensione di 2 modelli Zero Shapes Horizontal e 2 modelli Zero Round Vertical, con n.4 driver 60W/24V DALI/Push DIM.	Canopy for power supply and suspension of 2 Zero Shapes Horizontal and 2 Zero Round Vertical models, with n.4 driver 60W/24V DALI/Push DIM drivers.	4,6

Fotometrie disponibili www.panzeri.it / Photometric data available at www.panzeri.it

CODICI COLORI DISPONIBILI / COLOUR CODES AVAILABLE

01 bianco white	02 nero black	17 bronzo bronze	19 ottone satinato mat brass	30 titanio titanium
---------------------------	-------------------------	----------------------------	--	-------------------------------

MATRICE DI COMPATIBILITA' ROSONI/APPARECCHI ZERO SHAPES - CANOPIES/ZERO SHAPES FIXTURES MATRIX

NUMERO E TIPO DI APPARECCHI PER ROSONE / KIND AND FIXTURES NUMBER FOR CANOPY		
ROSONE/CANOPY	ZERO ROUND VERTICAL	ZERO ROUND (Ø 50 - 75 - 100) O/OR ZERO SQUARE O/OR ZERO ELLIPSE
XM033_.511.0002		1 (solo collegamento elettrico - power supply only)
XM033_.522.0002		2 (solo collegamento elettrico - power supply only)
XM033_.523.0002		3 (solo collegamento elettrico - power supply only)
XM033_.524.0002		4 (solo collegamento elettrico - power supply only)
XM033_.531.0002		1
XM033_.532.0002		2
XM033_.533.0002		3
XM033_.534.0002		4
XM034_.531.0002	1	
XM034_.533.0002	3	
XM034_.552.0002	1	1
XM034_.553.0002	1	2
XM034_.554.0002	2	2

ACUSTICA / ACOUSTIC

- 163 ARENA ACOUSTIC
- 170 PHI
- 167 ZERO ROUND ACOUSTIC



ARENA ACOUSTIC

Enzo Panzeri 2021



Sospensione fonoassorbente per illuminazione diretta, con driver integrato per regolazione dell'intensità luminosa tramite dispositivi DALI o Push DIM. Pannello fonoassorbente in PET con assorbimento acustico di Classe C che riduce fino al 70% del suono riverberato (NRC 0.7) e con classe di reazione al fuoco Classe 1 ISO 9705. La superficie fonoassorbente è inserita nello stesso profilo in alluminio di Arena, prestandosi ad originali composizioni di elementi acustici e lampade a sospensione delle famiglie Zero Shapes e Arena. Bianco, nero, bronzo, ottone satinato e titanio le finiture disponibili. Pannello in PET colore basalto, colori custom a richiesta.

Sound-absorbing suspension with downwards illumination, with integrated power supply for dimming the light intensity through DALI or Push DIM protocol. Acoustic PET panel with sound absorption Class C which reduces up to 70% of reverberated sound (NRC 0.7) and a Group 1 ISO 9705 fire rating. The sound-absorbing panel is inside the same aluminum profile as Arena, useful for compositions of acoustic elements and suspension lamps (Zero Shapes and Arena). White, black, titanium, bronze and mat brass finishes are available. Acoustic PET panel in basalt color, custom colors are available on request.

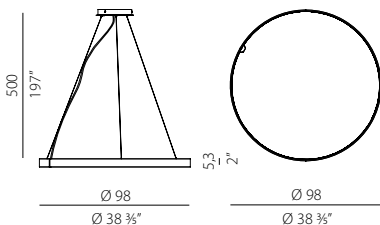

CODICE CODE	FONTI LUMINOSE LIGHT SOURCES	kg
L04601.100.0502	Potenza assorbita apparecchio / Luminaire power consumption 51W	5,80
L04602.100.0502	Flusso luminoso apparecchio / Luminaire luminous flux 1434lm	
L04617.100.0502	2700K Ra>90 220-240V AC dimmable (DALI/Push DIM)	
L04619.100.0502	IP20	
L04630.100.0502		

Fotometrie disponibili www.panzeri.it / Photometric data available at www.panzeri.it

UGR<19 in funzione delle condizioni di installazione / UGR<19 depending on installation conditions

CODICI COLORI DISPONIBILI / COLOUR CODES AVAILABLE

- 01** bianco white
- 02** nero black
- 17** bronzo bronze
- 19** ottone satinato mat brass
- 30** titanio titanium



slalom[®]
acoustic & partition systems

- L05601.100.0502**
- L05602.100.0502**
- L05617.100.0502**
- L05619.100.0502**
- L05630.100.0502**

Panel by Slalom

Potenza assorbita apparecchio / Luminaire power consumption 51W	kg
Flusso luminoso apparecchio / Luminaire luminous flux 1434lm	5,80
2700K Ra>90 220-240V AC dimmable (DALI/Push DIM)	
IP20	

Pannello fonoassorbente by Slalom
Struttura bianca 01, pannello "natural grey"
Struttura nera 02, pannello "morning green"
Struttura bronzo 17, pannello "brick"
Struttura ottone satinato 19, pannello "milk"
Struttura titanio 30, pannello "mud"

Sound-absorbing panel by Slalom
White 01 structure, "natural grey" panel
Black 02 structure, "morning green" panel
Bronze 17 structure, "brick" panel
Mat brass 19 structure, "milk" panel
Titanium 30 structure, "mud" panel

Il pannello fonoassorbente "MILLERIGHE" con rivestimento "PETfelt", realizzato con il materiale ricavato dal riciclo di bottiglie di plastica, o "PETfabric", in poliestere riciclato, offre un elevato comfort acustico, resistenza al fuoco ed idoneo per le certificazioni architettoniche di edifici Breeam, Leed, Well e Fitwel.

Sound-absorbing panel "MILLERIGHE" with "PETfelt" finish, made with the material obtained from the recycling of plastic bottles, or "PETfabric", recycled polyester, offers high acoustic comfort, fire resistance and is suitable for Breeam, Leed, Well and Fitwel building certifications.

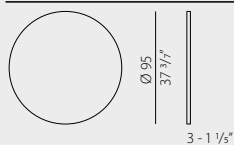

YPA05602.030

NOVELTY

Pannello fonoassorbente per aumento prestazione acustica [coefficiente Alpha W (aw) 0,9]. Altezza finale apparecchio 6,5cm (2 5/9")

Sound absorbing panel for increased acoustic performance [Alpha W coefficient (aw) 0.9]. Fixture total height 6,5cm (2 5/9")

Fotometrie disponibili www.panzeri.it / Photometric data available at www.panzeri.it

UGR<19 in funzione delle condizioni di installazione / UGR<19 depending on installation conditions

CODICI COLORI DISPONIBILI / COLOUR CODES AVAILABLE

Finitura / Finishes **YPA05602.038**

- 01** bianco / natural grey white / natural grey
- 02** nero / morning green white / morning green
- 17** bronzo / brick bronze / brick
- 19** ottone satinato / milk mat brass / milk
- 30** titanio / mud titan / mud
- 02** nero black









slalom[®]

acoustic & partition systems



Struttura bianca 01
pannello "natural grey"

White 01 structure
"natural grey" panel



Struttura nera 02
pannello "morning green"

Black 02 structure
"morning green" panel

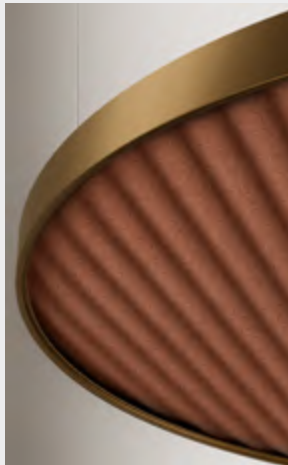

Struttura bronzo 17
pannello "brick"

Bronze 17 structure
"brick" panel



Struttura ottone satinato 19
pannello "milk"

Mat brass 19 structure
"milk" panel

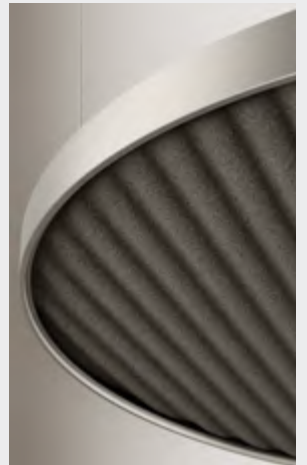

Struttura titanio 30
pannello "mud"

Titanium 30 structure
"mud" panel



ZERO ROUND ACOUSTIC

Enzo Panzeri 2020



Pannello fonoassorbente a sospensione in PET con assorbimento acustico di Classe C che riduce fino al 70% del suono riverberato (NRC 0.7) e con classe di reazione al fuoco Classe 1 ISO 9705. La superficie fonoassorbente è inserita nello stesso profilo in alluminio di Zero Round, prestandosi ad originali composizioni di elementi privi di sorgente luminosa (Zero Round Acoustic) e lampade a sospensione (Zero Round e Arena). Bianco, nero, titanio, bronzo e ottone satinato le finiture disponibili. Pannello in PET colore basalto, colori custom a richiesta.

Acoustic PET panel with sound absorption Class C which reduces up to 70% of reverberated sound (NRC0.7) and a Group 1 ISO 9705 fire rating. The sound-absorbing panel is inside the same aluminium profile as Zero Round, useful for compositions of elements without light source (Zero Round Acoustic) and suspension lamps (Zero Round and Arena). White, black, titanium, bronze and mat brass finishes are available. Acoustic PET panel in basalt color, custom colors are available on request.

CODICE CODE	kg
-------------	----

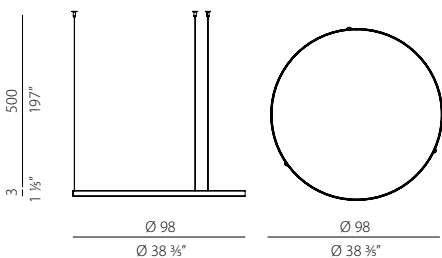

L04501.100.0099	3,33
L04502.100.0099	
L04517.100.0099	
L04519.100.0099	
L04530.100.0099	

CODICI COLORI DISPONIBILI / COLOUR CODES AVAILABLE

01 bianco white	02 nero black	17 bronzo bronze	19 ottone satinato mat brass	30 titanio titanium

slalom®

acoustic & partition systems

L05501.100.0099
L05502.100.0099
L05517.100.0099
L05519.100.0099
L05530.100.0099

Panel by Slalom

kg
3,33

Pannello fonoassorbente by Slalom
Struttura bianca 01, pannello "natural grey"
Struttura nera 02, pannello "morning green"
Struttura bronzo 17, pannello "brick"
Struttura ottone satinato 19, pannello "milk"
Struttura titanio 30, pannello "mud"

Sound-absorbing panel by Slalom
White 01 structure, "natural grey" panel
Black 02 structure, "morning green" panel
Bronze 17 structure, "brick" panel
Mat brass 19 structure, "milk" panel
Titanium 30 structure, "mud" panel

Il pannello fonoassorbente "MILLERIGHE" con rivestimento "PETfelt", realizzato con il materiale ricavato dal riciclo di bottiglie di plastica, o "PETfabric", in poliestere riciclato, offre un elevato comfort acustico, resistenza al fuoco ed idoneo per le certificazioni architettoniche di edifici Breeam, Leed, Well e Fitwel.

Sound-absorbing panel "MILLERIGHE" with "PETfelt" finish, made with the material obtained from the recycling of plastic bottles, or "PETfabric", recycled polyester, offers high acoustic comfort, fire resistance and is suitable for Breeam, Leed, Well and Fitwel building certifications.



RECYCLED PLASTIC



ECO FRIENDLY



100% RECYCLABLE



LOW EMISSIONS



100% TRACEABLE SOURCES



MADE IN ITALY

CODICI COLORI DISPONIBILI / COLOUR CODES AVAILABLE

01 bianco / natural grey white / natural grey	02 nero / morning green white / morning green	17 bronzo / brick bronze / brick	19 ottone satinato / milk mat brass / milk	30 titanio / mud titan / mud







Sospensione fonoassorbente per illuminazione diretta, con driver integrato. Il paralume fonoassorbente by Slalom è composto al 75% da materiale plastico riciclato, rivestito da un sottile strato di feltro sempre riciclato al 96% e accoglie una piccola elemento luminoso circolare in alluminio pressofuso con sorgente luminosa LED. Disponibile in finiture bianco, nero e ottone satinato con paralume "milk" e in finiture bronzo e titanio con paralume "mud". Adatto a garantire il giusto comfort visivo e acustico negli spazi in cui viene collocata, principalmente ristoranti, aree comuni e spazi commerciali.

Sound-absorbing suspension lamp for direct lighting, with integrated driver. The sound-absorbing lampshade by Slalom is composed of 75% recycled plastic material, covered with a thin layer of felt, also 96% recycled, and houses a small circular die-casted aluminium light element with LED light source. Available in white, black and mat brass finishes with 'milk' lampshade and in bronze and titanium finishes with 'mud' lampshade. Suitable for ensuring the right visual and acoustic comfort in the spaces where it is placed, mainly restaurants, public areas and commercial spaces.

NOVELTY	CODICE CODE	FONTI LUMINOSE LIGHT SOURCES	kg
---------	-------------	------------------------------	----



- L05801.060.0501**
- L05802.060.0501**
- L05817.060.0501**
- L05819.060.0501**
- L05830.060.0501**

Potenza assorbita apparecchio / Luminaire power consumption 8,5W
 Flusso luminoso apparecchio / Luminaire luminous flux 422lm
 2700K Ra>90 220-240V AC ON-OFF

IP40

Struttura bianca 01, nera 02, ottone satinato 19: paralume fonoassorbente "milk".
 Struttura bronzo 17, titanio 30: paralume fonoassorbente "mud"
 White 01, black 02, mat brass 19 structure: sound-absorbing lampshade "milk"
 Bronze 17, titanium 30 structure: sound-absorbing lampshade "mud"

slalom[®]
 acoustic & partition systems

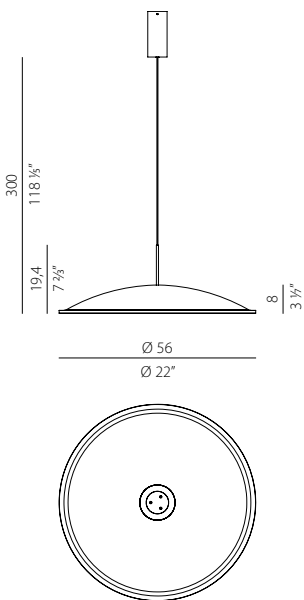

Fotometrie disponibili www.panzeri.it / Photometric data available at www.panzeri.it

CODICI COLORI DISPONIBILI / COLOUR CODES AVAILABLE

- | | | | | |
|---------------------------|-------------------------|--|----------------------------|-------------------------------|
| 01 bianco
white | 02 nero
black | 19 ottone satinato
mat brass | 17 bronzo
bronze | 30 titanio
titanium |
|---------------------------|-------------------------|--|----------------------------|-------------------------------|

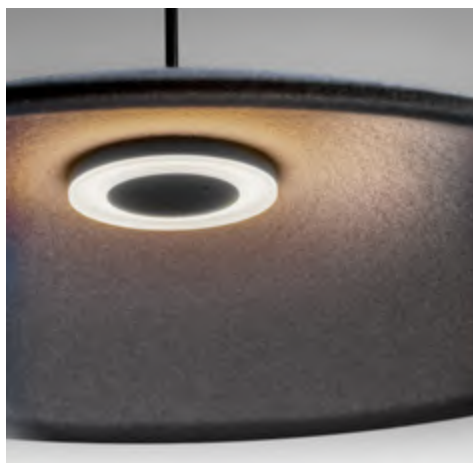

DECENTRAMENTI / OFFSET



Elementi per il fissaggio di funi di sospensione e cavi di alimentazione per creare composizioni di apparecchi personalizzate.

Elements for fixing suspension ropes and power cables to create customized luminaires configurations.

CODICE
CODE

kg



2
4/8"

3,4
1 1/8"

M79D

0,03

Dispositivo di sospensione e regolazione per fune in acciaio.

Suspension and adjustment device for steel cable.

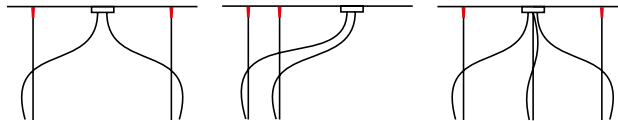

2,9
1 1/8"

4,2
1 3/8"

M75D

0,02

Dispositivo di sospensione e regolazione per cavo elettrico.

Suspension and adjustment device for electric cable.

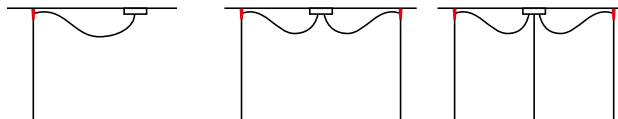

2
4/8"

3,2
1 1/4"

M800

0,01

Appendimento in policarbonato per sospensione.

Polycarbonate hook for suspension.

CODICI COLORI DISPONIBILI / COLOUR CODES AVAILABLE

01 bianco
white

ROSONI PER DECENTRAMENTO / CANOPIES FOR OFFSET



NOVELTY

Rosoni per composizioni di apparecchi d'illuminazione a tensione di rete.

Canopies for configurations of mains voltage lighting fixtures.

CODICE
CODE

kg

M7901/1

0,13

M7902/1

Rosone per collegamento elettrico.

Canopy for power supply.

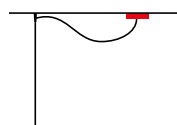
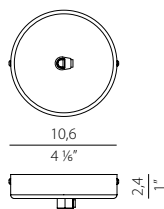

M7901/2

0,02

M7902/2

Rosone per collegamento elettrico con 2 uscite.

Canopy for power supply with 2 outputs.

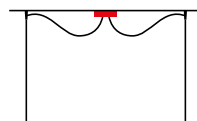
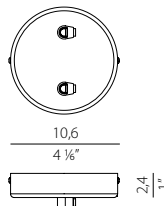

M7901/3

0,01

M7902/3

Rosone per collegamento elettrico con 3 uscite.

Canopy for power supply with 3 outputs.

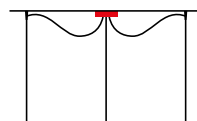
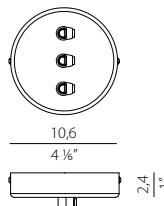

CODICI COLORI DISPONIBILI / COLOUR CODES AVAILABLE

01 bianco
white

02 nero
black

ROSONI CON ALIMENTATORE / CANOPIES WITH DRIVER



Rosoni per composizioni di apparecchi d'illuminazione a bassissima tensione 24V.

Canopies for configurations of low voltage 24V lighting fixtures.

CODICE
CODE

kg

XM8901-03 LED

1,17

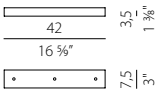

Rosone per alimentazione e sospensione di massimo 3 modelli a tensione costante 24V DC.

Canopy for power supply and suspension up to 3 24V DC constant voltage models maximum.

XM8901-05 LED

1,78

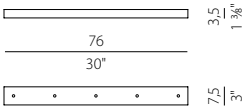

Rosone per alimentazione e sospensione di massimo 5 modelli a tensione costante 24V DC.

Canopy for power supply and suspension up to 5 24V DC constant voltage models maximum.

XM8901-06 LED

2,13

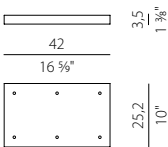

Rosone per alimentazione e sospensione di massimo 6 modelli a tensione costante 24V DC.

Canopy for power supply and suspension up to 6 24V DC constant voltage models maximum.

CODICI COLORI DISPONIBILI / COLOUR CODES AVAILABLE

01 bianco
white

MATRICE DI COMPATIBILITA' ROSONI/APPARECCHI A SOSPENSIONE / CANOPIES/SUSPENDED FIXTURES MATRIX

NUMERO E TIPO DI APPARECCHI PER ROSONE / KIND AND FIXTURES NUMBER FOR CANOPY		
ROSONE/CANOPY	Candle, Olivia, Emma&Clio, Ely, Emy, Evy (220V-240V)	Bella, Candle, Muranè, To-be (24V)
XM8901-03	3	
XM8901-03 LED		3
XM8901-05	5	
XM8901-05 LED		5
XM8901-06	6	
XM8901-06 LED		6
XM8901-09	9	driver 24V non installato a richiesta / 24V driver not installed on request
XM8901-15	15	driver 24V non installato a richiesta / 24V driver not installed on request
XM9001-03	3	driver 24V non installato a richiesta / 24V driver not installed on request
XM9001-07	7	driver 24V non installato a richiesta / 24V driver not installed on request
XM9001-12	12	driver 24V non installato a richiesta / 24V driver not installed on request
XM9001-21	21	driver 24V non installato a richiesta / 24V driver not installed on request
XM9201-01	1	prevedere driver 24V remoto/remote driver 24V needed

Verificare eventuali interferenze tra gli apparecchi installati / Check for any interference between the installed fixtures

L'Ufficio Tecnico Panzeri è disponibile a supporto della progettazione / Panzeri Technical Department is available to support the design

ROSONI PER FISSAGGIO MULTIPLO / CANOPIES FOR MULTIPLE FIXING



Rosoni per composizioni di apparecchi d'illuminazione a tensione di rete o a bassissima tensione 24V con l'aggiunta di idoneo driver.

Canopies for configurations of mains voltage lighting fixtures or low voltage 24V lighting fixtures with a suitable driver.

	CODICE CODE	kg
<p>Rosone per collegamento elettrico con 3 uscite.</p>	XM8901-03	0,95
<p>Rosone per collegamento elettrico con 5 uscite.</p>	XM8901-05	1,58
<p>Rosone per collegamento elettrico con 6 uscite.</p>	XM8901-06	1,79
<p>Rosone per collegamento elettrico con 9 uscite.</p>	XM8901-09	6,01
<p>Rosone per collegamento elettrico con 15 uscite.</p>	XM8901-15	5,75

	CODICE CODE	kg
<p>Rosone per collegamento elettrico con 3 uscite.</p>	XM9001-03	3
<p>Rosone per collegamento elettrico con 5 uscite.</p>	XM9001-07	2,97
<p>Rosone per collegamento elettrico con 7 uscite.</p>	XM9001-12	7,11
<p>Rosone per collegamento elettrico con 12 uscite.</p>	XM9001-21	14,6
<p>Rosone per collegamento elettrico con 21 uscite.</p>		

CODICI COLORI DISPONIBILI / COLOUR CODES AVAILABLE

01 bianco
white

ROSONI A SCOMPARSA / RECESSED CANOPIES



Rosone a scomparsa per sospensioni con solo cavo elettrico.

Recessed canopy for electric cable suspensions.

CODICE
CODE

kg

XM9201-01

Rosone a scomparsa per sospensioni con solo cavo elettrico, utilizzabile per tutti gli apparecchi a 24V prevedendo driver remoto.

Recessed canopy for electric cable suspensions. Suitable for 24V fixtures: remote driver 24V needed.

0,13

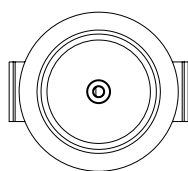

8

3 1/2"

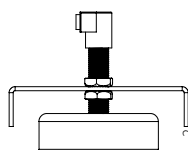

7

2 3/8"

4 1/8"

2"

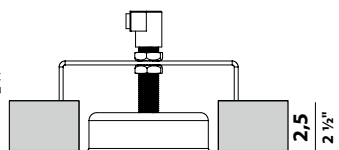

2,5

2 1/2"



∅ 6,5

∅ 2 3/8"

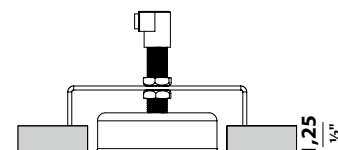

1,25

1/2"

CODICI COLORI DISPONIBILI / COLOUR CODES AVAILABLE

01 bianco
white

ESTERNO / OUTDOOR

178 FIREFLY in the sky

177 FOUR

182 POTTER

183 RALPH

188 VENEXIA



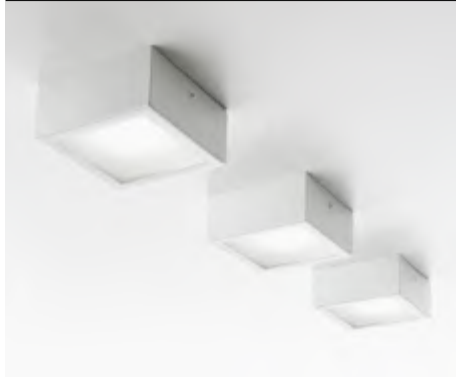

FOUR

Officina Panzeri 2011



Lampada LED da parete/soffitto IP44 in fusione di alluminio e fronte in acciaio MARINO AISI 314 verniciato marrone metallizzato o bianco con vetro frontale.

LED wall/ceiling lamp IP44 in aluminium casting. Brown metallized or white stainless MARINE AISI 314 and mat glass.

CODICE CODE		FONTI LUMINOSE LIGHT SOURCES	kg
	EP04401.000.0406	Potenza assorbita apparecchio / Luminaire power consumption 10W	0,69
	EP04444.000.0406	Flusso luminoso apparecchio / Luminaire luminous flux 595lm 3000K Ra>90 220-240V AC ON-OFF	
		 IP44	

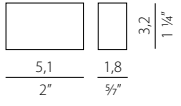
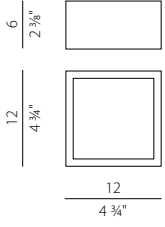

XM14/230

Dispositivo dimmerabile per moduli LED a 230V, 5÷100W.
Dimmable device for 230V LED modules, 5÷100W.

Fotometrie disponibili www.panzeri.it / Photometric data available at www.panzeri.it

CODICI COLORI DISPONIBILI / COLOUR CODES AVAILABLE

- 01** bianco / white
- 44** marrone metallizzato / metallized brown

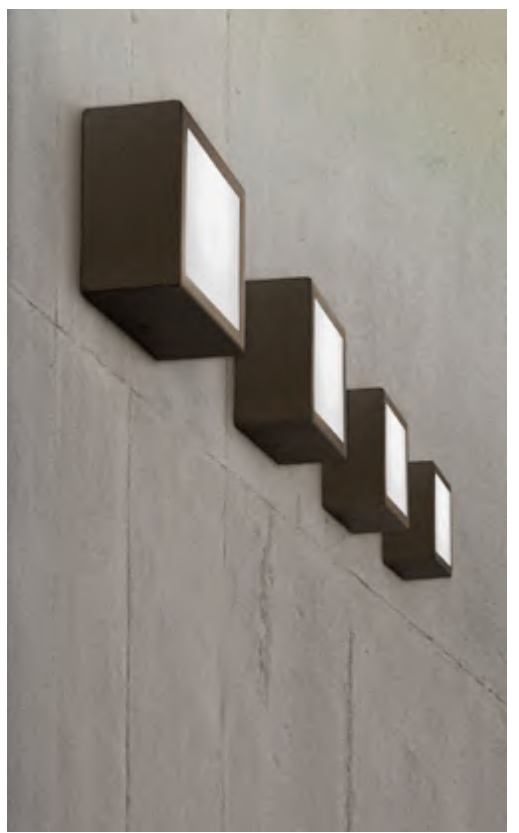



FIREFLY IN THE SKY

Matteo Thun 2019

Registered Design



Firefly in the sky è un apparecchio a batteria da tavolo. La testa removibile racchiude sistema di aggancio magnetico, batteria ricaricabile tramite USB-C, sorgente LED e comando Step DIM a 5 regolazioni di intensità luminosa. In funzione delle condizioni di utilizzo per una ricarica di circa 4 ore si stima un'autonomia di circa 6 ore con intensità della luce al 100% e di circa 24 ore con intensità della luce al 25%. Base antiscivolo già in dotazione. Verde oliva materico, bianco soft materico, terracotta naturale materico e corten si aggiungono alle finiture disponibili nero satinato, bronzo e champagne.

Firefly in the sky is a battery table lamp. The removable head contains magnetic coupling system, rechargeable battery via USB-C, LED source and Step DIM control with 5 light intensity settings. Depending on the conditions of use for a recharge of approximately 4 hours, an autonomy of approximately 6 hours is estimated with 100% light intensity and approximately 24 hours with 25% light intensity. Anti-slip base included. Textured olive green, textured soft white, textured natural terracotta and corten are added to mat black, bronze and champagne finishes available.

	CODICE CODE	FONTI LUMINOSE LIGHT SOURCES	kg
	C07805.011.0514	Potenza assorbita apparecchio / Luminaire power consumption 2W	1,06
	C07806.011.0514	Flusso luminoso apparecchio / Luminaire luminous flux 134lm	
	C07816.011.0514	2700K Ra>90 5V DC battery Dimmable (Step DIM)	
	C07817.011.0514	IP65	
	C07827.011.0514	Interruttore incluso / Switch included	
	C07828.011.0514 C07829.011.0514	In funzione delle condizioni di utilizzo per una ricarica di circa 4 ore si stima un'autonomia di circa 6 ore con intensità della luce al 100% e di circa 24 ore con intensità della luce al 25%. Indicatore LED per lo stato di carica. La carica avviene tramite USB-C. Caricabatteria e cavetto inclusi.	
		Depending on the conditions of use for a recharge of approximately 4 hours, an autonomy of approximately 6 hours is estimated with 100% light intensity and approximately 24 hours with 25% light intensity. LED indicator for the load status. Charging takes place via USB-C. Battery charger and cable Included.	

	PE07805.011.0514	Potenza assorbita apparecchio / Luminaire power consumption 2W	0,91
	PE07806.011.0514	Flusso luminoso apparecchio / Luminaire luminous flux 134lm	
	PE07816.011.0514	2700K Ra>90 5V DC battery Dimmable (Step DIM)	
	PE07817.011.0514	IP65	
	PE07827.011.0514 PE07828.011.0514 PE07829.011.0514	Fornito completo di picchetto di fissaggio al suolo, interruttore incluso Supplied with peg to fix to the ground, switch included	
		In funzione delle condizioni di utilizzo per una ricarica di circa 4 ore si stima un'autonomia di circa 6 ore con intensità della luce al 100% e di circa 24 ore con intensità della luce al 25%. Indicatore LED per lo stato di carica. La carica avviene tramite USB-C. Caricabatteria e cavetto inclusi.	
		Depending on the conditions of use for a recharge of approximately 4 hours, an autonomy of approximately 6 hours is estimated with 100% light intensity and approximately 24 hours with 25% light intensity. LED indicator for the load status. Charging takes place via USB-C. Battery charger and cable Included.	



reddot winner 2020

FIREFLY IN THE SKY

Matteo Thun 2019

Registered Design

	CODICE CODE	FONTI LUMINOSE LIGHT SOURCES	kg
NOVELTY	YRM07802_010	Vassoio per ricarica multipla di massimo 10 modelli Firefly in the Sky. Multiple charging tray for up to 10 Firefly in the Sky models.	4,03

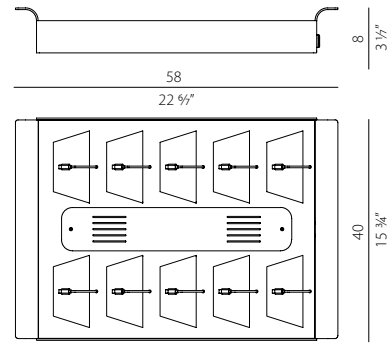

Fotometrie disponibili www.panzeri.it / Photometric data available at www.panzeri.it

CODICI COLORI DISPONIBILI / COLOUR CODES AVAILABLE

- | | | | | | | | |
|-------------------------------|-----------------------------------|-------------------------|-------------------------|---|--|--|----------------------|
| 05 champagne champagne | 06 nero satinato mat black | 16 corten corten | 17 bronzo bronzo | 27 verde oliva materico textured olive green | 28 bianco soft materico textured soft white | 29 terracotta naturale materico textured natural terracotta | 02 nero black |
|-------------------------------|-----------------------------------|-------------------------|-------------------------|---|--|--|----------------------|









POTTER

Valerio Bottin - Enzo Panzeri 2011

Registered Design



Lampada da esterno in polietilene bianco, utilizzabile come seduta.

Illuminated outside stool in white polyethylene.

	CODICE CODE	FONTI LUMINOSE LIGHT SOURCES	kg
	ET04201.000.0000	LED retrofit bulb E27 (L max 140mm - Ø max 65mm) max 70W E27 IP65	6,24
	M42	Picchetto per il fissaggio al suolo. Portata max 130kg Peg for ground fixing. Maximum load 130kg	0,36

Fotometrie disponibili www.panzeri.it / Photometric data available at www.panzeri.it

CODICI COLORI DISPONIBILI / COLOUR CODES AVAILABLE

01 bianco
white





Lampada a sospensione, tavolo, terra e picchetto studiata per esterni. Paralume in rattan sintetico intrecciato a mano colore marrone e stelo in alluminio/ottone (versione da tavolo, terra e picchetto). Diffusore in policarbonato trasparente con portalampada E27. Diffusore con attacco a baionetta studiato per permettere una facile rimozione per l'eventuale ritiro del paralume durante l'inverno. Versione a sospensione fornita con 1 cavo di alimentazione in color arancione (versione da 90 equipaggiata anche con 1 cavo di sospensione in acciaio). Disponibili accessori per fissaggio a parete. Ideale per zone living esterne o illuminazione di giardini.

Outdoor lamp in the suspension, table, floor and peg versions. Lampshade in hand-woven synthetic brown rattan and body in aluminium/brass (table, floor and peg versions). Transparent polycarbonate diffuser with E27 lamp socket. Diffuser with bayonet fitting, designed for an easy removal of the lampshade during the winter. Suspended version supplied with 1 power cable in orange (version 90 also equipped with 1 suspension steel cable). Available accessories for wall fixing. Ideal for outdoor living areas or garden lighting.

CODICE CODE	FONTI LUMINOSE LIGHT SOURCES	kg
-------------	------------------------------	----

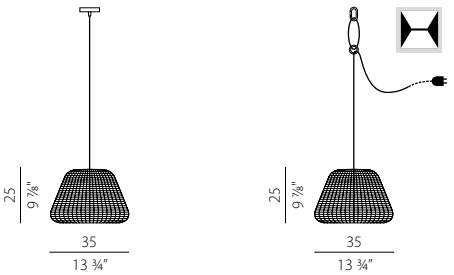

EL04744.035.0000

LED retrofit bulb E27 (L max 125mm - Ø max 65mm)
max 53W E27

2,49

IP65

Fornito completo di cavo di collegamento 4,5m, spina, rosone, o-ring in silicone, moschettone. IP65 solo versione con spina
Supplied with 4,5m cable, plug, canopy, silicone o-ring, hook. IP65 only plug version

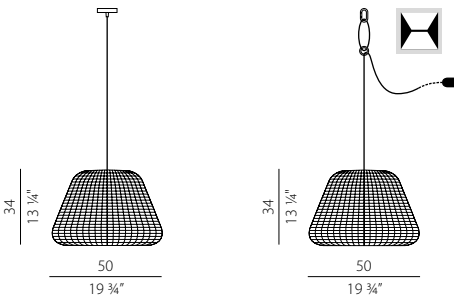

EL04744.050.0000

LED retrofit bulb E27 (L max 125mm - Ø max 65mm)
max 53W E27

4,16

IP65

Fornito completo di cavo di collegamento 4,5m, spina, rosone, o-ring in silicone, moschettone. IP65 solo versione con spina
Supplied with 4,5m cable, plug, canopy, silicone o-ring, hook. IP65 only plug version

Versione con rosone IP20
Canopy version IP20

Versione con O-Ring IP65
O-Ring version IP65

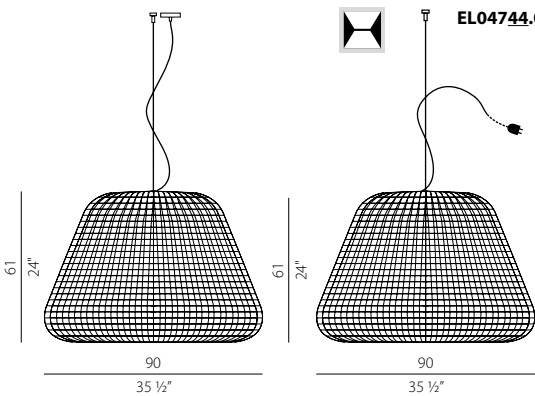

EL04744.090.0000

LED retrofit bulb E27 (L max 125mm - Ø max 65mm)
max 53W E27

11,37

IP65

Fornito completo di cavo di collegamento 4,5m, spina e rosone. IP65 solo versione con spina
Supplied with 4,5m cable, plug and canopy. IP65 only plug version

Versione con rosone IP20
Canopy version IP20

Versione con spina IP65
Version plug IP65

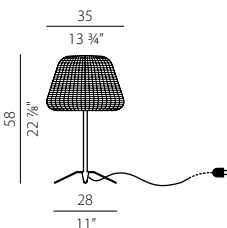

EC04744.035.0000

LED retrofit bulb E27 (L max 125mm - Ø max 65mm)
max 53W E27







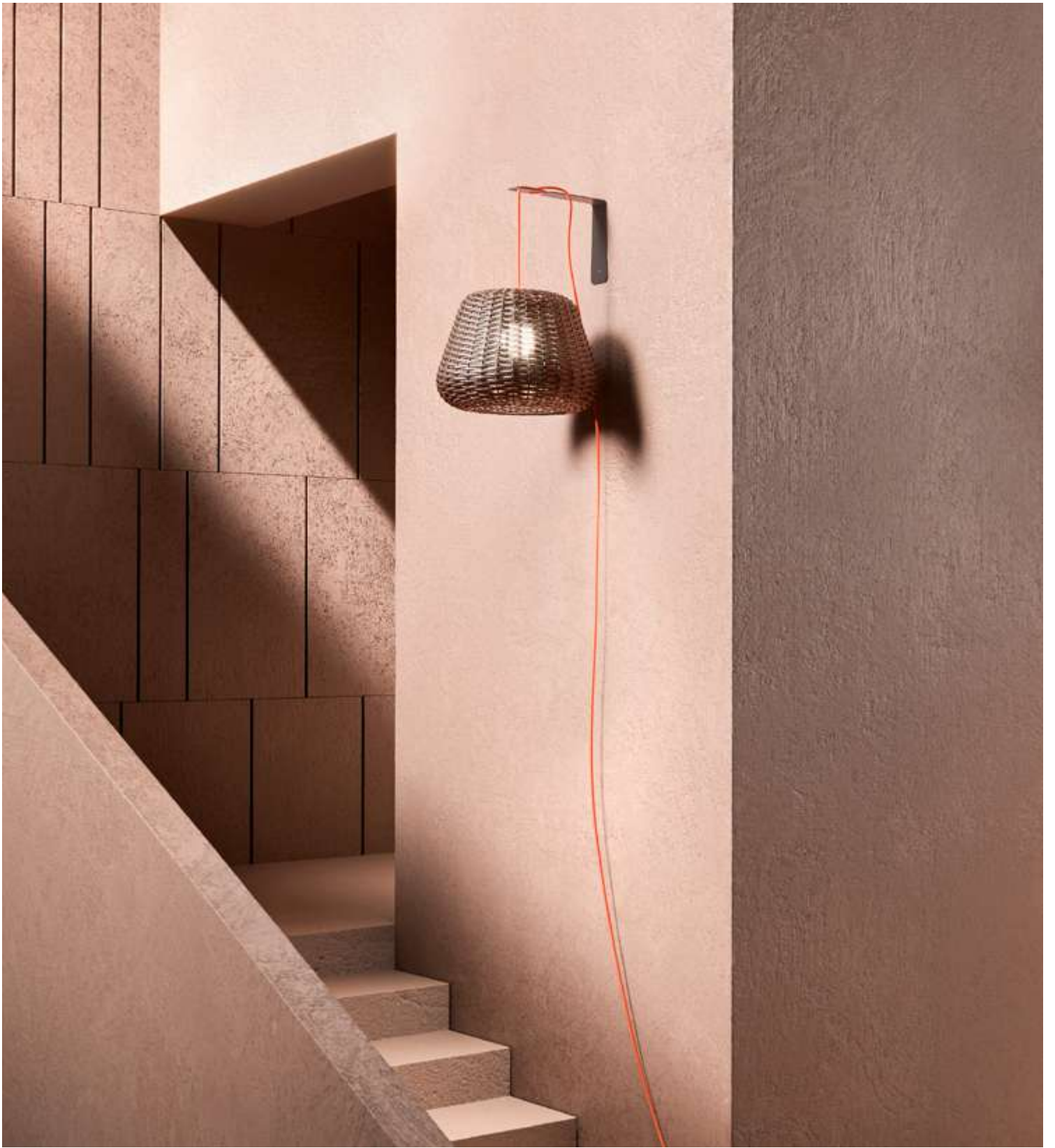

3,36

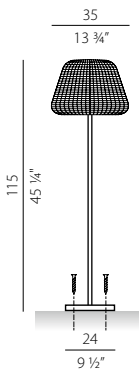
IP65

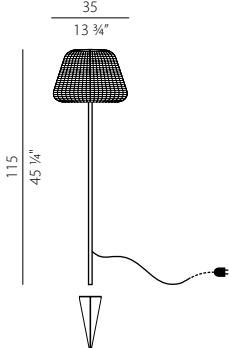
Fornito con interruttore
Supplied with switch

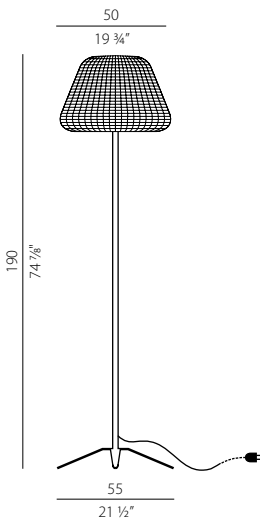

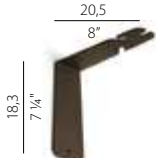

	CODICE CODE	FONTI LUMINOSE LIGHT SOURCES	kg
 <p>35 13 3/4"</p> <p>115 45 1/4"</p> <p>24 9 1/2"</p>	ET04744.035.0000	LED retrofit bulb E27 (L max 125mm - Ø max 65mm) max 53W E27 IP65  Fornito completo di base. Da fissare al suolo Supplied complete with base. To be fixed to the ground	3,42
 <p>35 13 3/4"</p> <p>115 45 1/4"</p>	PE04744.035.0000	LED retrofit bulb E27 (L max 125mm - Ø max 65mm) max 53W E27 IP65  Fornito completo di picchetto di fissaggio al suolo, spina e interruttore Supplied with peg to fix to the ground, plug and switch	3,84
 <p>50 19 3/4"</p> <p>190 74 7/8"</p> <p>55 21 1/2"</p>	ET04744.050.0000	LED retrofit bulb E27 (L max 125mm - Ø max 65mm) max 53W E27 IP65  Fornito completo di base, interruttore e spina Supply with base, switch and plug	9,25
 <p>20,5 8"</p> <p>18,3 7 1/4"</p>	M4744 A	Staffa per fissaggio a parete in alluminio plastificato. Accessorio per EL047__035.0000 Wall fixing bracket in plasticised aluminium. Accessory for EL047__035.0000	0,59
	M47 T	Picchetto per il fissaggio al suolo per ET047__050.0000. Peg for ground fixing for ET047__050.0000.	0,87

Fotometrie disponibili www.panzeri.it / Photometric data available at www.panzeri.it

CODICI COLORI DISPONIBILI / COLOUR CODES AVAILABLE

44 marrone metallizzato
metallized brown

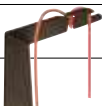

paralume marrone
lampshade brown







Lampada a sospensione, parete e paletto per esterni IP65 con testa in vetro colato e piattello in alluminio tornito. Paletto in alluminio disponibile in tre altezze, completo di sistema di fissaggio per installazione a terra. Versione parete con braccio rigido di fissaggio a parete. Finiture grigio micaceo, legno verniciato con accessori in ottone satinato, corten. Ideale per hotel, ristoranti, residenze.

Suspension, wall lamp and bollard for outdoor IP65 with cast glass head and turned aluminium plate. Bollard available in three heights, complete with fixing system for ground installation. Wall version with fixed wall arm. Micaceous grey, varnished wood with mat brass accessories and corten finishes are available. Ideal for hotels, restaurants, residences.

	CODICE CODE	FONTI LUMINOSE LIGHT SOURCES	kg
	ET04816.045.0201 ET04834.045.0201 ET04845.045.0201	Potenza assorbita apparecchio / Luminaire power consumption 8W Flusso luminoso apparecchio / Luminaire luminous flux 594lm 2700K Ra>80 220-240V AC ON-OFF IP65	3,43
	ET04816.070.0201 ET04834.070.0201 ET04845.070.0201	Potenza assorbita apparecchio / Luminaire power consumption 8W Flusso luminoso apparecchio / Luminaire luminous flux 594lm 2700K Ra>80 220-240V AC ON-OFF IP65	3,70
	ET04816.095.0201 ET04834.095.0201 ET04845.095.0201	Potenza assorbita apparecchio / Luminaire power consumption 8W Flusso luminoso apparecchio / Luminaire luminous flux 594lm 2700K Ra>80 220-240V AC ON-OFF IP65	3,82
	YTF04800.012	Tirafondi per il fissaggio al suolo. Anchor bolts for ground fixing.	0,22





VENEXIA

Matteo Thun 2020

	CODICE CODE	FONTI LUMINOSE LIGHT SOURCES	kg
	EL04816.022.0201	Potenza assorbita apparecchio / Luminaire power consumption 8W	3,40
	EL04819.022.0201	Flusso luminoso apparecchio / Luminaire luminous flux 594lm	
	EL04834.022.0201	2700K Ra>80 220-240V AC ON-OFF LED IP65 IK06	
	EA04816.022.0201	Potenza assorbita apparecchio / Luminaire power consumption 8W	3,60
	EA04819.022.0201	Flusso luminoso apparecchio / Luminaire luminous flux 594lm	
	EA04834.022.0201	2700K Ra>80 220-240V AC ON-OFF LED IP65 IK06	

Fotometrie disponibili www.panzeri.it / Photometric data available at www.panzeri.it

CODICI COLORI DISPONIBILI / COLOUR CODES AVAILABLE

16 corten
corten

34 grigio micaceo
micaceous grey

45 legno/ottone satinato
wood/mat brass

19 ottone satinato
mat brass



archiproducts
DESIGN AWARDS
—
WINNER 2020



PROFILI / PROFILES

230	BROADWAY
193	BRONX
198	BROOKLYN
198	BROOKLYN OUT
196	BROOKLYN ROUND
203	BROOKLYN SPOT
198	BROOKLYN TRIM
204	CORNER
207	GIANO
212	HARLEM
214	KIPS
213	KIPS ROUND
216	MANHATTAN
220	NOLITA
220	NOLITA OUT
220	NOLITA TRIM
231	NOOK
232	TRIBECA



BRONX XG247

XG247_+_LED+XM247_._202.0099

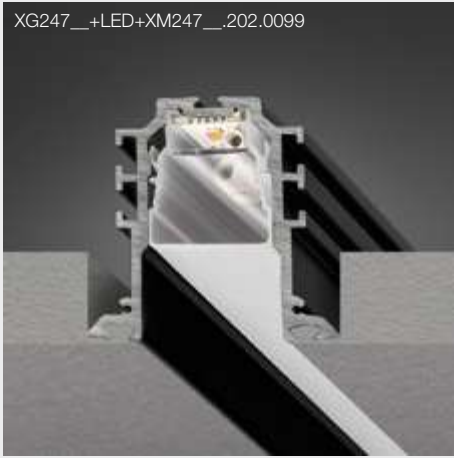

Profilo in alluminio estruso ad incasso, completo di diffusore in policarbonato estruso, studiato per consentire l'installazione su pannelli in cartongesso di diverso spessore (12,5mm e 25mm), grazie alla possibilità di posizionare gli elementi di fissaggio su due livelli. La sorgente luminosa è inserita a scorrimento senza incollaggio all'interno del diffusore in policarbonato estruso rimovibile a scatto, permettendo una semplice installazione.

Bronx is a recessed aluminium profile, characterized by the recessed positioning of the light source, and by a thin line of light of only 29 mm. The extrusion is designed to allow installation both on standard plasterboard panels and on panels with double thickness, thanks to the possibility of positioning the fixing tabs on two different levels. The light source is sliding inside the extruded polycarbonate diffuser without gluing, removable by snap, allowing a simple installation.

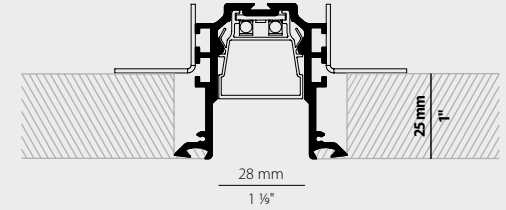
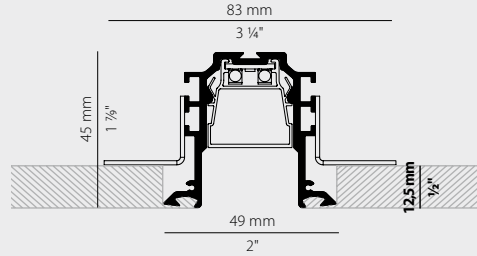

Electric options only with remote components page 303

Dimming / Power supply 303/304

Technical information 305

Wiring diagram 1 305

UGR <19 depending on installation conditions

Photometric data available at www.panzeri.it

TRIMLESS PROFILE

	CODICE / CODE	L MM	L INCHES	NR. ADVISED	MM	INCHES	kg				
Fornito completo di schermo diffusore	XG24701.050.0099	510	20"	2	515 x 50	20 7/8" x 2"	0,46				
Supplied with diffuser	XG24702.050.0099	510	20"	2	515 x 50	20 7/8" x 2"	0,46				
	XG24701.100.0099	1010	39 4/8"	2	1015 x 50	40" x 2"	0,88				
	XG24702.100.0099	1010	39 4/8"	2	1015 x 50	40" x 2"	0,88				
	XG24701.200.0099	2010	79 1/8"	3	2015 x 50	79 3/8" x 2"	1,74				
	XG24702.200.0099	2010	79 1/8"	3	2015 x 50	79 3/8" x 2"	1,74				
	XG24701.300.0099	3010	118 3/8"	4	3015 x 50	118 4/8" x 2"	2,61				
	XG24702.300.0099	3010	118 3/8"	4	3015 x 50	118 4/8" x 2"	2,61				

LED MODULE

	CODICE / CODE	L MM	L INCHES	MM	INCHES	W	LM	LM/M	NR. LED	LED	V
	XM005.050.0410	500	19 2/8"	62,5	2 1/2"	8,6W	1140lm	2280lm/m	64	3000K Ra>90	24V DC
	XM005.012.0410	125	5"	62,5	2 1/2"	2,15W	285lm	2280lm/m	16	3000K Ra>90	24V DC

Matrice di compatibilità LED / Profili pag. 233 / LED Profile Matrix page 233

CODICI COLORI DISPONIBILI / COLOUR CODES AVAILABLE

01 bianco
white

02 nero
black

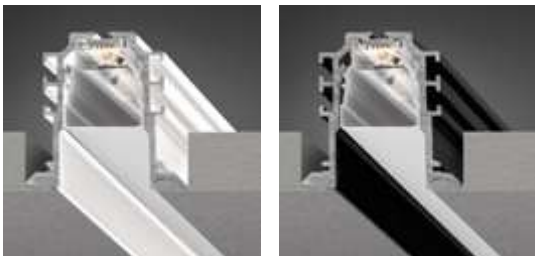

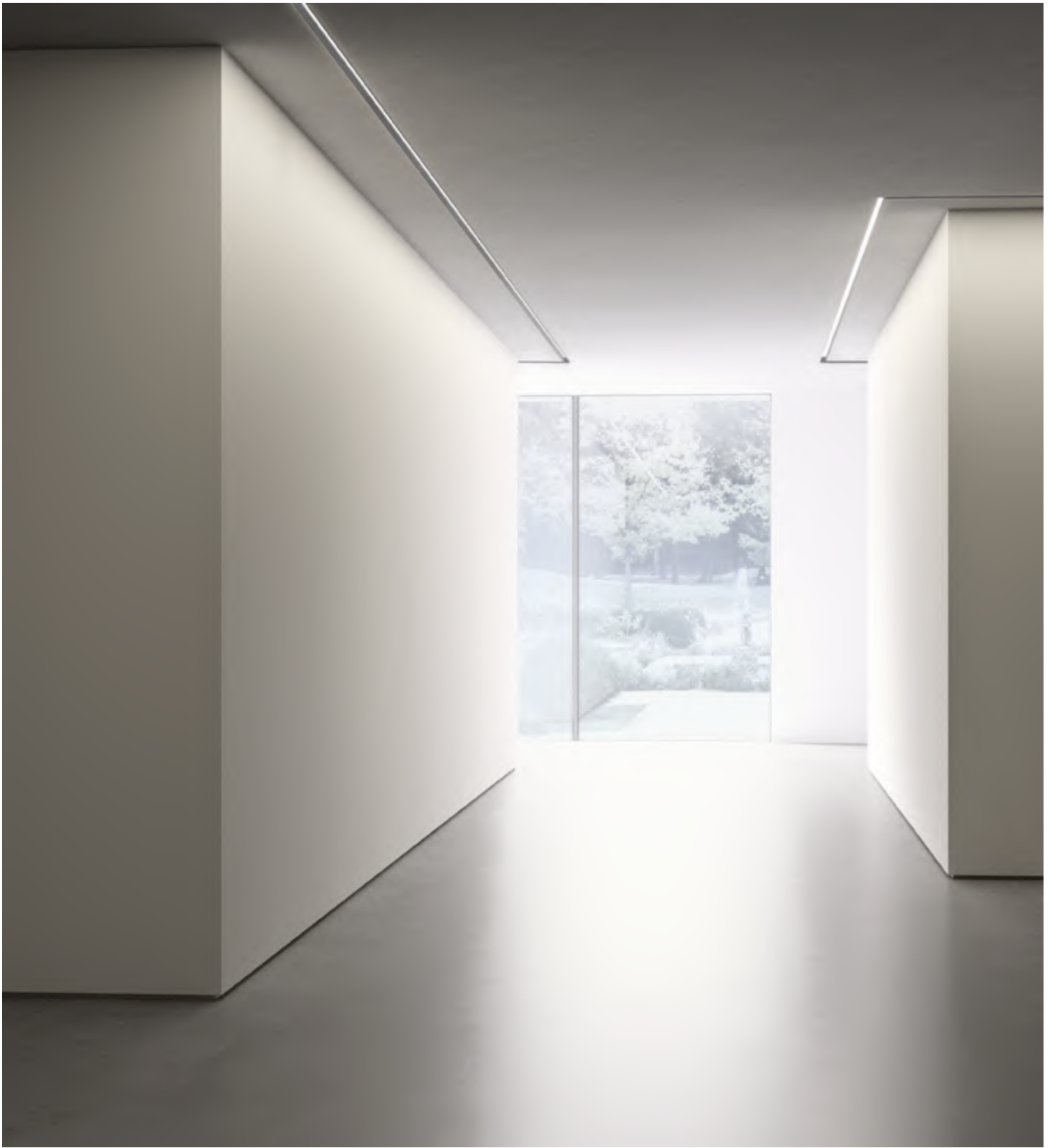

XM24701.302.0099**XM24702.302.0099**

Elemento di collegamento per due linee di profili componibili con angolo di giunzione piano di 90°, per installazione incassata a scomparsa.
Connection joint for two lines of modular profiles with level junction 90°, for total built-in installation.

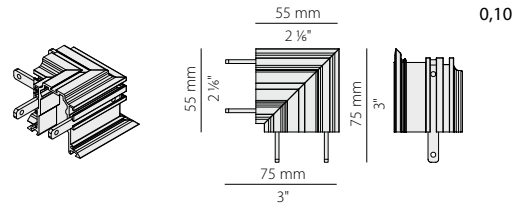
**XM24700.301.0099**

Kit di giunzione lineare.
Linear junction kit.

**XM24701.202.0099****XM24702.202.0099**

Coppia di testate di chiusura con viti.
Pair of end caps with screws.

**XM24700.201.0099**

Kit di staffe di fissaggio su cartongesso.
Drywall fixing bracket kit.

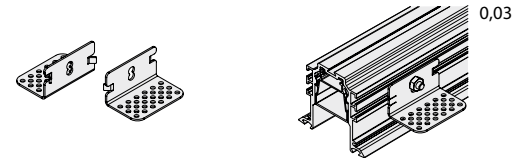
**XM2033/34/32/31-S**

Cavi di alimentazione.
Power cables.

**XM247-ALU CUT**

Taglio a richiesta di estruso di alluminio.
Extruded aluminum cut on request.

XM247-SCREEN CUT

Taglio a richiesta di schermo in policarbonato.
Polycarbonate screen cut on request.

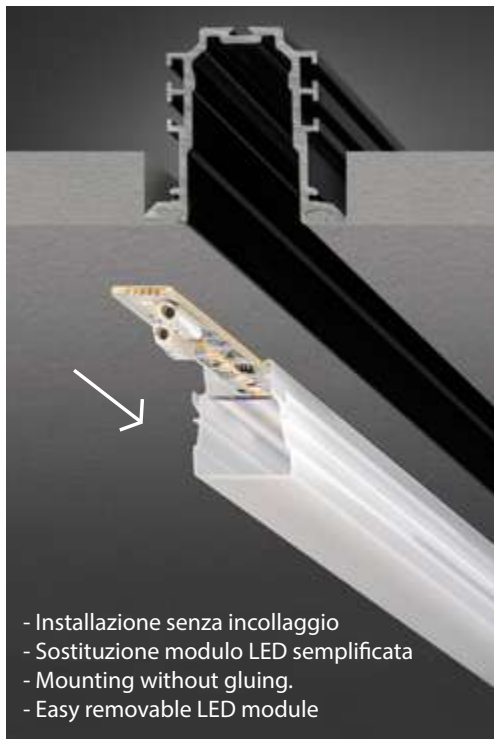

- Installazione senza incollaggio
- Sostituzione modulo LED semplificata
- Mounting without gluing.
- Easy removable LED module

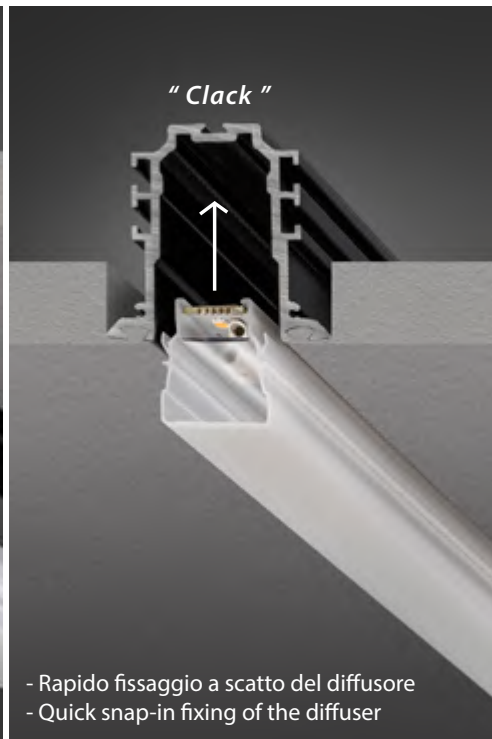

- Rapido fissaggio a scatto del diffusore
- Quick snap-in fixing of the diffuser

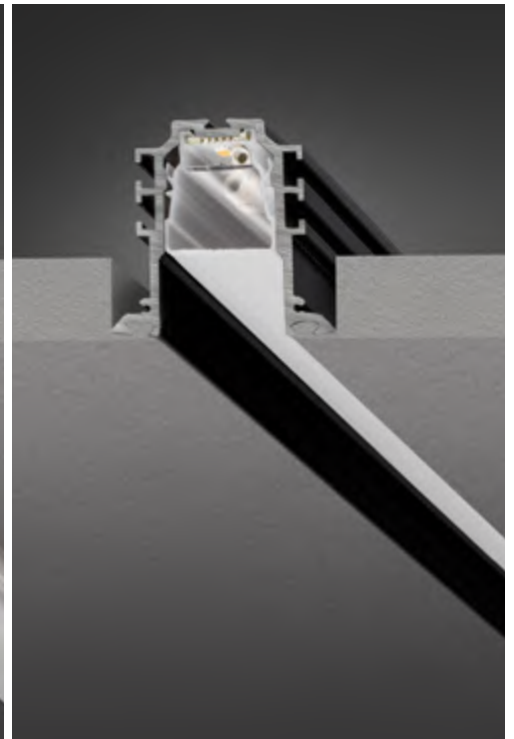



BROOKLYN ROUND XG231 - XG232



Sistema modulare in alluminio estruso sottoposto a curvatura con raggio 500mm e 1000mm disponibile in versione incasso a scomparsa, per creare anelli o composizioni miste di linee e curve su soffitto o parete. Sorgente luminosa composta da modulo LED e alimentazione remota. Finitura con vernice poliaccrilica in bianco e finitura laterale del profilo a coste. Schermo in policarbonato opale estruso e curvato. Ideale per uffici, hall, zone living, grandi spazi.

Modular system in extruded curved aluminum with 500mm and 1000mm radius available in trimless recessed version, offering the possibility to create rings or mixed compositions of lines and curves. Light source made of LED module and remote power supply unit. Polyacrylic white painted and ribbed lateral finish. Curved extruded opal polycarbonate diffuser. Ideal for offices, hall, living areas, and large areas.

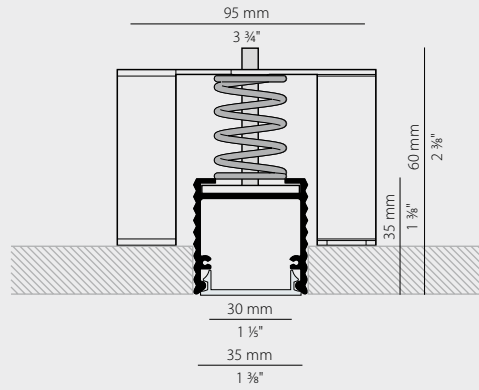

Electric options only with remote components	page 303
Dimming / Power supply	303/304
Technical information	305
Wiring diagram 1	305
Photometric data available at www.panzeri.it	

TRIMLESS PROFILE

	CODICE / CODE	DEGREES	Ø MM	Ø INCHES	H MM	H INCHES	MM	INCHES		kg
Fornito completo di schermo monouso e schermo diffusore opalino Supplied with disposable diffuser and opal diffuser	<input type="radio"/> XG23101.360.0099	360°	1000	39 3/8"	35	1 3/8"	Ø ext. 1005 / int. 926	Ø ext. 39 3/8" / int. 36 1/2"	LED IP40 IP20 850°	2,23
	<input type="radio"/> XG23101.180.0099	180°	1000	39 3/8"	35	1 3/8"	Ø ext. 1005 / int. 926	Ø ext. 39 3/8" / int. 36 1/2"		1,14
	<input type="radio"/> XG23101.090.0099	90°	1000	39 3/8"	35	1 3/8"	Ø ext. 1005 / int. 926	Ø ext. 39 3/8" / int. 36 1/2"		0,70
	<input type="radio"/> XG23201.360.0099	360°	1950	76 3/8"	35	1 3/8"	Ø ext. 1955 / int. 1876	Ø ext. 77" / int. 74"		4,83
	<input type="radio"/> XG23201.180.0099	180°	1950	76 3/8"	35	1 3/8"	Ø ext. 1955 / int. 1876	Ø ext. 77" / int. 74"		2,49
	<input type="radio"/> XG23201.090.0099	90°	1950	76 3/8"	35	1 3/8"	Ø ext. 1955 / int. 1876	Ø ext. 77" / int. 74"		1,18
	<input type="radio"/> XG23201.045.0099	45°	1950	76 3/8"	35	1 3/8"	Ø ext. 1955 / int. 1876	Ø ext. 77" / int. 74"		0,71

LED MODULE

	CODICE / CODE	DEGREES	W	LM	NR. LED	LED	V
	XM003.100.0410	45°	6,6W	855lm	48	3000K Ra>90	24V DC
	XM003.200.0410	22,5°	6,6W	855lm	48	3000K Ra>90	24V DC

CODICI COLORI DISPONIBILI / COLOUR CODES AVAILABLE

01 bianco
white

ACCESSORI / ACCESSORIES

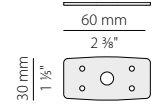
XM231/32-UGiunzione lineare.
Linear junction.

kg

€

0,01

9,50

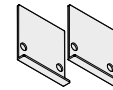
XM231/32-TRCoppia di testate di chiusura con viti per profili incassati a scomparsa.
Pair of end caps with screws for trimless recessed profiles.

0,02

10,50

XM231/32-UDGiunzione per diffusori (n. 5)
Diffuser junction (n. 5)

0,02

7,00

XM2033/34/32/31-5Cavi di alimentazione.
Power cables.

0,01

4,50

LED/DRIVER MATRIX XG231/232

CODE	LED MODULE	DRIVER	DRIVER DIM
XG23101.360.0099	8 x XM003.100.0410	1x YDV.024.060.A01	1x XM60/24 DIM
XG23101.180.0099	4 x XM003.100.0410	1x YDV.024.030.A01	1x XM35/24 DIM
XG23101.090.0099	2 x XM003.100.0410	1x YDV.024.030.A01	1x XM18/24 DIM
XG23201.360.0099	16x XM003.200.0410	1x YDV.024.120.A01	1x XM150/24 DIM
XG23201.180.0099	8 x XM003.200.0410	1x YDV.024.060.A01	1x XM60/24 DIM
XG23201.090.0099	4 x XM003.200.0410	1x YDV.024.030.A01	1x XM35/24 DIM
XG23201.045.0099	2 x XM003.200.0410	1x YDV.024.030.A01	1x XM18/24 DIM



BROOKLYN
XG2033

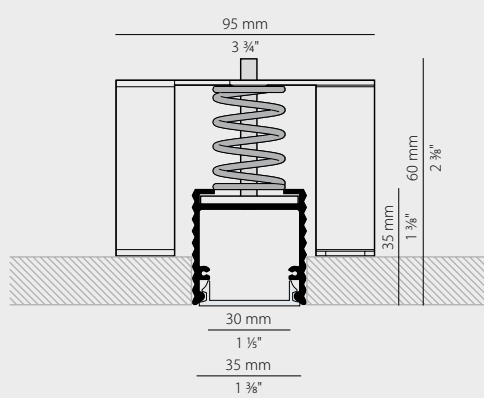

Sistema modulare LED in alluminio estruso verniciato bianco sezionabile, da incasso a scomparsa totale (trimless), per applicazioni in verticale o orizzontale per cartongesso/laterizio. Doppi schermi: il primo monouso per rasatura, stuccatura e verniciatura, il secondo definitivo opalino o microprismato. Per una corretta e facile installazione nel cartongesso sono disponibili farfalle micro regolabili opzionali, applicabili ogni 400mm ca. Moduli LED multipli da 500mm frazionabili ogni 62,5mm 3000K 8,6W 24V. Moduli LED da 125mm 3000K 2,2W 24V, completi di 2 cavetti per collegamento. Predisporre, se necessari, eventuali appendimenti.

Modular LED system in white painted extruded aluminium (trimless), dividable, and fully recessed wall for vertical or horizontal use in drywall/concrete. Two screens: the first disposable for shaving, plastering and painting, the second definitive in opaline or microprismatic finish. For a quick and easy installation in drywall, are available micro adjustable wings nut optional, applicable every 400mm approx. Multiple LED modules (500mm long) divisible every 62,5mm 3000K 8,6W 24V. Modules (125mm long) 3000K 2,2W 24V, complete with 2 connection cables. Prepare, if necessary, any hangings to support the system.

BROOKLYN TRIM
XG2034

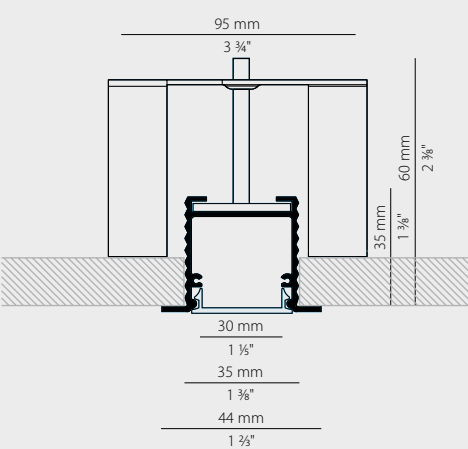

Sistema modulare LED in alluminio estruso verniciato bianco sezionabile, da incasso con bordo (trim), per applicazioni in verticale o orizzontale per cartongesso/laterizio. Per una corretta e facile installazione nel cartongesso sono disponibili farfalle opzionali, applicabili ogni 400mm ca. Moduli LED multipli da 500mm frazionabili ogni 62,5mm 3000K 8,6W 24V. Moduli LED da 125mm 3000K 2,2W 24V, completi di 2 cavetti per collegamento. Predisporre, se necessari, eventuali appendimenti.

Modular LED system in extruded aluminium painted white, for recessed installation with border (trim), for vertical or horizontal application in drywall /brick. Wings nut (an optional) are available for correct and simple installation in false ceiling applicable every 400mm approx. Multiple 500mm LED modules 8,6W 24V 3000K divisible every 62,5mm. 125mm LED modules 3000k 2,2W 24V complete with 2 connection cable. Prepare any suspensions, if necessary.

BROOKLYN OUT
XP2033

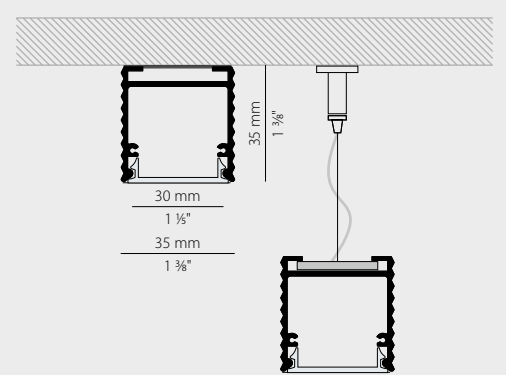
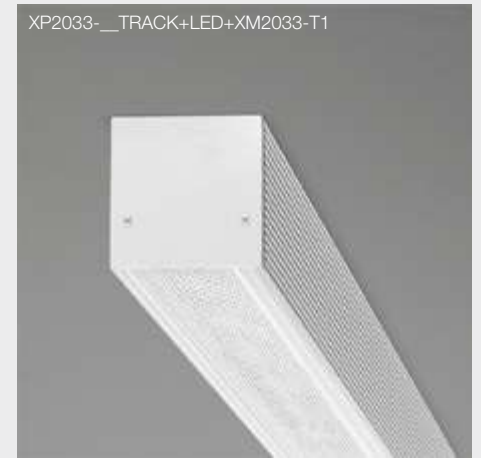

Sistema modulare LED in alluminio estruso verniciato bianco (nero a richiesta) sezionabile, da parete/plafone o a sospensione. Moduli LED multipli da 500mm frazionabili ogni 62,5mm 3000K 8,6W 24V. Moduli LED da 125mm 3000K 2,2W 24V, completi di 2 cavetti per collegamento.

Modular LED system in extruded aluminium painted white (black on request) sectionable, da parete/plafone o a sospensione. Moduli LED multipli da 500mm frazionabili ogni 62,5mm 3000K 8,6W 24V. Moduli LED da 125mm 3000K 2,2W 24V, complete with 2 connection cables.

Electric options only with remote components	page 303
Dimming / Power supply	303/304
Technical information	305
Wiring diagram 1	305
UGR <19 depending on installation conditions	
Photometric data available at www.panzeri.it	

TRIMLESS PROFILE

	CODICE / CODE	L MM	L INCHES	NR. ADVISED	MM	INCHES	kg
Fornito completo di schermo monouso e schermo diffusore opalino Supplied with disposable screen and opal diffuser	XG2033-50TRACK	510	20"	2	515 x 40	20 3/8" x 1 3/8"	0,38
	XG2033-100TRACK	1010	39 1/2"	2	1015 x 40	40" x 1 3/8"	0,83
	XG2033-200TRACK	2010	79 1/2"	3	2015 x 40	79 3/8" x 1 3/8"	1,48
	XG2033-300TRACK	3010	118 3/8"	4	3015 x 40	118 5/8" x 1 3/8"	2,21
Fornito completo di schermo monouso e schermo diffusore microprismato Supplied with disposable screen and micro-prismatic diffuser	XG2033-50TRACK PR	510	20"	2	515 x 40	20 3/8" x 1 3/8"	0,38
	XG2033-100TRACK PR	1010	39 1/2"	2	1015 x 40	40" x 1 3/8"	0,83
	XG2033-200TRACK PR	2010	79 1/2"	3	2015 x 40	79 3/8" x 1 3/8"	1,48
	XG2033-300TRACK PR	3010	118 3/8"	4	3015 x 40	118 5/8" x 1 3/8"	2,21

TRIM PROFILE

	CODICE / CODE	L MM	L INCHES	NR. ADVISED	MM	INCHES	kg
Fornito completo di schermo diffusore opalino Supplied with opal diffuser	XG2034-50TRACK	510	20"	2	515 x 40	20 3/8" x 1 3/8"	0,32
	XG2034-100TRACK	1010	39 1/2"	2	1015 x 40	40" x 1 3/8"	0,67
	XG2034-200TRACK	2010	79 1/2"	3	2015 x 40	79 3/8" x 1 3/8"	1,25
	XG2034-300TRACK	3010	118 3/8"	4	3015 x 40	118 5/8" x 1 3/8"	1,90
Fornito completo di schermo diffusore microprismato Supplied with micro-prismatic diffuser	XG2034-50TRACK PR	510	20"	2	515 x 40	20 3/8" x 1 3/8"	0,32
	XG2034-100TRACK PR	1010	39 1/2"	2	1015 x 40	40" x 1 3/8"	0,67
	XG2034-200TRACK PR	2010	79 1/2"	3	2015 x 40	79 3/8" x 1 3/8"	1,25
	XG2034-300TRACK PR	3010	118 3/8"	4	3015 x 40	118 5/8" x 1 3/8"	1,90

CEILING SUSPENSION

	CODICE / CODE	L MM	L INCHES	kg
Fornito completo di schermo diffusore opalino Supplied with opal diffuser	XP2033-50TRACK	525	20 3/8"	0,34
	XP2033-100TRACK	1025	40 3/8"	0,68
	XP2033-200TRACK	2025	79 7/8"	1,32
	XP2033-300TRACK	3025	119 1/2"	1,94
Fornito completo di schermo diffusore microprismato Supplied with micro-prismatic diffuser	XP2033-50TRACK PR	525	20 3/8"	0,34
	XP2033-100TRACK PR	1025	40 3/8"	0,68
	XP2033-200TRACK PR	2025	79 7/8"	1,32
	XP2033-300TRACK PR	3025	119 1/2"	1,94

LED MODULE

	CODICE / CODE	L MM	L INCHES	MM	INCHES	W	W/M	LM	LM/M	NR. LED	LED	V
	XM006.050.0410	500	19 3/8"	62,5	2 1/2"	8,6W	17,2W/m	1140lm	2280lm/m	64	3000K Ra>90	24V DC
	XM006.012.0410	125	5"	62,5	2 1/2"	2,15W	17,2W/m	258lm	2280lm/m	16	3000K Ra>90	24V DC
	YLR002.017.0510	5000	197"	42	1 3/8"		17,3W/m		1700lm/m	168/m	2700K Ra>90	24V DC
	YLR002.017.0410	5000	197"	42	1 3/8"		17,3W/m		1810lm/m	168/m	3000K Ra>90	24V DC
	YLR002.017.0610	5000	197"	42	1 3/8"		17,3W/m		1920lm/m	168/m	4000K Ra>90	24V DC
	YLR003.010.0510	5000	197"	42	1 3/8"		9,6W/m		882lm/m	168/m	2700K Ra>90	24V DC
	YLR003.010.0410	5000	197"	42	1 3/8"		9,6W/m		930lm/m	168/m	3000K Ra>90	24V DC
	YLR003.010.0610	5000	197"	42	1 3/8"		9,6W/m		980lm/m	168/m	4000K Ra>90	24V DC

Matrice di compatibilità LED / Profili pag. 233 / LED Profile Matrix page 233

Per composizioni miste di XG2033 e XG231/232 utilizzare solamente moduli LED XM006.050.0410 e XM006.012.0410 senza riflettore per le parti dritte.

For mix composition made of XG2033 and XG231/232 use only module LED XM006.050.0410 and XM006.012.0410 without reflector for the straight parts.

CODICI COLORI DISPONIBILI / COLOUR CODES AVAILABLE

bianco
white

DIFFUSERS

CODICE / CODE	L MM	L INCHES		kg
XM2033/34/45/46-600S	6000 x 30	236 3/8" x 1 1/8"	Schermo diffusore in policarbonato estruso con finitura opalina, di lunghezza 6000mm (236,2"). Extruded polycarbonate diffuser with opaline finish, 6000mm (236,2") long.	0,47
XM2033/34/45/46-900S	9000 x 30	354 3/8" x 1 1/8"	Schermo diffusore in policarbonato estruso con finitura opalina, di lunghezza 9000mm (354,3"). Extruded polycarbonate diffuser with opaline finish, 9000mm (354,3") long.	0,69
XM2033/34/45/46-1200S	12000 x 30	472 3/8" x 1 1/8"	Schermo diffusore in policarbonato estruso con finitura opalina, di lunghezza 12000mm (472,4"). Extruded polycarbonate diffuser with opaline finish, 12000mm (472,4") long.	0,93
XM2033/34/45/46-600S PR	6000 x 30	236 3/8" x 1 1/8"	Schermo diffusore in policarbonato estruso microprismatico, di lunghezza 6000mm (236,2"). Micro-prismatic extruded polycarbonate diffuser, 6000mm (236,2") long.	0,47
XM2033/34/45/46-900S PR	9000 x 30	354 3/8" x 1 1/8"	Schermo diffusore in policarbonato estruso microprismatico, di lunghezza 9000mm (354,3"). Micro-prismatic extruded polycarbonate diffuser, 9000mm (354,3") long.	0,69
XM2033/34/45/46-1200S PR	12000 x 30	472 3/8" x 1 1/8"	Schermo diffusore in policarbonato estruso microprismatico, di lunghezza 12000mm (472,4"). Micro-prismatic extruded polycarbonate diffuser, 12000mm (472,4") long.	0,93

ACCESSORI / ACCESSORIES
XM2033-U90

Elemento di collegamento per due linee di profili componibili con angolo di giunzione piano di 90°, per installazione a incasso a scomparsa.
Connection joint for two lines of modular profiles with level junction 90°, for total built-in installation.

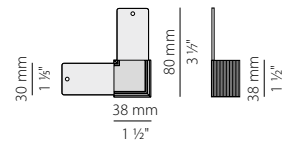
kg

0,11

XM2033-U90 XP

Elemento di collegamento per due linee di profili componibili con angolo di giunzione piano di 90°, per installazione a sospensione o a soffitto.
Connection joint for two lines of modular profiles with level junction 90°, for suspended or ceiling installation.

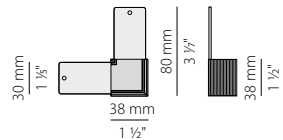

0,11

XM2034-U90

Elemento di collegamento per due linee di profili componibili con angolo di giunzione piano di 90°, per installazione a incasso.
Connection joint for two lines of modular profiles with level junction 90°, for built-in installation.

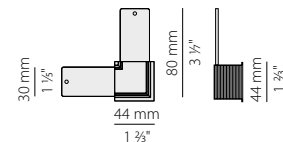

0,22

XM2033-UT

Giunzione piana per tre profili a "T", per installazione a incasso a scomparsa.
Three profiles "T" level junction, for total built-in installation.

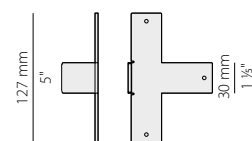
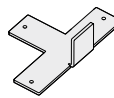

0,17

XM2033-X

Giunzione piana per quattro profili a "X", per installazione a incasso a scomparsa.
Four profiles "X" level junction, for total built-in installation.

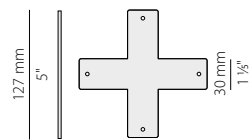
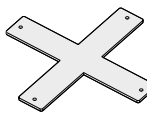

0,16

XM2033/34-ANG

Giunzione perpendicolare per due profili con taglio a 45°.
Two profiles perpendicular junction with 45° cut.

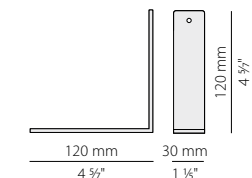

0,15

XM2033-U45

Giunzione piana per due profili con taglio a 45°, per installazione a incasso a scomparsa.
Two profiles level junction with 45° cut, for total built-in installation.

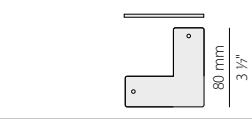

0,01





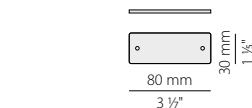





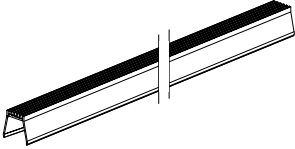

XM2033/34-U

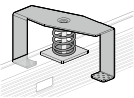
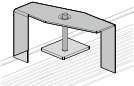
Giunzione lineare.
Linear junction.

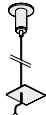

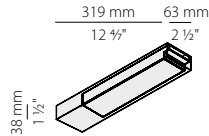
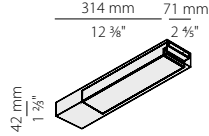
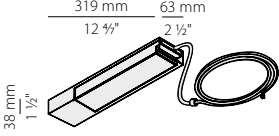
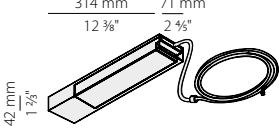
0,06



		kg
XM2033/34-WHI Riflettore bianco di lunghezza 1000mm (39,4") sezionabile. White reflector with 1000mm (39,4") length to be cut.		0,23
XM2033-T Coppia di testate di chiusura con viti per profili incassati a scomparsa. Pair of end caps with screws for trimless recessed profiles.		0,02
XM2033-T1 Coppia di testate di chiusura con viti per profili installati a sospensione o a soffitto. Pair of end caps with screws for suspended or ceiling mounted profiles.		0,02
XM2034-T Coppia di testate di chiusura con viti per profili incassati. Pair of end caps with screws for recessed profiles.		0,17
XM2033-F Farfalla di fissaggio su cartongesso per profili incassati a scomparsa. Drywall fixing bracket for trimless recessed profiles.		0,07
XM2034-F Farfalla di fissaggio su cartongesso per profili incassati. Drywall fixing bracket for recessed profiles.		0,17
XM2033/34-L Coppia di piastrine di fissaggio per incasso in muratura. Pair of fixing plates for recessed installation in brick wall or concrete.		0,04
XM-KIT-S Kit di sospensione singolo. Single suspension kit.		0,05
XM2033/34/38/39P Piastrina per appendimento. Plate for hanging.		0,01
XM2033-T120W Kit di alimentazione con rosone bianco e alimentatore 120W. Power supply kit with white canopy and 120W driver.		1,22
XM2033-T150W DIM Kit di alimentazione con rosone bianco e alimentatore 150W dimmerabile DALI/ Push DIM. Power supply kit with white canopy and 150W DALI/Push DIM dimmable driver.		1,61
XM2033-ST120W Kit di alimentazione con rosone bianco, alimentatore 120W, cavo di alimentazione di lunghezza 2,2m (86,6"). Power supply kit with white canopy, 120W driver, power cable with length 2,2m (86,6").		1,39
XM2033-ST150W DIM Kit di alimentazione con rosone bianco, alimentatore 150W dimmerabile DALI/ Push DIM, cavo di alimentazione di lunghezza 2,2m (86,6"). Power supply kit with white canopy, 150W DALI/Push DIM dimmable driver, power cable with length 2,2m (86,6").		1,72
XM2033/34/32/31-S Cavi di alimentazione. Power cables.		0,01
XM2033-A Coppia di copriluce adesivi per giunzioni. Pair of adhesive light covers for junctions.		
XM231/32-P Distanziale per installazione a soffitto/parete. Spacer for ceiling/wall installation.		0,08

XM2033-ALU CUT

Taglio a richiesta di estruso di alluminio.
Extruded aluminum cut on request.

XM2033-SCREEN CUT

Taglio a richiesta di schermo in policarbonato.
Polycarbonate screen cut on request.

**BROOKLYN SPOT XG203**

Enzo Panzeri 2015

Registered Design

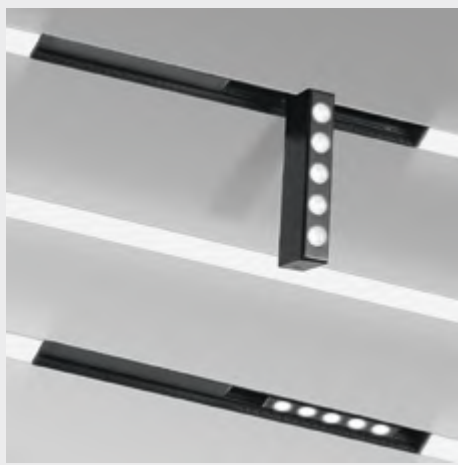

Photometric data available at www.panzeri.it

Spot nero o bianco orientabile per profilo Brooklyn completo di driver, predisposto con cablaggio passante 24V per alimentare il resto del sistema Brooklyn. Da non usarsi in partenza o alla fine. Disponibile anche la versione singola a plafone bianca o nera.

Adjustable black or white spot for Brooklyn profile driver included, spot supplied with 24V through wiring to power the entire Brooklyn system. Never to be used at the beginning or at the end. Single ceiling version also available.

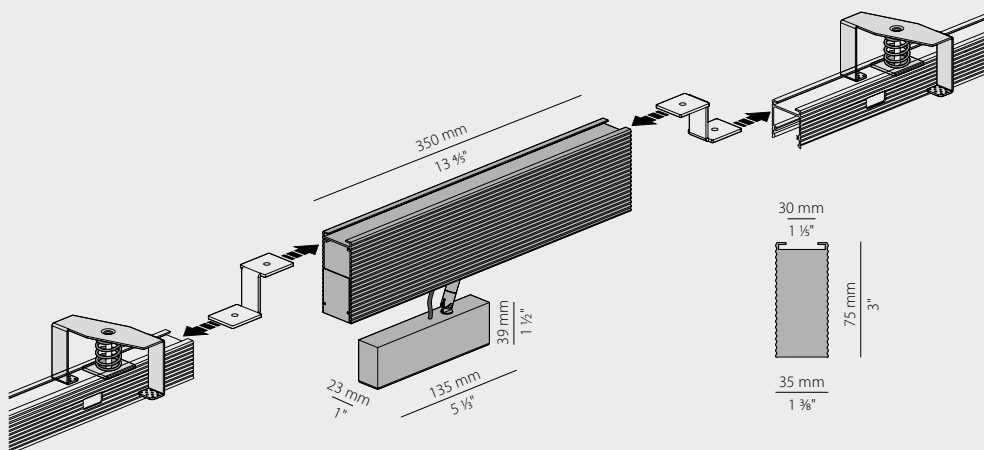

DISPONIBILE ANCHE VERSIONE A PLAFONE P203...035.2601 VEDI PAG. 36
AVAILABLE IN CEILING VERSION TOO P203...035.2601 SEE PAGE 36

TRIMLESS PROFILE

CODICE / CODE	L MM	L INCHES	Profile		W	LM	LED	V	EL	kg
			MM	INCHES						
XG20301.035.2601	350	13 7/8"	355 x 40	14" x 1 3/8"	10W	698lm	3000K Ra>90 41°	220-240V AC	ON-OFF	1,18
XG20302.035.2601	350	13 7/8"	355 x 40	14" x 1 3/8"	10W	698lm	3000K Ra>90 41°	220-240V AC	ON-OFF	1,18

CODICI COLORI DISPONIBILI / COLOUR CODES AVAILABLE

01 bianco
white

02 nero
black

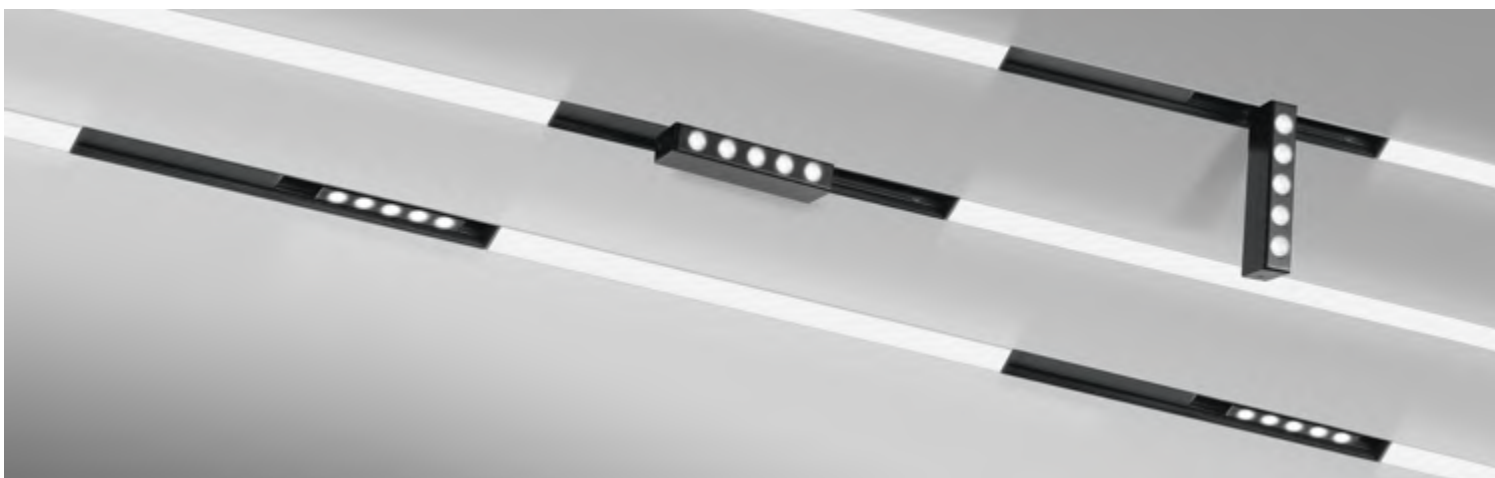



CORNER XG2045



Sistema modulare a soffitto o parete caratterizzato dal posizionamento arretrato della sorgente. L'installazione prevede l'ancoraggio alle superfici perimetrali e l'inserimento finale del pannello in cartongesso a filo con l'estruso, per un effetto di luce a scomparsa.

Modular LED system in extruded aluminum white painted, for wall or ceiling perimeter installation, characterized by the back positioning of the light source. The installation foresees the fixation of profiles to side surfaces and the final placing of plasterboard panel flush with the extruded body, to have a total recessed light effect.

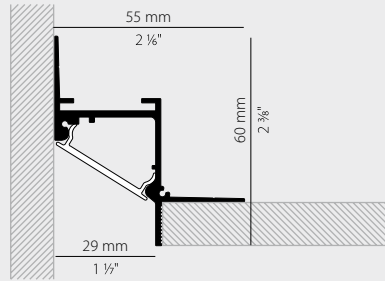

Electric options only with remote components	page 303
Dimming / Power supply	303/304
Technical information	305
Wiring diagram 1-2	305
UGR <19 depending on installation conditions	
Photometric data available at www.panzeri.it	

TRIMLESS PROFILE

LED IP40 IP20

	CODICE / CODE	L MM	L INCHES	kg
Fornito completo di schermo diffusore	XG2045-50TRACK	510	20"	0,45
Supplied with diffuser	XG2045-100TRACK	1010	39 4/8"	0,78
	XG2045-200TRACK	2010	79 1/8"	1,45
	XG2045-300TRACK	3010	118 3/8"	2,05

LED MODULE



	CODICE / CODE	L MM	L INCHES	MM	INCHES	W	W/M	LM	LM/M	NR. LED	LED	V
	XM006.050.0410	500	19 3/8"	62,5	2 1/2"	8,6W	17,2W/m	1140lm	2280lm/m	64	3000K Ra>90	24V DC
	XM006.012.0410	125	5"	62,5	2 1/2"	2,15W	17,2W/m	258lm	2280lm/m	16	3000K Ra>90	24V DC
	YLR001.022.0110	5000	197"	50	2"		21,6W/m		3020lm/m	160/m	3000K Ra>80	24V DC
	YLR002.017.0510	5000	197"	42	1 3/8"		17,3W/m		1700lm/m	168/m	2700K Ra>90	24V DC
	YLR002.017.0410	5000	197"	42	1 3/8"		17,3W/m		1810lm/m	168/m	3000K Ra>90	24V DC
	YLR002.017.0610	5000	197"	42	1 3/8"		17,3W/m		1920lm/m	168/m	4000K Ra>90	24V DC
	YLR003.010.0510	5000	197"	42	1 3/8"		9,6W/m		882lm/m	168/m	2700K Ra>90	24V DC
	YLR003.010.0410	5000	197"	42	1 3/8"		9,6W/m		930lm/m	168/m	3000K Ra>90	24V DC
	YLR003.010.0610	5000	197"	42	1 3/8"		9,6W/m		980lm/m	168/m	4000K Ra>90	24V DC

Matrice di compatibilità LED / Profili pag. 233 / LED Profile Matrix page 233

DIFFUSERS

	CODICE / CODE	L MM	L INCHES	kg
	XM2033/34/45/46-600S	6000 x 30	236 3/8" x 1 1/8"	0,47
	XM2033/34/45/46-900S	9000 x 30	354 3/8" x 1 1/8"	0,69
	XM2033/34/45/46-1200S	12000 x 30	472 1/8" x 1 1/8"	0,93

Schermo diffusore in policarbonato estruso con finitura opalina, di lunghezza 6000mm (236,2").
Extruded polycarbonate diffuser with opaline finish, 6000mm (236,2") long.

Schermo diffusore in policarbonato estruso con finitura opalina, di lunghezza 9000mm (354,3").
Extruded polycarbonate diffuser with opaline finish, 9000mm (354,3") long.

Schermo diffusore in policarbonato estruso con finitura opalina, di lunghezza 12000mm (472,4").
Extruded polycarbonate diffuser with opaline finish, 12000mm (472,4") long.

CODICI COLORI DISPONIBILI / COLOUR CODES AVAILABLE

01 bianco
white

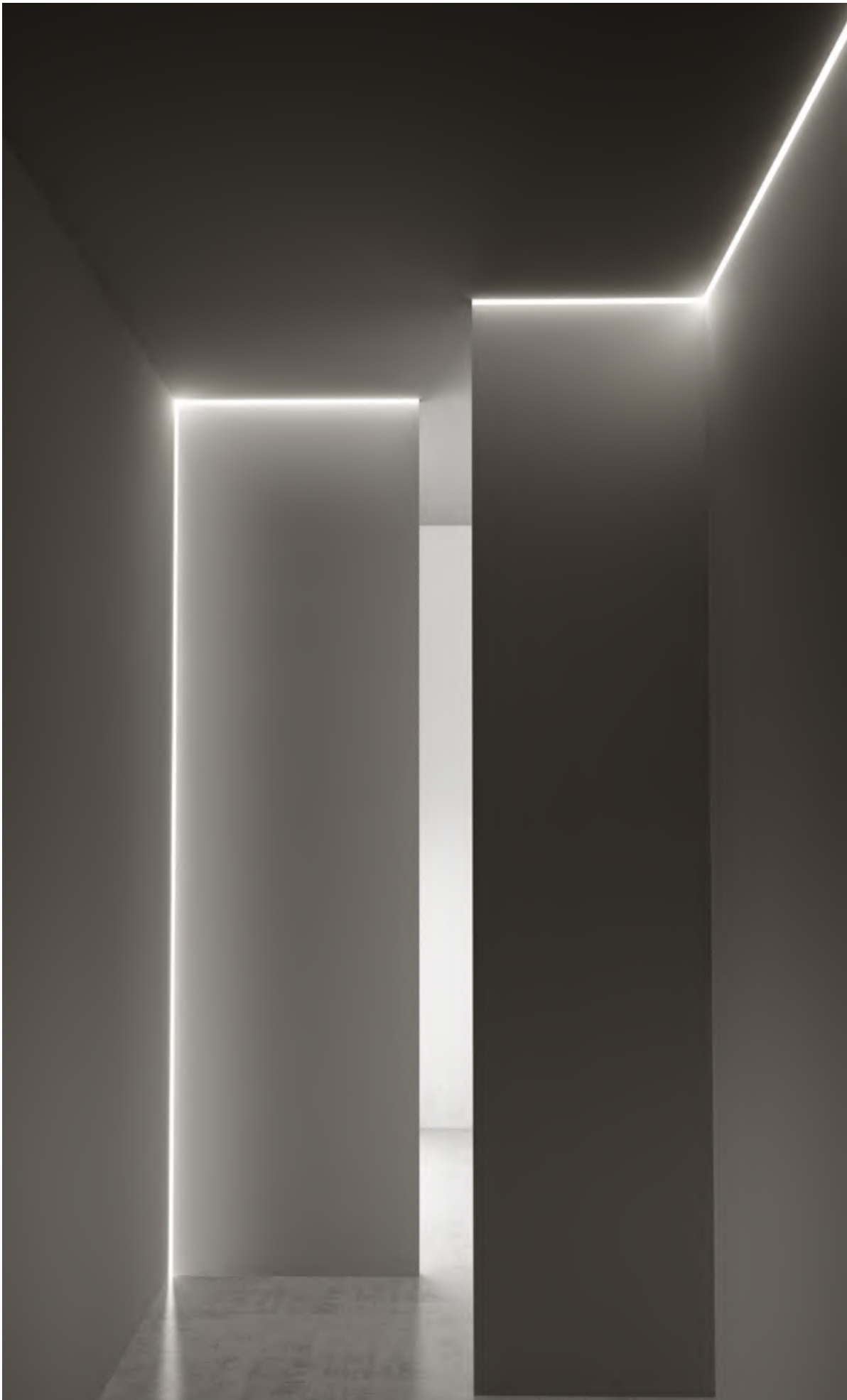

XM2045-U90 1

Elemento di collegamento per due linee di profili componibili con angolo di giunzione piano interno di 90°, per installazione perimetrale.
Connection joint for two lines of modular profiles with internal level junction 90°, for perimetral installation.

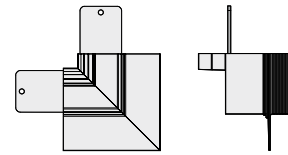
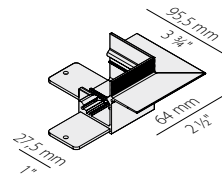

0,09

XM2045-U90 2

Elemento di collegamento per due linee di profili componibili con angolo di giunzione piano esterno di 90°, per installazione perimetrale.
Connection joint for two lines of modular profiles with external level junction 90°, for perimetral installation.

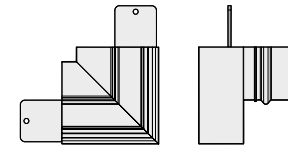
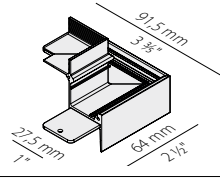

0,13

XM2045-ANG 3

Elemento di collegamento per due linee di profili componibili con angolo di giunzione perpendicolare interno di 90°, per installazione perimetrale.
Connection joint for two lines of modular profiles with internal perpendicular junction 90°, for perimetral installation.

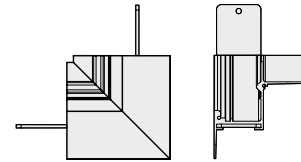
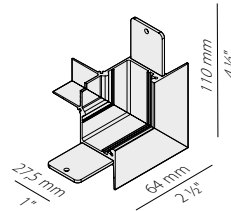

0,11

XM2045-ANG 4

Elemento di collegamento per due linee di profili componibili con angolo di giunzione perpendicolare esterno di 90°, per installazione perimetrale.
Connection joint for two lines of modular profiles with external perpendicular junction 90°, for perimetral installation.

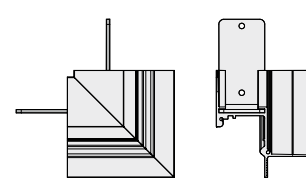
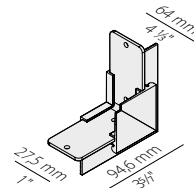

0,09

XM2045-U

Giunzione lineare.
Linear junction.

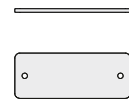
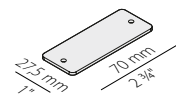

0,03

XM2045-T

Coppia di testate di chiusura con viti.
Pair of end caps with screws.



0,01

XM2045-CUT

Taglio lineare per moduli dritti.
Linear cut for straight modules.

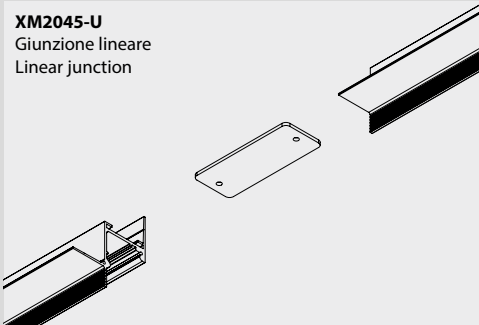
XM2045-U
Giunzione lineare
Linear junction**XM2045-U90 1**

Angolo 1 piano 90° parete-parete / soffitto-soffitto misure esterne 64x64mm
Angle 1 horizontal 90° wall-wall / ceiling-ceiling, external measurements 64x64mm

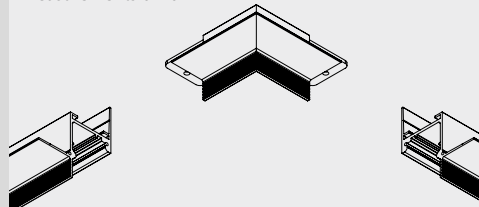
**XM2045-U90 2**

Angolo 2 piano 90° parete-parete / soffitto-soffitto misure esterne 64x64mm
Angle 2 horizontal 90° wall-wall / ceiling-ceiling, external measurements 64x64mm

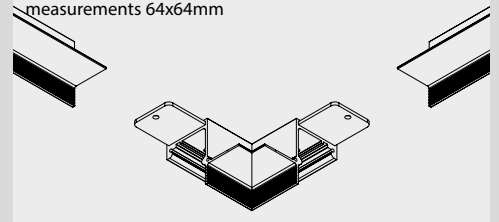
**XM2045-ANG 3**

Angolo 3 verticale 90° parete-soffitto/parete-parete misure esterne 64x64mm
Angle 3 vertical 90° wall-ceiling / wall-wall, external measurements 64x64mm

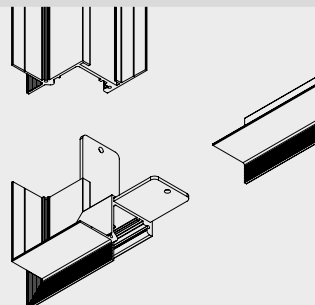
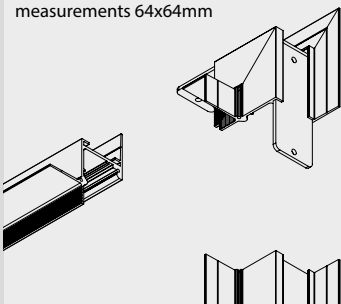
**XM2045-ANG 4**

Angolo 4 orizzontale 90° parete-parete misure esterne 64x64mm
Angle 4 horizontal 90° wall-wall, external measurements 64x64mm



GIANO XP246

XP246__+LED+FEEDING KIT +XM246-__T



Sistema modulare in alluminio estruso disponibile in versione sospensione o parete. Sorgente luminosa composta da modulo LED a luce diretta e indiretta e driver ON-OFF con accensione separata o DALI/Push DIM da integrare all'interno del profilo. Finitura con vernice poliaccrilica in bianco o nero e finitura frontale del profilo liscia. Schermo in policarbonato estruso opale o microprismatico. Ideale per uffici, corridoi, scale.

Modular extruded aluminum wall and suspension system. Light source made of LED module with direct and indirect light and separate switching ON-OFF or DALI/Push DIM drivers to be integrated into the profile. Finish in polyacrylic paint in white or black and smooth front finish of the profile. Diffuser in opal or micro prismatic polycarbonate. Ideal for offices, corridors, stairways.

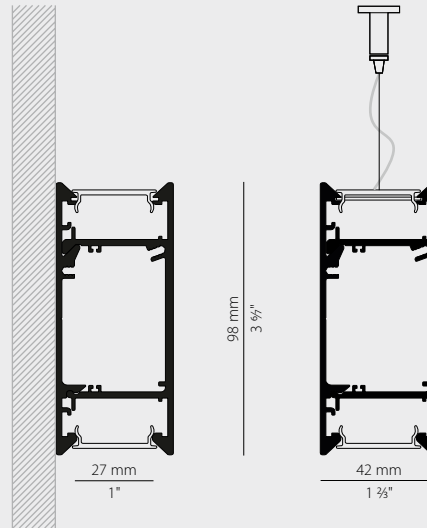

Electric options	page 300
Technical information	305
Wiring diagram 1	305
UGR <19 depending on installation conditions	
Photometric data available at www.panzeri.it	

WALL SUSPENSION

IP40 850°

	CODICE / CODE	L MM	L INCHES	kg
Fornito completo di n.2 schermi diffusori opalini	XP24646.050.0099	515	20 3/8"	1,19
Supplied with n.2 opal diffuser	XP24648.050.0099	515	20 3/8"	1,19
	XP24646.100.0099	1015	40"	2,38
	XP24648.100.0099	1015	40"	2,38
	XP24646.200.0099	2015	79 3/8"	4,76
	XP24648.200.0099	2015	79 3/8"	4,76
	XP24646.300.0099	3015	118 3/8"	7,14
	XP24648.300.0099	3015	118 3/8"	7,14

LED MODULE



	CODICE / CODE	L MM	L INCHES	MM	INCHES	W	W/M	LM	LM/M	NR. LED	LED	V
	XM006.050.0410	500	19 3/8"	62,5	2 1/2"	8,6W	17,2W/m	1140lm	2280lm/m	64	3000K Ra>90	24V DC
	XM006.012.0410	125	5"	62,5	2 1/2"	2,15W	17,2W/m	258lm	2280lm/m	16	3000K Ra>90	24V DC
	YLR002.017.0510	5000	197"	42	1 3/8"		17,3W/m		1700lm/m	168/m	2700K Ra>90	24V DC
	YLR002.017.0410	5000	197"	42	1 3/8"		17,3W/m		1810lm/m	168/m	3000K Ra>90	24V DC
	YLR002.017.0610	5000	197"	42	1 3/8"		17,3W/m		1920lm/m	168/m	4000K Ra>90	24V DC
	YLR003.010.0510	5000	197"	42	1 3/8"		9,6W/m		882lm/m	168/m	2700K Ra>90	24V DC
	YLR003.010.0410	5000	197"	42	1 3/8"		9,6W/m		930lm/m	168/m	3000K Ra>90	24V DC
	YLR003.010.0610	5000	197"	42	1 3/8"		9,6W/m		980lm/m	168/m	4000K Ra>90	24V DC

Matrice di compatibilità LED / Profili pag. 233 / LED Profile Matrix page 233

CODICI COLORI DISPONIBILI / COLOUR CODES AVAILABLE

46 bianco/schermo opalino white/opal screen	48 nero/schermo opalino black/opal screen	01 bianco white	02 nero black
---	---	---------------------------	-------------------------





DIFFUSERS

CODICE / CODE	L MM	L INCHES		kg
XM2033/34/45/46-600S	6000 x 30	236 3/8" x 1 1/8"	Schermo diffusore in policarbonato estruso con finitura opalina, di lunghezza 6000mm (236,2"). Extruded polycarbonate diffuser with opaline finish, 6000mm (236,2") long.	0,47
XM2033/34/45/46-900S	9000 x 30	354 3/8" x 1 1/8"	Schermo diffusore in policarbonato estruso con finitura opalina, di lunghezza 9000mm (354,3"). Extruded polycarbonate diffuser with opaline finish, 9000mm (354,3") long.	0,69
XM2033/34/45/46-1200S	12000 x 30	472 3/8" x 1 1/8"	Schermo diffusore in policarbonato estruso con finitura opalina, di lunghezza 12000mm (472,4"). Extruded polycarbonate diffuser with opaline finish, 12000mm (472,4") long.	0,93
XM2033/34/45/46-600S PR	6000 x 30	236 3/8" x 1 1/8"	Schermo diffusore in policarbonato estruso microprismatico, di lunghezza 6000mm (236,2"). Micro-prismatic extruded polycarbonate diffuser, 6000mm (236,2") long.	0,47
XM2033/34/45/46-900S PR	9000 x 30	354 3/8" x 1 1/8"	Schermo diffusore in policarbonato estruso microprismatico, di lunghezza 9000mm (354,3"). Micro-prismatic extruded polycarbonate diffuser, 9000mm (354,3") long.	0,69
XM2033/34/45/46-1200S PR	12000 x 30	472 3/8" x 1 1/8"	Schermo diffusore in policarbonato estruso microprismatico, di lunghezza 12000mm (472,4"). Micro-prismatic extruded polycarbonate diffuser, 12000mm (472,4") long.	0,93

ACCESSORI / ACCESSORIES

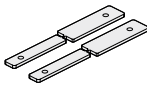
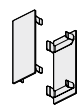
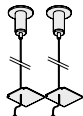
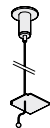
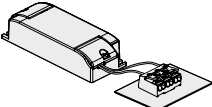
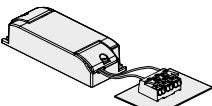
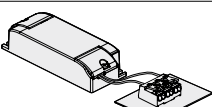
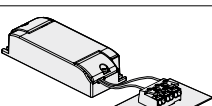
		kg
XM246-U Kit di giunzione lineare. Linear junction kit.		0,04
XM246-01T XM246-02T Coppia di testate di chiusura. Pair of end caps.		0,03
XM246-01-KIT-S XM246-02-KIT-S Coppia di kit di sospensione. Pair of suspension kits.		0,12
XM246-01-KIT-S1 XM246-02-KIT-S1 Kit di sospensione singolo per giunzioni. Single suspension kit for junctions.		0,06
XM30/24I Alimentatore LED, 30W 24V DC. LED driver, 30W 24V DC.		0,04
XM60/24I Alimentatore LED, 60W 24V DC. LED driver, 60W 24V DC.		0,30
XM120/24I Alimentatore LED, 120W 24V DC. LED driver, 120W 24V DC.		0,28
XM180/24I Alimentatore LED, 180W 24V DC. LED driver, 180W 24V DC.		0,51

ACCESSORI / ACCESSORIES

kg

XM35/24I DIM

Alimentatore LED, 35W 24V DC, dimmerabile DALI/Push DIM.
LED driver, 35W 24V DC, DALI/Push DIM dimmable.

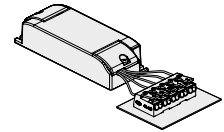

0,15

XM60/24I DIM

Alimentatore LED, 60W 24V DC, dimmerabile DALI/Push DIM.
LED driver, 60W 24V DC, DALI/Push DIM dimmable.

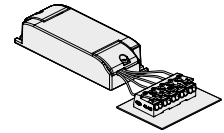

0,18

XM100/24I DIM

Alimentatore LED, 100W 24V DC, dimmerabile DALI/Push DIM.
LED driver, 100W 24V DC, DALI/Push DIM dimmable.

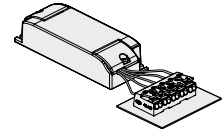

0,27

XM150/24I DIM

Alimentatore LED, 150W 24V DC, dimmerabile DALI/Push DIM.
LED driver, 150W 24V DC, DALI/Push DIM dimmable.

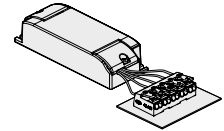

0,29

XM2038/46-3

Kit di alimentazione con rosone bianco, cavo di alimentazione a 3 poli di lunghezza 2,2m (86,6").
Power supply kit with white canopy, 3 pole power cable with length 2,2m (86,6").

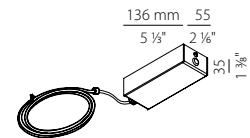

0,45

XM2038/46-5

Kit di alimentazione con rosone bianco, cavo di alimentazione a 5 poli di lunghezza 2,2m (86,6").
Power supply kit with white canopy, 5 pole power cable with length 2,2m (86,6").

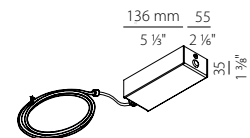

0,56

XM246-ALU CUT

Taglio a richiesta di estruso di alluminio.
Extruded aluminum cut on request.

XM246-SCREEN CUT

Taglio a richiesta di schermo in policarbonato.
Polycarbonate screen cut on request.

DRIVER MATRIX XP246

CODE	KIT ALIMENTAZIONE INTERNA POWER SUPPLY KIT	KIT ALIMENTAZIONE DALI / PUSH DIM INTERNA DALI / PUSH DIM POWER SUPPLY KIT
XP246__050.0099	1x XM30/24I	1x XM35/24I DIM
XP246__100.0099	1x XM60/24I	1x XM60/24I DIM
XP246__200.0099	1x XM120/24I	1x XM100/24I DIM
XP246__300.0099	1x XM120/24I	1x XM150/24I DIM



HARLEM XG251

Enzo Panzeri 2022

Patent pending

XG251_+_LED+YTC25101.K02



Sistema modulare di profili in alluminio estruso verniciato bianco, studiati per l'incasso in pannelli di cartongesso con effetto di scomparsa totale. La forma è pensata per non interferire con i telai di sostegno dei pannelli, garantendo la possibilità di posa in fila continua in qualunque punto della struttura. Le superfici forate su cui applicare il materiale per la rasatura assicurano una tenuta del gesso nel tempo; il risultato ottimale delle operazioni di rasatura, stuccatura e verniciatura è agevolato anche dalla presenza dello schermo monouso fornito di serie. Ogni modulo è completo di diffusore in policarbonato opalino.

Modular system of profiles in extruded aluminum in white finish, conceived for total recessed installation in drywall. The design allow not to interfere with the support frames of drywall panels, and grant free installation wherever required. The perforated surface of the profile enhances a durable application of plaster over time; moreover the disposable screen for installation ensures an optimal result in plastering and finishing the wall or ceiling. Supplied with additional opal polycarbonate diffuser.

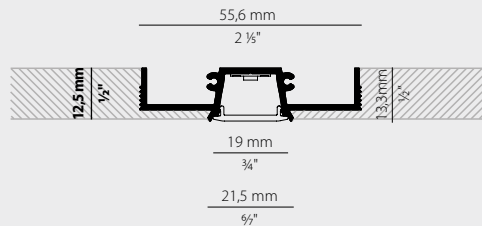

Electric options	page 300
Technical information	305
Wiring diagram 1	305
UGR <19 depending on installation conditions	
Photometric data available at www.panzeri.it	

TRIMLESS PROFILE

	CODICE / CODE	L MM	L INCHES	IP40 IP20		kg
				MM	INCHES	
Fornito completo di schermo monouso e schermo diffusore opalino	XG25101.100.0099	1010	39 1/8"	1015 x 55	40" x 2 1/8"	
Supplied with disposable screen and opal diffuser	XG25101.200.0099	2010	79 1/8"	2015 x 55	79 3/8" x 2 1/8"	
	XG25101.300.0099	3010	118 3/8"	3015 x 55	118 3/8" x 2 1/8"	

LED MODULE

	CODICE / CODE	L MM	L INCHES	✂ ✂		W/M	LM/M	NR. LED	LED	V
				MM	INCHES					
	YLR002.017.0510	5000	197"	42	1 3/8"	17,3W/m	1700lm/m	168/m	2700K Ra>90	24V DC
	YLR002.017.0410	5000	197"	42	1 3/8"	17,3W/m	1810lm/m	168/m	3000K Ra>90	24V DC
	YLR002.017.0610	5000	197"	42	1 3/8"	17,3W/m	1920lm/m	168/m	4000K Ra>90	24V DC
	YLR003.010.0510	5000	197"	42	1 3/8"	9,6W/m	882lm/m	168/m	2700K Ra>90	24V DC
	YLR003.010.0410	5000	197"	42	1 3/8"	9,6W/m	930lm/m	168/m	3000K Ra>90	24V DC
	YLR003.010.0610	5000	197"	42	1 3/8"	9,6W/m	980lm/m	168/m	4000K Ra>90	24V DC

Matrice di compatibilità LED / Profili pag. 233 / LED Profile Matrix page 233

CODICI COLORI DISPONIBILI / COLOUR CODES AVAILABLE

01 bianco
white

ACCESSORI / ACCESSORIES

YTC25101.K02

Coppia di testate di chiusura con viti.
Pair of end caps with screws.

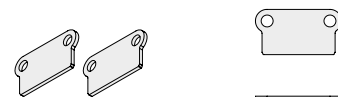

XM27000.301.0099

Kit di giunzione lineare.
Linear junction kit.

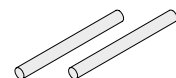



KIPS ROUND XG271-XG272-XG273

XG271/272/273_+LED+XM27001.202.0099

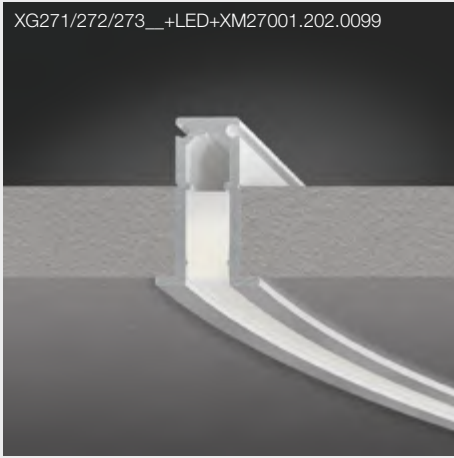

Profilo in alluminio estruso ad incasso di piccole dimensioni, strip LED con guaina in silicone bianco opale da acquistare separatamente. Studiato per consentire l'installazione su pannelli in cartongesso a soffitto o parete. Disponibili moduli lineari e curvi, con molteplici possibilità di combinazione.

Small extruded aluminum profile recessed, with LED strip with opal white silicone sheath to order separately. Designed to allow installation on ceiling or wall plasterboard panels. Linear and curved modules are available with multiple combination possibilities.

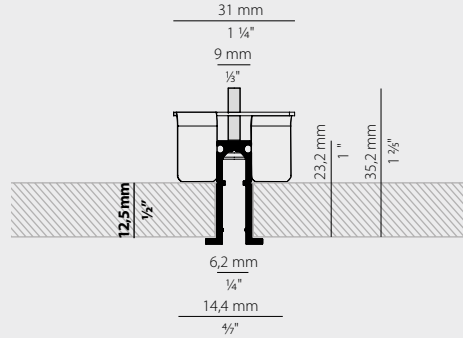

Electric options only with remote components	page 303
Dimming / Power supply	303/304
Technical information	305
Wiring diagram 2	305
Photometric data available at www.panzeri.it	

TRIM PROFILE

CODICE / CODE	DEGREES	Ø MM	Ø INCHES	H MM	H INCHES	NR. ADVISED	IP40 IP20 850°		kg
							MM	INCHES	
<input type="radio"/> XG27101.100.0099	45°	1033	40 5/8"	23,2	1"	2	Ø ext. 1029 / int. 1008	Ø ext. 40 1/2" / int. 39 3/8"	0,09
<input type="radio"/> XG27201.100.0099	90°	1033	40 5/8"	23,2	1"	2	Ø ext. 1029 / int. 1008	Ø ext. 40 1/2" / int. 39 3/8"	0,18
<input type="radio"/> XG27301.100.0099	180°	1033	40 5/8"	23,2	1"	3	Ø ext. 1029 / int. 1008	Ø ext. 40 1/2" / int. 39 3/8"	0,36

LED MODULE

CODICE / CODE	L MM	L INCHES	✂		W	LM	LM/M	LED	V
			MM	INCHES					
 YLR101.011.0110	1000	39 3/8"	50	2"	10,6W	401lm	401lm/m	3000K Ra>80	24V DC
YLR102.011.0110	5000	197"	50	2"	10,6W/m	2005lm	401lm/m	3000K Ra>80	24V DC

Matrice di compatibilità LED / Profili pag. 233 / LED Profile Matrix page 233

CODICI COLORI DISPONIBILI / COLOUR CODES AVAILABLE

01 bianco
white

Esempio di composizione / Example of configuration:

- N.3 Kips Round XG27201.100.0099
- N.4 Kips XG27001.050.0099
- N.14 wing nut XM2701.201.0099
- N.6 kit linear junction XM27000.301.0099
- N.1 kit faston XM27000.401.0099
- N.2 strip LED YLR102.011.0110
- N.1 driver YDV.024.120.A01





KIPS XG270

XG270_+LED+XM27001.202.0099



Profilo in alluminio estruso ad incasso di piccole dimensioni, strip LED con guaina in silicone bianco opale da acquistare separatamente. Studiato per consentire l'installazione su pannelli in cartongesso a soffitto o parete. Disponibili moduli lineari e curvi, con molteplici possibilità di combinazione.

Small extruded aluminum profile recessed, with LED strip with opal white silicone sheath to order separately. Designed to allow installation on ceiling or wall plasterboard panels. Linear and curved modules are available with multiple combination possibilities.

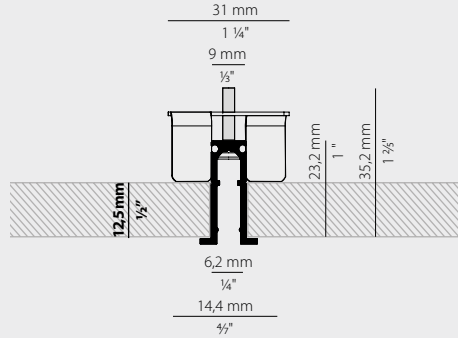

Electric options only with remote components	page 303
Dimming / Power supply	303/304
Technical information	305
Wiring diagram 2	305
Photometric data available at www.panzeri.it	

TRIM PROFILE

CODICE / CODE	L MM	L INCHES	NR. ADVISED	MM	INCHES	kg
XG27001.050.0099	500	19 3/8"	2	505 x 11	19 8/8" x 3/8"	0,11
XG27001.100.0099	1000	39 3/8"	2	1005 x 11	39 3/8" x 3/8"	0,23
XG27001.200.0099	2000	78 4/8"	3	2005 x 11	79" x 3/8"	0,45
XG27001.300.0099	3000	118 1/8"	4	3005 x 11	118 2/8" x 3/8"	0,68

LED MODULE

CODICE / CODE	L MM	L INCHES	MM	INCHES	W	LM	LM/M	LED	V
YLR101.011.0110	1000	39 3/8"	50	2"	10,6W	401lm	401lm/m	3000K Ra>80	24V DC
YLR102.011.0110	5000	197"	50	2"	10,6W/m	2005lm	401lm/m	3000K Ra>80	24V DC

Matrice di compatibilità LED / Profili pag. 233 / LED Profile Matrix page 233

CODICI COLORI DISPONIBILI / COLOUR CODES AVAILABLE

01 bianco
white

ACCESSORI / ACCESSORIES

XM27000.201.0099

Farfalla di fissaggio su cartongesso.
Drywall fixing bracket.

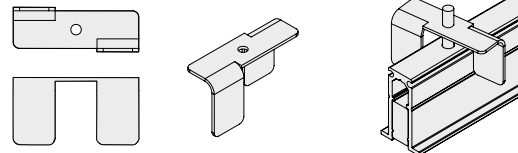

XM27001.202.0099

Coppia di testate di chiusura con viti.
Pair of end caps with screws.

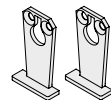

XM27000.301.0099

Kit di giunzione lineare.
Linear junction kit.

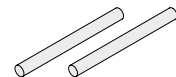

XM27000.401.0099

Kit di faston per il collegamento elettrico (10 pezzi).
Faston kit for electrical connection (10 pieces).

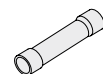





MANHATTAN XG2044

XG2044-__TRACK+LED+XM2044-T



Sistema modulare LED in alluminio estruso verniciato bianco, da incasso a scomparsa totale (trimless) per applicazioni in cartongesso. Oltre alla possibilità di installazione a parete e soffitto, in posizione orizzontale e verticale, si presta in modo particolare per installazioni perimetrali. Grazie alla riflessione della luce interna, il profilo non necessita di un diffusore.

Trimless modular LED system in extruded aluminum painted white for use in false ceiling. Besides the possibility of horizontal or vertical installation on walls and ceilings, this system is particularly suitable for perimeter installation. Due to the reflection of the internal light, this profile does not require a diffuser.

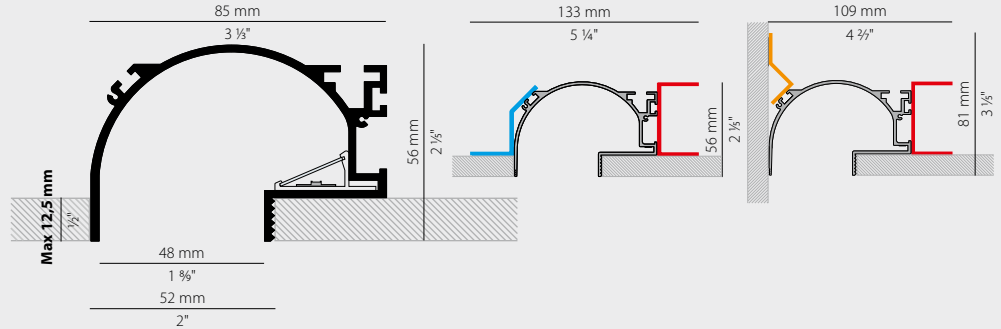

Electric options only with remote components page 303

Dimming / Power supply 303/304

Technical information 305

Wiring diagram 2-3 305

UGR <19 depending on installation conditions

Photometric data available at www.panzeri.it

TRIMLESS PROFILE

Fornito completo di supporto in alluminio per LED e schermo diffusore
Supplied with aluminium LED frame and diffuser

CODICE / CODE	L MM	L INCHES	NR. ADVISED	MM	INCHES	kg
XG2044-50TRACK	420	16 5/8"	2	425 x 58	16 3/4" x 2 3/8"	0,69
XG2044-100TRACK	920	36 1/4"	2	925 x 58	36 5/8" x 2 3/8"	1,38
XG2044-200TRACK	1920	75 3/8"	3	1925 x 58	75 5/8" x 2 3/8"	2,64
XG2044-300TRACK	2920	115"	4	2925 x 58	115 1/4" x 2 3/8"	4,13

LED MODULE



CODICE / CODE	L MM	L INCHES	MM	INCHES	W/M	LM/M	NR. LED	LED	V
YLR001.022.0110	5000	197"	50	2"	21,6W/m	3020lm/m	160/m	3000K Ra>80	24V DC
YLR002.017.0510	5000	197"	42	1 3/8"	17,3W/m	1700lm/m	168/m	2700K Ra>90	24V DC
YLR002.017.0410	5000	197"	42	1 3/8"	17,3W/m	1810lm/m	168/m	3000K Ra>90	24V DC
YLR002.017.0610	5000	197"	42	1 3/8"	17,3W/m	1920lm/m	168/m	4000K Ra>90	24V DC
YLR003.010.0510	5000	197"	42	1 3/8"	9,6W/m	882lm/m	168/m	2700K Ra>90	24V DC
YLR003.010.0410	5000	197"	42	1 3/8"	9,6W/m	930lm/m	168/m	3000K Ra>90	24V DC
YLR003.010.0610	5000	197"	42	1 3/8"	9,6W/m	980lm/m	168/m	4000K Ra>90	24V DC

Matrice di compatibilità LED / Profili pag. 233 / LED Profile Matrix page 233

**Eventuali tagli e saldature su rollina sono da quantificare a progetto.
Required cutting and welding on roll are to be calculated for each project.**

CODICI COLORI DISPONIBILI / COLOUR CODES AVAILABLE

- 01** bianco
white
- 21** foglia oro (a richiesta)
gold leaf (available on request)
- 23** foglia argento (a richiesta)
silver leaf (available on request)
- 24** foglia rame (a richiesta)
copper leaf (available on request)





XM2044-U90 1

Elemento di collegamento per due linee di profili componibili con angolo di giunzione piano esterno di 90°, per installazione incassata a scomparsa.
Connection joint for two lines of modular profiles with external level junction 90°, for total built-in installation.

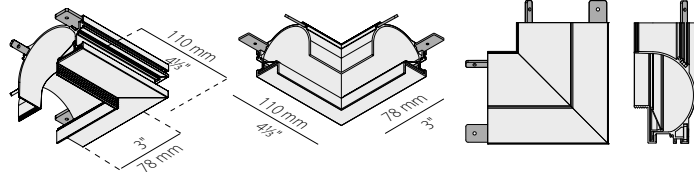

0,31

XM2044-U90 2

Elemento di collegamento per due linee di profili componibili con angolo di giunzione piano interno di 90°, per installazione incassata a scomparsa.
Connection joint for two lines of modular profiles with internal level junction 90°, for total built-in installation.

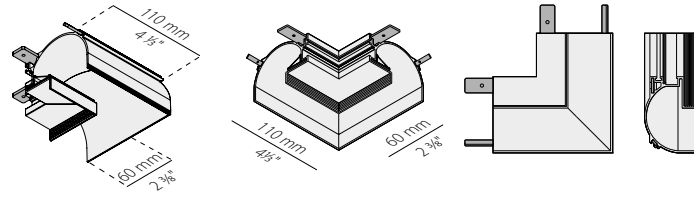

0,27

XM2044-ANG 3

Elemento di collegamento per due linee di profili componibili con angolo di giunzione perpendicolare interno di 90°, per installazione incassata a scomparsa.
Connection joint for two lines of modular profiles with internal perpendicular junction 90°, for total built-in installation.

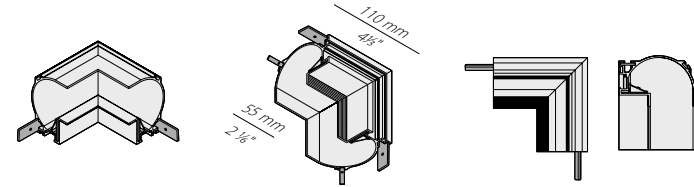

0,35

XM2044-ANG 4

Elemento di collegamento per due linee di profili componibili con angolo di giunzione perpendicolare esterno di 90°, per installazione incassata a scomparsa.
Connection joint for two lines of modular profiles with external perpendicular junction 90°, for total built-in installation.

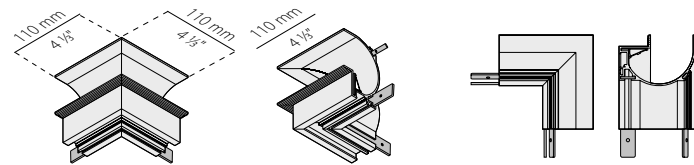

0,31

XM2044-U

Kit di giunzione lineare.
Linear junction kit.

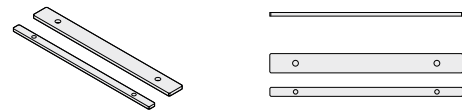

0,45

XM2044-TA

Vano per alimentazione con viti da fissare sulle giunzioni.
Power compartment with screws for installation on junctions.

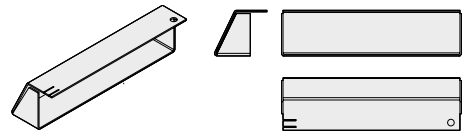

0,11

XM2044-T

Coppia di testate di chiusura con viti.
Pair of end caps with screws.



0,03

XM2044-F

Kit di staffe di fissaggio su cartongesso.
Drywall fixing bracket kit.



0,06

XM2044-FP

Kit di staffe di fissaggio filo parete.
Flush wall fixing bracket kit.



0,05

XM2044-P

Piastrina per appendimento.
Plate for hanging.



0,02

XM2044-CUT

Taglio lineare per moduli dritti.
Linear cut for straight modules.

In considerazione della particolare forma del prodotto e delle eventuali sfumature di colore lungo e tra gli elementi del sistema XG2044, si evidenzia che è cura dell'installatore abbinare i pezzi adiacenti in modo da ottenere più uniformità possibile di colore. Nessuna responsabilità è imputabile al produttore.

Given the particular shape of the product and the eventual colour shades along and between the elements of system XG2044, please note that the installer has the responsibility to match the adjacent pieces so as to obtain the best colour uniformity. The manufacturer does not accept any liability.

XM2044-U
Giunzione lineare
Linear junction

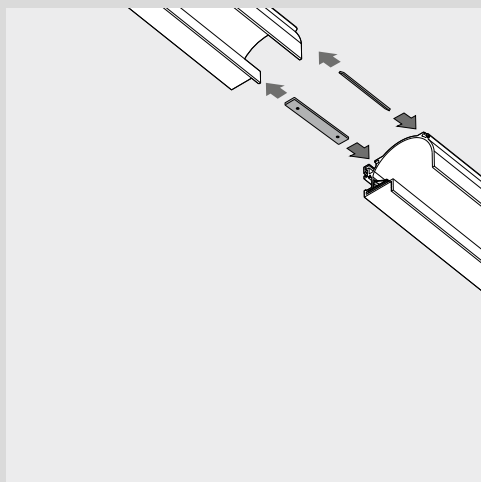

XM2044-U90 1
Angolo 1 piano 90° parete-parete / soffitto-soffitto misure esterne 110x110mm
Angle 1 horizontal 90° wall-wall / ceiling-ceiling, external measurements 110x110mm

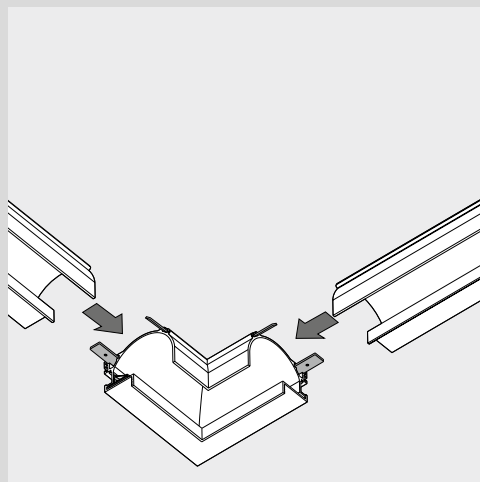

XM2044-U90 2
Angolo 2 piano 90° parete-parete / soffitto-soffitto misure esterne 110x110mm
Angle 2 horizontal 90° wall-wall / ceiling-ceiling, external measurements 110x110mm

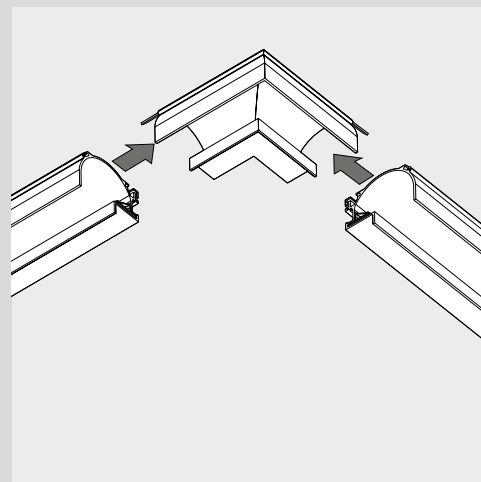

XM2044-ANG 3
Angolo 3 verticale 90° parete-soffitto/parete-parete misure esterne 110x110mm
Angle 3 vertical 90° wall-ceiling / wall-wall, external measurements 110x110mm

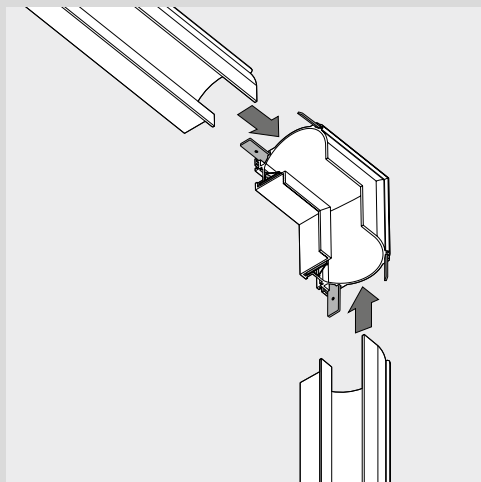

XM2044-ANG 4
Angolo 4 orizzontale 90° parete-parete misure esterne 110x110mm
Angle 4 horizontal 90° wall-wall, external measurements 110x110mm

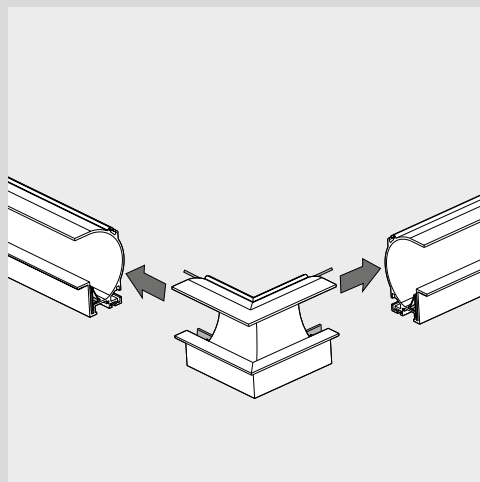

XM2044-TA
Vano alimentazione (opzionale) con viti da fissare sulla giunzione
Power compartment (optional) with screws for installation on the junction

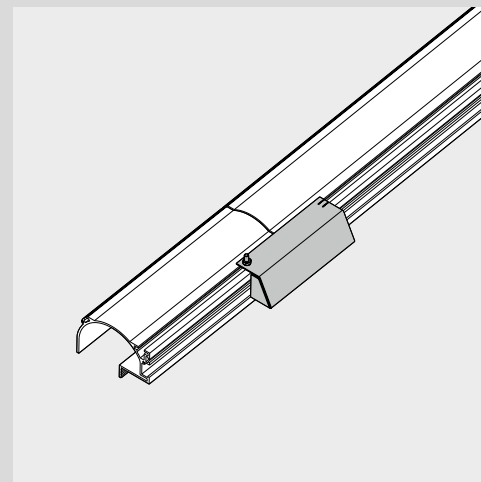

ESEMPI DI INSTALLAZIONE / INSTALLATION EXAMPLE

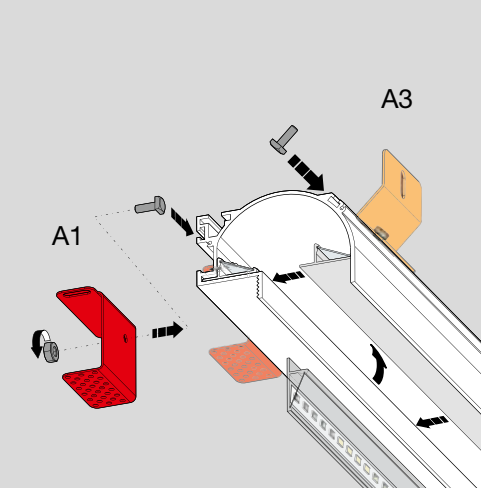
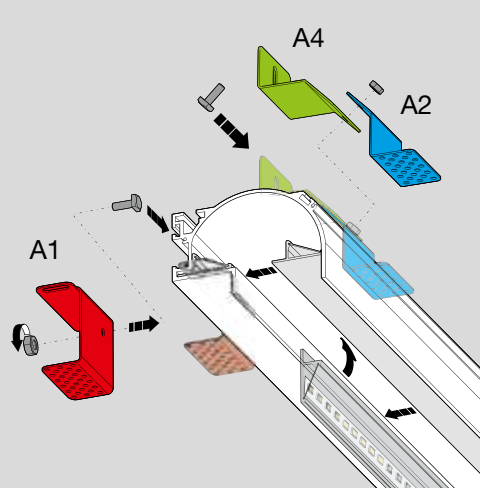
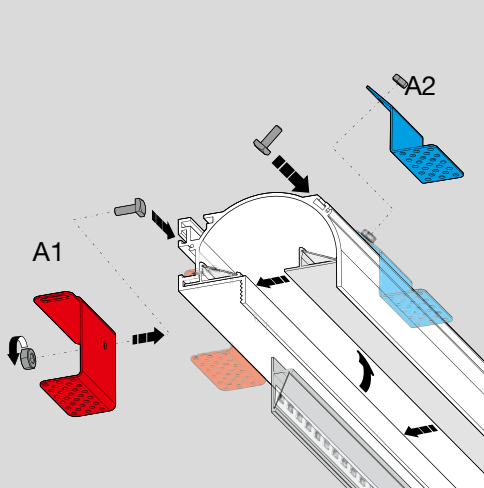

NOLITA
 XG238 XG38E XG2038

NOLITA TRIM
 XG239 XG39E XG2039

NOLITA OUT
 XP238 XP38E XP2038

XG238/38E_+LED+DIFFUSER+XM2038-T



XG239/39E_+LED+DIFFUSER+XM2039-T



XP238/38E_+LED+DIFFUSER+XM2038-T1

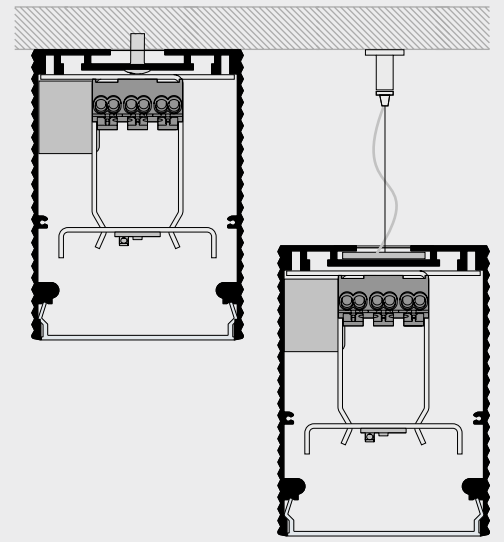
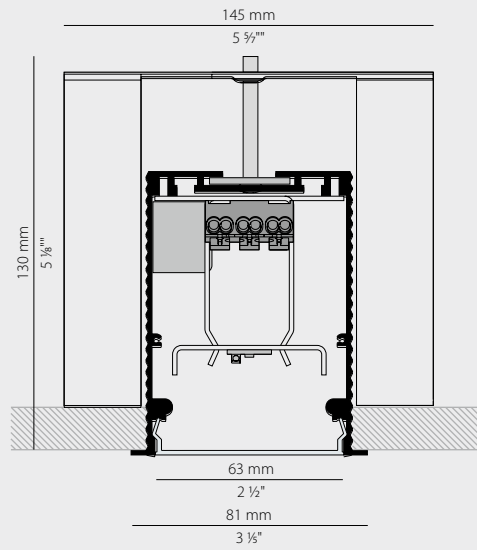
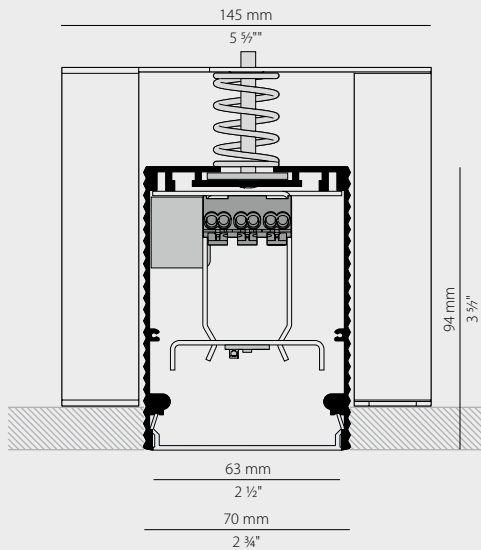

Sistema modulare LED, in alluminio estruso verniciato bianco disponibile in varie misure, da incasso a scomparsa totale (trimless), per applicazioni in verticale o orizzontale per cartongesso/laterizio. Per una corretta e facile installazione nel cartongesso sono disponibili farfalle micro regolabili opzionali. Doppi schermi: il primo monosuo per rasatura, stuccatura e verniciatura, il secondo definitivo in policarbonato o microprismato. Completo di driver e LED. Su richiesta le versioni con emergenza integrata. Predisporre, se necessari, eventuali appendimenti.

Modular LED system, painted white, in extruded aluminum available in various sizes, trimless, for vertical or horizontal installation in drywall / brick. For a correct and easy installation in false ceiling adjustable micro wing nuts are available (optional). Two screens: the first disposable for shaving, plastering and painting, the second definitive in polycarbonate or microprismatic. Complete with drivers and LED. On request version with integrated emergency. Prepare any suspensions, if necessary.

Sistema modulare LED, in alluminio estruso verniciato bianco disponibile in varie misure, da incasso con bordo (trim), per applicazioni in verticale o orizzontale per cartongesso/laterizio. Per una corretta e facile installazione nel cartongesso sono disponibili farfalle regolabili opzionali. Diffusori in policarbonato o microprismato. Completo di driver e LED. Su richiesta le versioni con emergenza integrata. Predisporre, se necessari, eventuali appendimenti.

Modular LED system, painted white in extruded aluminum, available in various sizes, trim, for vertical or horizontal installation in drywall / brick. For a correct and easy installation in false ceiling adjustable wing nuts are available (optional). Diffuser in polycarbonate or microprismatic. Complete with drivers and LED. On request version with integrated emergency. Prepare any suspensions, if necessary.

Sistema modulare LED in alluminio estruso verniciato bianco disponibile in varie misure da parete/plafone o a sospensione. Completa di driver e LED. Su richiesta le versioni con emergenza integrata.

Modular LED system painted white in extruded aluminum available in various sizes for wall / ceiling or suspension versions. Complete with drivers and LED. On request version with integrated emergency.

UGR < 19 depending on installation conditions

Photometric data available at www.panzeri.it

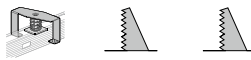

	CODICE / CODE	L MM	L INCHES	NR. ADVISED	MM	INCHES	W	LM	LED	V	EL	kg
Con LED ECO, driver e schermo monouso With LED ECO, driver and disposable screen	XG38E01.060.0401	591	23 3/8"	2	596 x 75	23 1/2" x 3"	16W	866lm	3000K Ra>90	220-240V AC	ON-OFF	1,82
	XG38E01.060.0402	591	23 3/8"	2	596 x 75	23 1/2" x 3"	16W	866lm	3000K Ra>90	220-240V AC	dimmable (DALI/ Push DIM)	1,82
	XG38E01.090.0401	891	35 1/8"	2	896 x 75	35 3/8" x 3"	22,5W	1299lm	3000K Ra>90	220-240V AC	ON-OFF	2,43
	XG38E01.090.0402	891	35 1/8"	2	896 x 75	35 3/8" x 3"	22,5W	1299lm	3000K Ra>90	220-240V AC	dimmable (DALI/ Push DIM)	2,43
	XG38E01.090.0407	891	35 1/8"	2	896 x 75	35 3/8" x 3"	22,5W	1299lm	3000K Ra>90	220-240V AC	emergency	2,43
	XG38E01.120.0401	1191	47"	2	1196 x 75	47 1/8" x 3"	29W	1732lm	3000K Ra>90	220-240V AC	ON-OFF	2,80
	XG38E01.120.0402	1191	47"	2	1196 x 75	47 1/8" x 3"	29W	1732lm	3000K Ra>90	220-240V AC	dimmable (DALI/ Push DIM)	2,80
	XG38E01.120.0407	1191	47"	2	1196 x 75	47 1/8" x 3"	29W	1732lm	3000K Ra>90	220-240V AC	emergency	2,80
	XG38E01.150.0401	1491	58 3/4"	2	1496 x 75	59" x 3"	35,5W	2166lm	3000K Ra>90	220-240V AC	ON-OFF	3,85
	XG38E01.150.0402	1491	58 3/4"	2	1496 x 75	59" x 3"	35,5W	2166lm	3000K Ra>90	220-240V AC	dimmable (DALI/ Push DIM)	3,85
XG38E01.150.0407	1491	58 3/4"	2	1496 x 75	59" x 3"	35,5W	2166lm	3000K Ra>90	220-240V AC	emergency	3,85	
Con LED, driver e schermo monouso With LED, driver and disposable screen	XG23801.060.0401	591	23 3/8"	2	596 x 75	23 1/2" x 3"	24,5W	1296lm	3000K Ra>90	220-240V AC	ON-OFF	1,82
	XG23801.060.0402	591	23 3/8"	2	596 x 75	23 1/2" x 3"	24,5W	1296lm	3000K Ra>90	220-240V AC	dimmable (DALI/ Push DIM)	1,82
	XG23801.090.0401	891	35 1/8"	2	896 x 75	35 3/8" x 3"	35W	1945lm	3000K Ra>90	220-240V AC	ON-OFF	2,43
	XG23801.090.0402	891	35 1/8"	2	896 x 75	35 3/8" x 3"	35W	1945lm	3000K Ra>90	220-240V AC	dimmable (DALI/ Push DIM)	2,43
	XG23801.090.0407	891	35 1/8"	2	896 x 75	35 3/8" x 3"	35W	1945lm	3000K Ra>90	220-240V AC	emergency	2,43
	XG23801.120.0401	1191	47"	2	1196 x 75	47 1/8" x 3"	46W	2592lm	3000K Ra>90	220-240V AC	ON-OFF	2,80
	XG23801.120.0402	1191	47"	2	1196 x 75	47 1/8" x 3"	46W	2592lm	3000K Ra>90	220-240V AC	dimmable (DALI/ Push DIM)	2,80
	XG23801.120.0407	1191	47"	2	1196 x 75	47 1/8" x 3"	46W	2592lm	3000K Ra>90	220-240V AC	emergency	2,80
	XG23801.150.0401	1491	58 3/4"	2	1496 x 75	59" x 3"	57W	3240lm	3000K Ra>90	220-240V AC	ON-OFF	3,85
XG23801.150.0402	1491	58 3/4"	2	1496 x 75	59" x 3"	57W	3240lm	3000K Ra>90	220-240V AC	dimmable (DALI/ Push DIM)	3,85	
Senza LED e driver, con schermo monouso. Sezionabile ogni 100 mm (4"). Without LED and driver, with disposable screen. Sectionable every 100 mm (4").	XG23801.J60.0099	591	23 3/8"	2	596 x 75	23 1/2" x 3"	max 38W/m			220-240V AC		1,32
Senza LED e driver, con schermo monouso Without LED and driver, with disposable screen	XG23801.060.0099	591	23 3/8"	2	596 x 75	23 1/2" x 3"	max 38W/m			220-240V AC		1,32
	XG23801.090.0099	891	35 1/8"	2	896 x 75	35 3/8" x 3"	max 38W/m			220-240V AC		2,08
	XG23801.120.0099	1191	47"	2	1196 x 75	47 1/8" x 3"	max 38W/m			220-240V AC		2,39
	XG23801.150.0099	1491	58 3/4"	2	1496 x 75	59" x 3"	max 38W/m			220-240V AC		3,40
	XG23801.240.0099	2382	93 5/8"	2	2387 x 75	94" x 3"	max 38W/m			220-240V AC		5,12



TRIM PROFILE



LED IP40 IP20 IK08 850°

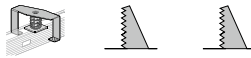

	CODICE / CODE	L MM	L INCHES	NR. ADVISED	MM	INCHES	W	LM	LED	V	EL	kg
Con LED ECO e driver With LED ECO and driver	XG39E01.060.0401	591	23 3/8"	2	596 x 75	23 1/2" x 3"	16W	866lm	3000K Ra>90	220-240V AC	ON-OFF	1,82
	XG39E01.060.0402	591	23 3/8"	2	596 x 75	23 1/2" x 3"	16W	866lm	3000K Ra>90	220-240V AC	dimnable (DALI/ Push DIM)	1,82
	XG39E01.090.0401	891	35 1/8"	2	896 x 75	35 3/8" x 3"	22,5W	1299lm	3000K Ra>90	220-240V AC	ON-OFF	2,43
	XG39E01.090.0402	891	35 1/8"	2	896 x 75	35 3/8" x 3"	22,5W	1299lm	3000K Ra>90	220-240V AC	dimnable (DALI/ Push DIM)	2,43
	XG39E01.120.0401	1191	47"	2	1196 x 75	47 1/8" x 3"	29W	1732lm	3000K Ra>90	220-240V AC	ON-OFF	2,80
	XG39E01.120.0402	1191	47"	2	1196 x 75	47 1/8" x 3"	29W	1732lm	3000K Ra>90	220-240V AC	dimnable (DALI/ Push DIM)	2,80
	XG39E01.150.0401	1491	58 3/4"	2	1496 x 75	59" x 3"	35,5W	2166lm	3000K Ra>90	220-240V AC	ON-OFF	3,85
	XG39E01.150.0402	1491	58 3/4"	2	1496 x 75	59" x 3"	35,5W	2166lm	3000K Ra>90	220-240V AC	dimnable (DALI/ Push DIM)	3,85
Con LED e driver With LED and driver	XG239Q1.060.0401	591	23 3/8"	2	596 x 75	23 1/2" x 3"	24,5W	1296lm	3000K Ra>90	220-240V AC	ON-OFF	1,82
	XG239Q1.060.0402	591	23 3/8"	2	596 x 75	23 1/2" x 3"	24,5W	1296lm	3000K Ra>90	220-240V AC	dimnable (DALI/ Push DIM)	1,82
	XG239Q1.090.0401	891	35 1/8"	2	896 x 75	35 3/8" x 3"	35W	1945lm	3000K Ra>90	220-240V AC	ON-OFF	2,43
	XG239Q1.090.0402	891	35 1/8"	2	896 x 75	35 3/8" x 3"	35W	1945lm	3000K Ra>90	220-240V AC	dimnable (DALI/ Push DIM)	2,43
	XG239Q1.120.0401	1191	47"	2	1196 x 75	47 1/8" x 3"	46W	2592lm	3000K Ra>90	220-240V AC	ON-OFF	2,80
	XG239Q1.120.0402	1191	47"	2	1196 x 75	47 1/8" x 3"	46W	2592lm	3000K Ra>90	220-240V AC	dimnable (DALI/ Push DIM)	2,80
	XG239Q1.150.0401	1491	58 3/4"	2	1496 x 75	59" x 3"	57W	3240lm	3000K Ra>90	220-240V AC	ON-OFF	3,85
	XG239Q1.150.0402	1491	58 3/4"	2	1496 x 75	59" x 3"	57W	3240lm	3000K Ra>90	220-240V AC	dimnable (DALI/ Push DIM)	3,85
Senza LED e driver. Sezionabile ogni 100 mm (4"). Without LED and driver. Sectionable every 100 mm (4").	XG239Q1.J60.0099	591	23 3/8"	2	596 x 75	23 1/2" x 3"	max 38W/m			220-240V AC		1,32
Senza LED e driver Without LED and driver	XG239Q1.060.0099	591	23 3/8"	2	596 x 75	23 1/2" x 3"	max 38W/m			220-240V AC		1,32
	XG239Q1.090.0099	891	35 1/8"	2	896 x 75	35 3/8" x 3"	max 38W/m			220-240V AC		2,08
	XG239Q1.120.0099	1191	47"	2	1196 x 75	47 1/8" x 3"	max 38W/m			220-240V AC		2,39
	XG239Q1.150.0099	1491	58 3/4"	2	1496 x 75	59" x 3"	max 38W/m			220-240V AC		3,40
	XG239Q1.240.0099	2382	93 5/8"	2	2387 x 75	94" x 3"	max 38W/m			220-240V AC		5,12

CEILING SUSPENSION



LED IP40 IK08 850°

	CODICE / CODE	L MM	L INCHES	W	LM	LED	V	EL	kg
Con LED ECO e driver With LED ECO and driver	XP38E01.060.0401	591	23 3/8"	16W	866lm	3000K Ra>90	220-240V AC	ON-OFF	1,48
	XP38E01.060.0402	591	23 3/8"	16W	866lm	3000K Ra>90	220-240V AC	dimnable (DALI/ Push DIM)	1,48
	XP38E01.090.0401	891	35 1/8"	22,5W	1299lm	3000K Ra>90	220-240V AC	ON-OFF	1,61
	XP38E01.090.0402	891	35 1/8"	22,5W	1299lm	3000K Ra>90	220-240V AC	dimnable (DALI/ Push DIM)	1,61
	XP38E01.120.0401	1191	47"	29W	1732lm	3000K Ra>90	220-240V AC	ON-OFF	2,65
	XP38E01.120.0402	1191	47"	29W	1732lm	3000K Ra>90	220-240V AC	dimnable (DALI/ Push DIM)	2,65
	XP38E01.150.0401	1491	58 3/4"	35,5W	2166lm	3000K Ra>90	220-240V AC	ON-OFF	3,69
	XP38E01.150.0402	1491	58 3/4"	35,5W	2166lm	3000K Ra>90	220-240V AC	dimnable (DALI/ Push DIM)	3,69

	CODICE / CODE	L MM	L INCHES	W	LM	LED	V	EL	kg
Con LED e driver With LED and driver	XP23801.060.0401	591	23 3/8"	24,5W	1296lm	3000K Ra>90	220-240V AC	ON-OFF	1,48
	XP23801.060.0402	591	23 3/8"	24,5W	1296lm	3000K Ra>90	220-240V AC	dimmbable (DALI/ Push DIM)	1,48
	XP23801.090.0401	891	35 1/8"	35W	1945lm	3000K Ra>90	220-240V AC	ON-OFF	1,61
	XP23801.090.0402	891	35 1/8"	35W	1945lm	3000K Ra>90	220-240V AC	dimmbable (DALI/ Push DIM)	1,61
	XP23801.120.0401	1191	47"	46W	2592lm	3000K Ra>90	220-240V AC	ON-OFF	2,65
	XP23801.120.0402	1191	47"	46W	2592lm	3000K Ra>90	220-240V AC	dimmbable (DALI/ Push DIM)	2,65
	XP23801.150.0401	1491	58 3/4"	57W	3240lm	3000K Ra>90	220-240V AC	ON-OFF	3,69
	XP23801.150.0402	1491	58 3/4"	57W	3240lm	3000K Ra>90	220-240V AC	dimmbable (DALI/ Push DIM)	3,69

CODICI COLORI DISPONIBILI / COLOUR CODES AVAILABLE

01 bianco
white

DIFFUSERS

	CODICE / CODE	L MM	L INCHES		kg
	XM2038/39-60S	591 x 63	23 3/8" x 2 1/2"	Schermo diffusore in policarbonato estruso con finitura opalina, di lunghezza 591mm (23,3"). Extruded polycarbonate diffuser with opaline finish, 591mm (23,3") long.	0,10
	XM2038/39-90S	891 x 63	35 1/8" x 2 1/2"	Schermo diffusore in policarbonato estruso con finitura opalina, di lunghezza 891mm (35,1"). Extruded polycarbonate diffuser with opaline finish, 891mm (35,1") long.	0,13
	XM2038/39-120S	1191 x 63	47" x 2 1/2"	Schermo diffusore in policarbonato estruso con finitura opalina, di lunghezza 1191mm (46,9"). Extruded polycarbonate diffuser with opaline finish, 1191mm (46,9") long.	0,18
	XM2038/39-150S	1491 x 63	58 3/4" x 2 1/2"	Schermo diffusore in policarbonato estruso con finitura opalina, di lunghezza 1491mm (58,7"). Extruded polycarbonate diffuser with opaline finish, 1491mm (58,7") long.	0,22
	XM2038/39-260S	2600 x 63	102 4/8" x 2 1/2"	Schermo diffusore in policarbonato estruso con finitura opalina, di lunghezza 2600mm (102,4"). Extruded polycarbonate diffuser with opaline finish, 2600mm (102,4") long.	0,38
	XM2038/39-380S	3800 x 63	149 5/8" x 2 1/2"	Schermo diffusore in policarbonato estruso con finitura opalina, di lunghezza 3800mm (149,6"). Extruded polycarbonate diffuser with opaline finish, 3800mm (149,6") long.	0,56
	XM2038/39-60S PR	591 x 63	23 3/8" x 2 1/2"	Schermo diffusore in policarbonato estruso microprismatico, di lunghezza 591mm (23,3"). Micro-prismatic extruded polycarbonate diffuser, 591mm (23,3") long.	0,10
	XM2038/39-90S PR	891 x 63	35 1/8" x 2 1/2"	Schermo diffusore in policarbonato estruso microprismatico, di lunghezza 891mm (35,1"). Micro-prismatic extruded polycarbonate diffuser, 891mm (35,1") long.	0,13
	XM2038/39-120S PR	1191 x 63	47" x 2 1/2"	Schermo diffusore in policarbonato estruso microprismatico, di lunghezza 1191mm (46,9"). Micro-prismatic extruded polycarbonate diffuser, 1191mm (46,9") long.	0,18
	XM2038/39-150S PR	1491 x 63	58 3/4" x 2 1/2"	Schermo diffusore in policarbonato estruso microprismatico, di lunghezza 1491mm (58,7"). Micro-prismatic extruded polycarbonate diffuser, 1491mm (58,7") long.	0,22
	XM2038/39-260S PR	2600 x 63	102 4/8" x 2 1/2"	Schermo diffusore in policarbonato estruso microprismatico, di lunghezza 2600mm (102,4"). Micro-prismatic extruded polycarbonate diffuser, 2600mm (102,4") long.	0,38
	XM2038/39-380S PR	3800 x 63	149 5/8" x 2 1/2"	Schermo diffusore in policarbonato estruso microprismatico, di lunghezza 3800mm (149,6"). Micro-prismatic extruded polycarbonate diffuser, 3800mm (149,6") long.	0,56

Lo schermo può essere tagliato, su richiesta servizio taglio
The screen can be cut, on request cutting service

XG38E01.X60.0401

2,58

Elemento di collegamento per quattro linee di profili componibili con angolo di giunzione piano di 60°/120°, per installazione incassata a soffitto o parete in ambienti interni, con emissione diretta.

Connection joint for four lines of modular profiles with 60°/120° level junction, for ceiling or wall built-in installation for interiors, with direct light emission.

Potenza assorbita apparecchio / Luminaire power consumption 16W

Flusso luminoso apparecchio / Luminaire luminous flux 866lm

3000K Ra>90 220-240V AC ON-OFF

Fornito completo di LED ECO, driver e schermo monouso

Supplied with LED ECO, driver and disposable screen

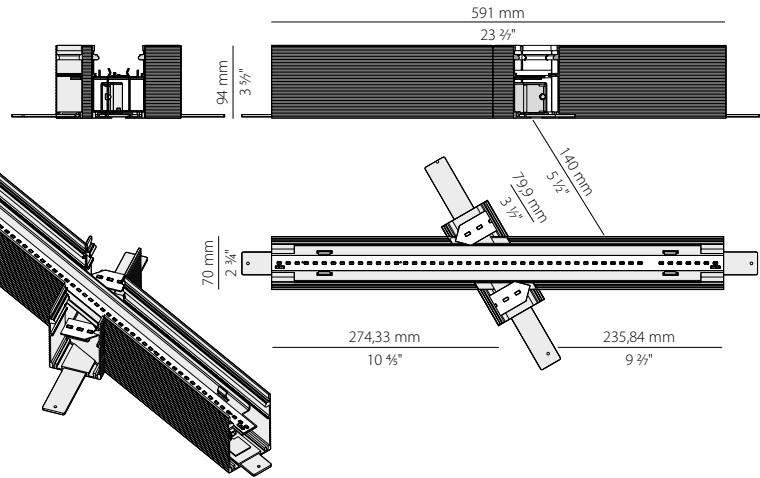
**XG38E01.X60.0402**

2,58

Elemento di collegamento per quattro linee di profili componibili con angolo di giunzione piano di 60°/120°, per installazione incassata a soffitto o parete in ambienti interni, con emissione diretta.

Connection joint for four lines of modular profiles with 60°/120° level junction, for ceiling or wall built-in installation for interiors, with direct light emission.

Potenza assorbita apparecchio / Luminaire power consumption 16W

Flusso luminoso apparecchio / Luminaire luminous flux 866lm

3000K Ra>90 220-240V AC Dimmable (DALI/Push DIM)

Fornito completo di LED ECO, driver e schermo monouso

Supplied with LED ECO, driver and disposable screen

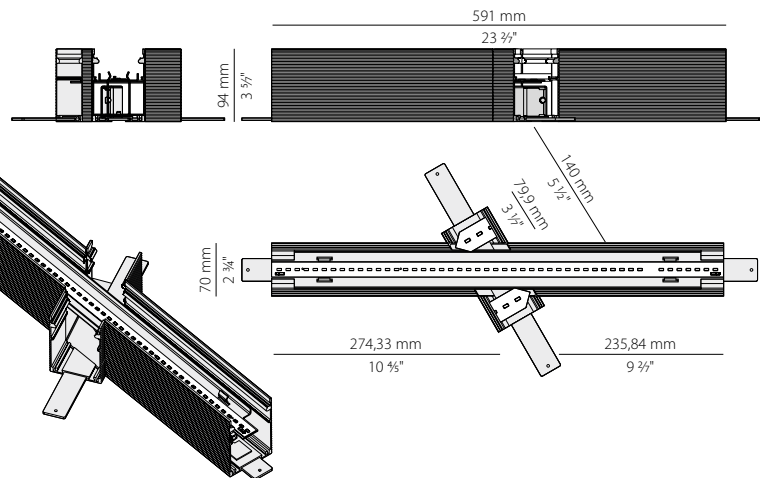
**XG23801.X60.0401**

2,58

Elemento di collegamento per quattro linee di profili componibili con angolo di giunzione piano di 60°/120°, per installazione incassata a soffitto o parete in ambienti interni, con emissione diretta.

Connection joint for four lines of modular profiles with 60°/120° level junction, for ceiling or wall built-in installation for interiors, with direct light emission.

Potenza assorbita apparecchio / Luminaire power consumption 24,5W

Flusso luminoso apparecchio / Luminaire luminous flux 1296lm

3000K Ra>90 220-240V AC ON-OFF

Fornito completo di LED, driver e schermo monouso

Supplied with LED, driver and disposable screen

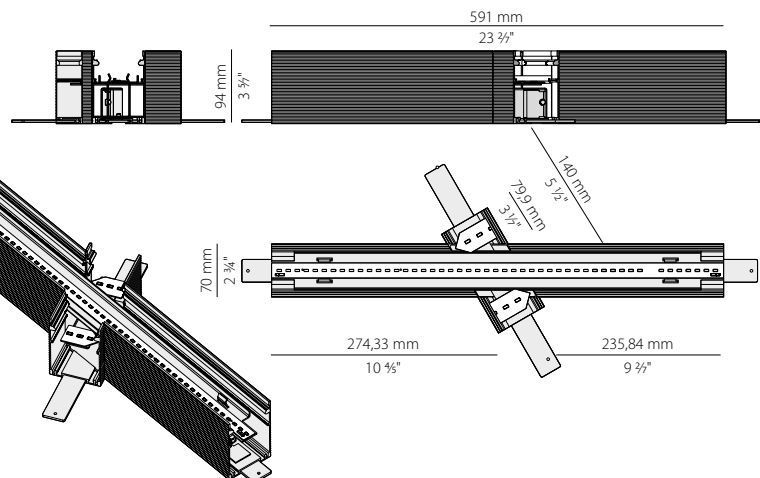

XG23801.X60.0402

2,58

Elemento di collegamento per quattro linee di profili componibili con angolo di giunzione piano di 60°/120°, per installazione incassata a soffitto o parete in ambienti interni, con emissione diretta.

Connection joint for four lines of modular profiles with 60°/120° level junction, for ceiling or wall built-in installation for interiors, with direct light emission.

Potenza assorbita apparecchio / Luminaire power consumption 24,5W
Flusso luminoso apparecchio / Luminaire luminous flux 1296lm
3000K Ra>90 220-240V AC Dimmable (DALI/Push DIM)

Fornito completo di LED, driver e schermo monouso
Supplied with LED, driver and disposable screen

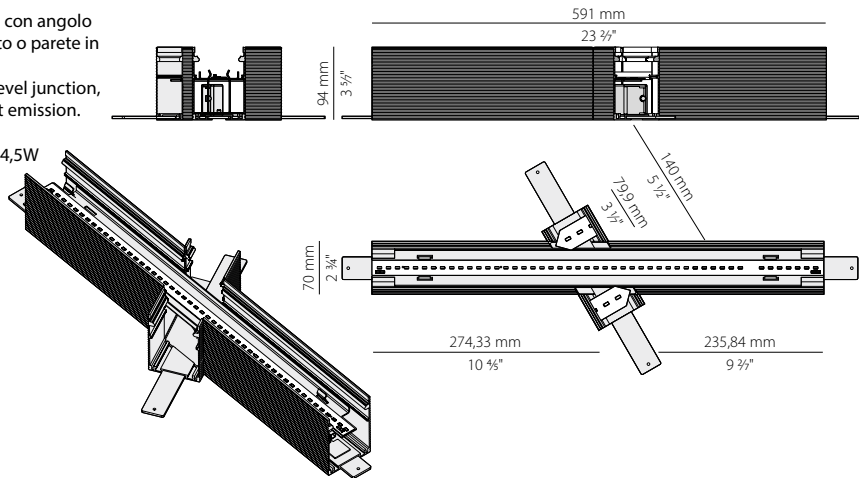
**XG38E01.L90.0402**

Elemento di collegamento per due linee di profili componibili con angolo di giunzione piano di 90°, per installazione incassata a soffitto o parete in ambienti interni, con emissione diretta.

Connection joint for two lines of modular profiles with 90° level junction, for ceiling or wall built-in installation for interiors, with direct light emission.

Potenza assorbita apparecchio / Luminaire power consumption 16W
Flusso luminoso apparecchio / Luminaire luminous flux 866lm
3000K Ra>90 220-240V AC Dimmable (DALI/Push DIM)

Fornito completo di LED ECO, driver e schermo monouso
Supplied with LED ECO, driver and disposable screen

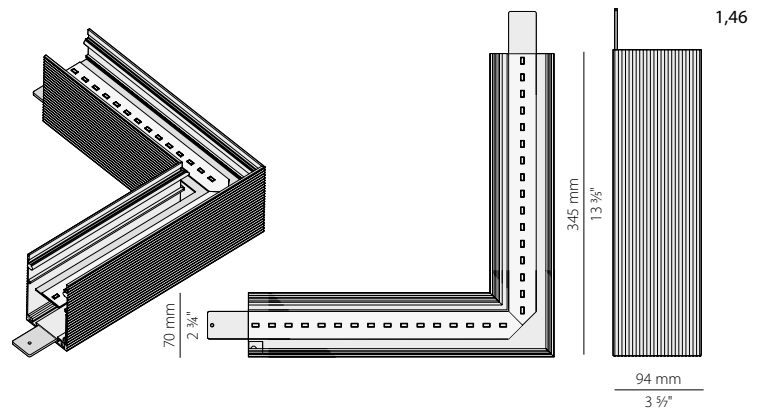
**XG23801.L90.0402**

Elemento di collegamento per due linee di profili componibili con angolo di giunzione piano di 90°, per installazione incassata a soffitto o parete in ambienti interni, con emissione diretta.

Connection joint for two lines of modular profiles with 90° level junction, for ceiling or wall built-in installation for interiors, with direct light emission.

Potenza assorbita apparecchio / Luminaire power consumption 24,5W
Flusso luminoso apparecchio / Luminaire luminous flux 1296lm
3000K Ra>90 220-240V AC Dimmable (DALI/Push DIM)

Fornito completo di LED, driver e schermo monouso
Supplied with LED, driver and disposable screen

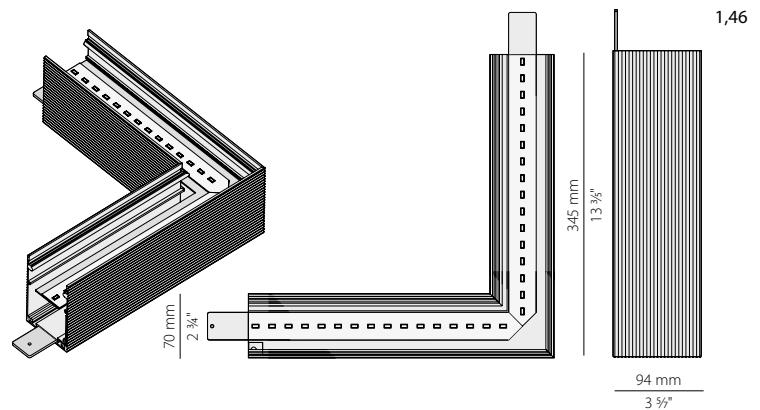
**XG39E01.L90.0402**

Elemento di collegamento per due linee di profili componibili con angolo di giunzione piano di 90°, per installazione incassata a soffitto o parete in ambienti interni, con emissione diretta.

Connection joint for two lines of modular profiles with 90° level junction, for ceiling or wall built-in installation for interiors, with direct light emission.

Potenza assorbita apparecchio / Luminaire power consumption 16W
Flusso luminoso apparecchio / Luminaire luminous flux 866lm
3000K Ra>90 220-240V AC Dimmable (DALI/Push DIM)

Fornito completo di LED ECO e driver
Supplied with LED ECO and driver

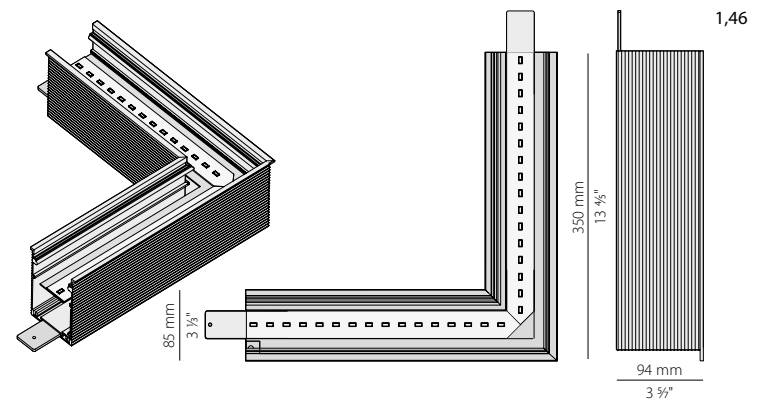

XG23901.L90.0402

Elemento di collegamento per due linee di profili componibili con angolo di giunzione piano di 90°, per installazione incassata a soffitto o parete in ambienti interni, con emissione diretta.

Connection joint for two lines of modular profiles with 90° level junction, for ceiling or wall built-in installation for interiors, with direct light emission.

Potenza assorbita apparecchio / Luminaire power consumption 24,5W

Flusso luminoso apparecchio / Luminaire luminous flux 1296lm

3000K Ra>90 220-240V AC Dimmable (DALI/Push DIM)

Fornito completo di LED e driver

Supplied with LED and driver

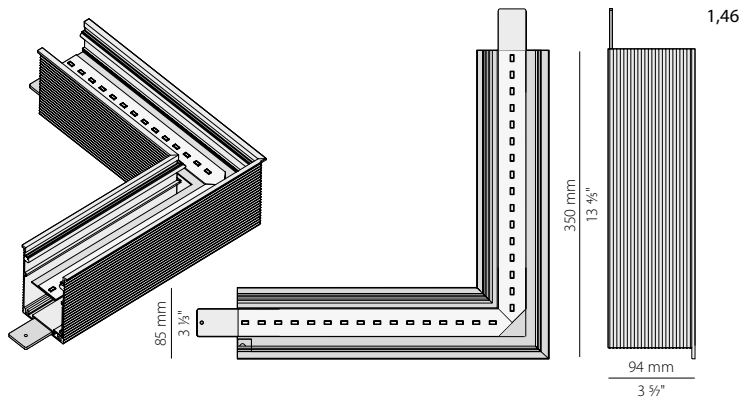
**XP38E01.L90.0402**

Elemento di collegamento per due linee di profili componibili con angolo di giunzione piano di 90°, per installazione a sospensione o a soffitto in ambienti interni, con emissione diretta.

Connection joint for two lines of modular profiles with 90° level junction, for suspended or ceiling installation for interiors, with direct light emission.

Potenza assorbita apparecchio / Luminaire power consumption 16W

Flusso luminoso apparecchio / Luminaire luminous flux 866lm

3000K Ra>90 220-240V AC Dimmable (DALI/Push DIM)

Fornito completo di LED ECO e driver

Supplied with LED ECO and driver

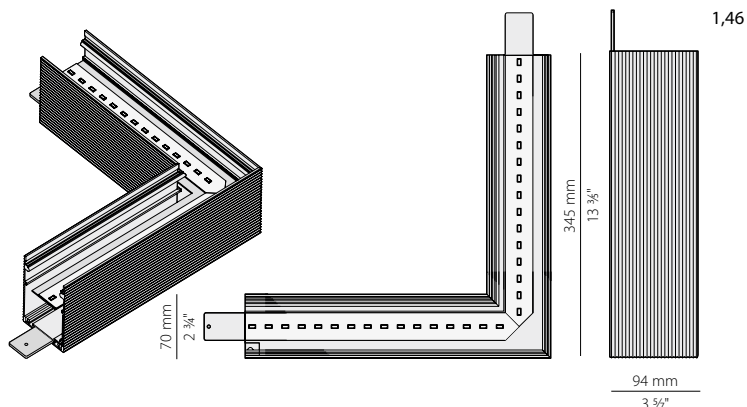
**XP23801.L90.0402**

Elemento di collegamento per due linee di profili componibili con angolo di giunzione piano di 90°, per installazione a sospensione o a soffitto in ambienti interni, con emissione diretta.

Connection joint for two lines of modular profiles with 90° level junction, for suspended or ceiling installation for interiors, with direct light emission.

Potenza assorbita apparecchio / Luminaire power consumption 24,5W

Flusso luminoso apparecchio / Luminaire luminous flux 1296lm

3000K Ra>90 220-240V AC Dimmable (DALI/Push DIM)

Fornito completo di LED e driver

Supplied with LED and driver

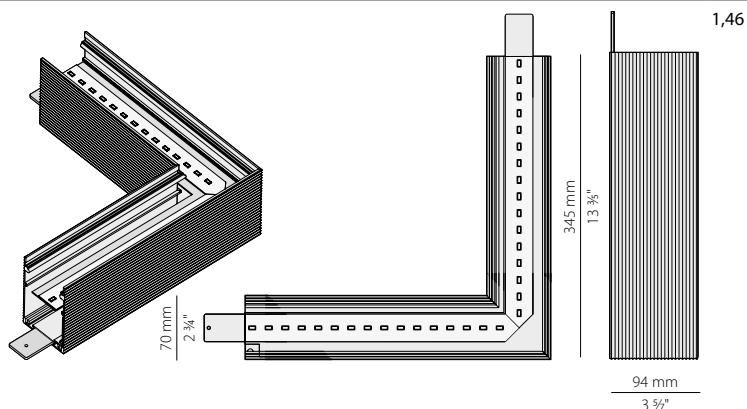
**XG23801.L90.0401**

Elemento di collegamento per due linee di profili componibili con angolo di giunzione piano di 90°, per installazione incassata a soffitto o parete in ambienti interni, con emissione diretta.

Connection joint for two lines of modular profiles with 90° level junction, for ceiling or wall built-in installation for interiors, with direct light emission.

Potenza assorbita apparecchio / Luminaire power consumption 5W

Flusso luminoso apparecchio / Luminaire luminous flux 126lm

3000K Ra>90 220-240V AC ON-OFF

Fornito completo di LED, driver e schermo monouso

Supplied with LED, driver and disposable screen

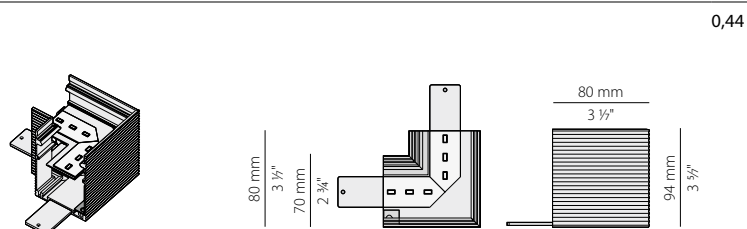
**XG23901.L90.0401**

Elemento di collegamento per due linee di profili componibili con angolo di giunzione piano di 90°, per installazione incassata a soffitto o parete in ambienti interni, con emissione diretta.

Connection joint for two lines of modular profiles with 90° level junction, for ceiling or wall built-in installation for interiors, with direct light emission.

Potenza assorbita apparecchio / Luminaire power consumption 5W

Flusso luminoso apparecchio / Luminaire luminous flux 126lm

3000K Ra>90 220-240V AC ON-OFF

Fornito completo di LED e driver

Supplied with LED and driver

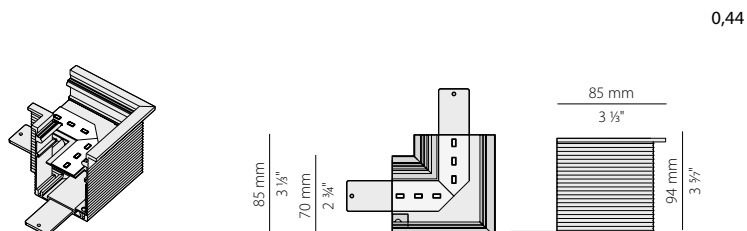

XP23801.L90.0401

0,44

Elemento di collegamento per due linee di profili componibili con angolo di giunzione piano di 90°, per installazione a sospensione o a soffitto in ambienti interni, con emissione diretta.

Connection joint for two lines of modular profiles with 90° level junction, for suspended or ceiling installation for interiors, with direct light emission.

Potenza assorbita apparecchio / Luminaire power consumption 5W
Flusso luminoso apparecchio / Luminaire luminous flux 126lm
3000K Ra>90 220-240V AC ON-OFF

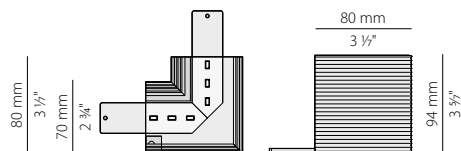
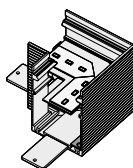

Fornito completo di LED e driver
Supplied with LED and driver

XG23801.T90.0401

0,36

Elemento di collegamento per tre linee di profili componibili con angolo di giunzione piano a "T", con emissione diretta.

Connection joint for three lines of modular profiles with "T" level junction, with direct light emission.

Potenza assorbita apparecchio / Luminaire power consumption 5W
Flusso luminoso apparecchio / Luminaire luminous flux 126lm
3000K Ra>90 220-240V AC ON-OFF

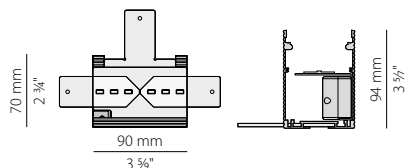
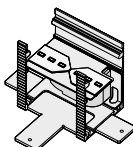

Fornito completo di LED e driver
Supplied with LED and driver

XG23800.X90.0401

0,30

Elemento di collegamento per quattro linee di profili componibili con angolo di giunzione piano a "X", con emissione diretta.

Connection joint for four lines of modular profiles with "X" level junction, with direct light emission.

Potenza assorbita apparecchio / Luminaire power consumption 4W
Flusso luminoso apparecchio / Luminaire luminous flux 63lm
3000K Ra>90 220-240V AC ON-OFF

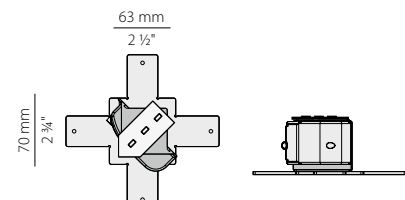
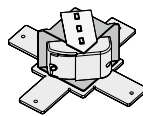

Fornito completo di LED e driver
Supplied with LED and driver

XM2038-U90

0,38

Elemento di collegamento per due linee di profili componibili con angolo di giunzione piano di 90°, per installazione incassata a scomparsa.

Connection joint for two lines of modular profiles with level junction 90°, for total built-in installation.

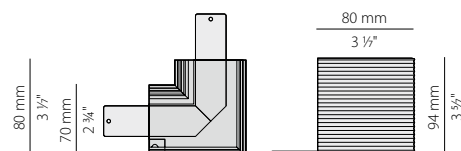
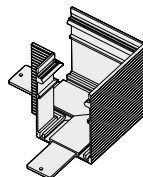
**XM2039-U90**

0,31

Elemento di collegamento per due linee di profili componibili con angolo di giunzione piano di 90°, per installazione incassata.

Connection joint for two lines of modular profiles with level junction 90°, for built-in installation.

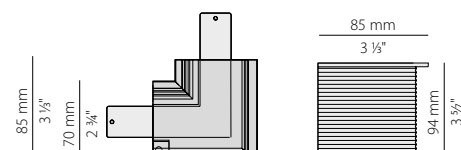
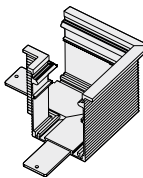
**XM2038-U90 XP**

0,29

Elemento di collegamento per due linee di profili componibili con angolo di giunzione piano di 90°, per installazione a sospensione o a soffitto.

Connection joint for two lines of modular profiles with level junction 90°, for suspended or ceiling installation.

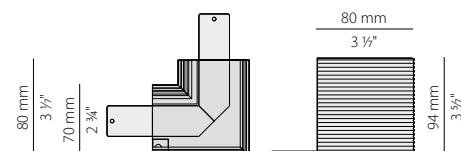
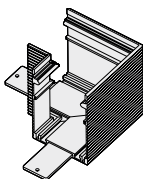
**XM2038-UT**

0,30

Elemento di collegamento per tre linee di profili componibili con angolo di giunzione piano a "T".

Connection joint for three lines of modular profiles with "T" level junction.

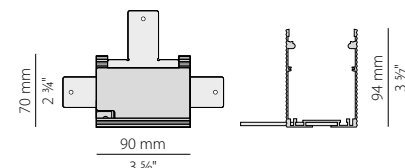
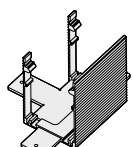
**XM2038-X**

0,13

Giunzione piana per quattro profili a "X".

Four profiles "X" level junction.

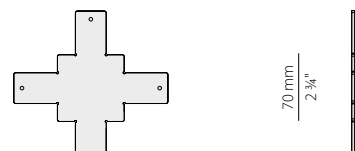
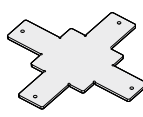

ACCESSORI / ACCESSORIES

kg

XM2038/39-ANG

Giunzione perpendicolare per due profili con taglio a 45°.
Two profiles perpendicular junction with 45° cut.

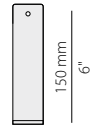

0,21

XM2038/39-U

Giunzione lineare.
Linear junction.

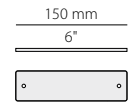

0,08

XM2038-T

Coppia di testate di chiusura con viti per profili incassati a scomparsa.
Pair of end caps with screws for trimless recessed profiles.

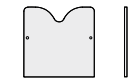
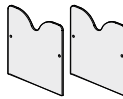

0,38

XM2039-T

Coppia di testate di chiusura con viti per profili incassati.
Pair of end caps with screws for recessed profiles.

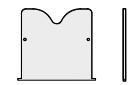
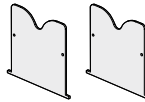

0,04

XM2038-T1

Coppia di testate di chiusura con viti per profili installati a sospensione o a soffitto.
Pair of end caps with screws for suspended or ceiling mounted profiles.

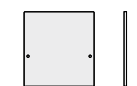
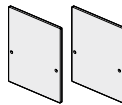

0,56

XM2038-F

Farfalla di fissaggio su cartongesso per profili incassati a scomparsa.
Drywall fixing bracket for trimless recessed profiles.

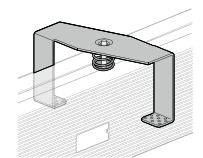

0,12

XM2039-F

Farfalla di fissaggio su cartongesso per profili incassati.
Drywall fixing bracket for recessed profiles.

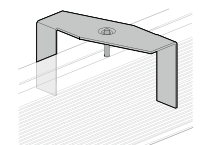

0,10

XM2038/39-L

Coppia di piastrine di fissaggio per l'incasso in muratura.
Pair of fixing plates for recessed installation in brick walls or concrete.



0,06

XM2033/34/38/39P

Piastrina per appendimento.
Plate for hanging.



0,01

XM-KIT-S

Kit di sospensione singolo.
Single suspension kit.



0,05

XM2038-A

Coppia di copriluce adesivi per giunzioni.
Pair of adhesive light covers for junctions.

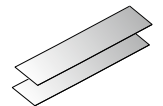

XM2038/46-3

Kit di alimentazione con rosone bianco, cavo di alimentazione a 3 poli di lunghezza 2,2m (86,6").
Power supply kit with white canopy, 3 pole power cable with length 2,2m (86,6").

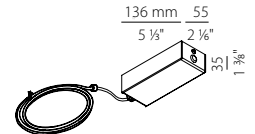

0,45

XM2038/46-5

Kit di alimentazione con rosone bianco, cavo di alimentazione a 5 poli di lunghezza 2,2m (86,6").
Power supply kit with white canopy, 5 pole power cable with length 2,2m (86,6").

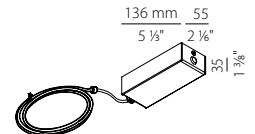

0,56

XM2038-ALU CUT

Taglio a richiesta di estruso di alluminio.
Extruded aluminum cut on request.

XM2038-SCREEN CUT

Taglio a richiesta di schermo in policarbonato.
Polycarbonate screen cut on request.



BROADWAY XP248

XP248__+LED+XM24801.202.0099



Profilo da parete/soffitto, sezionabile in alluminio estruso mm 2000 completo di diffusore in policarbonato.

Wall/ceiling cuttable profile in extruded aluminium supplied with polycarbonate diffuser.

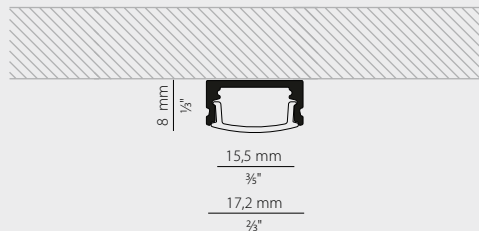

Electric options only with remote components	page 303
Dimming / Power supply	303/304
Technical information	305
Wiring diagram 2	305
Photometric data available at www.panzeri.it	

CEILING / WALL PROFILE



	CODICE / CODE	L MM	L INCHES	kg
Fornito completo di schermo diffusore Supplied with diffuser	XP24801.200.0099	2000	78 1/8"	0,27

LED MODULE



	CODICE / CODE	L MM	L INCHES	MM	INCHES	W/M	LM/M	NR. LED	LED	V
	YLR002.017.0510	5000	197"	42	1 3/8"	17,3W/m	1700lm/m	168/m	2700K Ra>90	24V DC
	YLR002.017.0410	5000	197"	42	1 3/8"	17,3W/m	1810lm/m	168/m	3000K Ra>90	24V DC
	YLR002.017.0610	5000	197"	42	1 3/8"	17,3W/m	1920lm/m	168/m	4000K Ra>90	24V DC
	YLR003.010.0510	5000	197"	42	1 3/8"	9,6W/m	882lm/m	168/m	2700K Ra>90	24V DC
	YLR003.010.0410	5000	197"	42	1 3/8"	9,6W/m	930lm/m	168/m	3000K Ra>90	24V DC
	YLR003.010.0610	5000	197"	42	1 3/8"	9,6W/m	980lm/m	168/m	4000K Ra>90	24V DC

Matrice di compatibilità LED / Profili pag. 233 / LED Profile Matrix page 233

CODICI COLORI DISPONIBILI / COLOUR CODES AVAILABLE

01 bianco
white

ACCESSORI / ACCESSORIES

XM24801.202.0099
Coppia di testate di chiusura.
Pair of end caps.



XM24800.201.0099
Coppia di clip di fissaggio.
Pair of fixing clips.

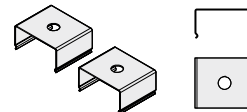



NOOK XP250

XP250_+LED+XM25001.202.0099



Profilo per installazione angolare, pensato per il montaggio in corrispondenza degli spigoli formati da due pareti o da parete e soffitto, oppure per applicazione sotto mensole e pensili. Modulo sezionabile, in alluminio estruso di lunghezza 2000mm completo di diffusore in policarbonato.

Profile for corner perimetral installation, designed to be installed at the edge of two walls or one wall and the ceiling, or alternatively as an application underneath shelves and cabinets. The profile can be cut on the project site, and is made of extruded aluminum 2000mm in length supplied with a opal polycarbonate diffuser.

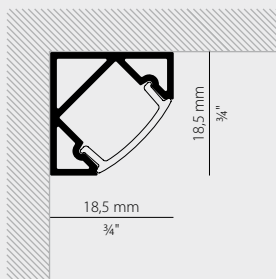

Electric options only with remote components	page 303
Dimming / Power supply	303/304
Technical information	305
Wiring diagram 2	305
Photometric data available at www.panzeri.it	

CEILING /WALL PROFILE

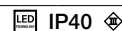

	CODICE / CODE	L MM	L INCHES	kg
Fornito completo di schermo diffusore Supplied with diffuser	XP25001.200.0099	2000	78 3/8"	

LED MODULE



	CODICE / CODE	L MM	L INCHES	MM	INCHES	W/M	LM/M	NR. LED	LED	V
	YLR002.017.0510	5000	197"	42	1 2/3"	17,3W/m	1700lm/m	168/m	2700K Ra>90	24V DC
	YLR002.017.0410	5000	197"	42	1 2/3"	17,3W/m	1810lm/m	168/m	3000K Ra>90	24V DC
	YLR002.017.0610	5000	197"	42	1 2/3"	17,3W/m	1920lm/m	168/m	4000K Ra>90	24V DC
	YLR003.010.0510	5000	197"	42	1 2/3"	9,6W/m	882lm/m	168/m	2700K Ra>90	24V DC
	YLR003.010.0410	5000	197"	42	1 2/3"	9,6W/m	930lm/m	168/m	3000K Ra>90	24V DC
	YLR003.010.0610	5000	197"	42	1 2/3"	9,6W/m	980lm/m	168/m	4000K Ra>90	24V DC

Matrice di compatibilità LED / Profili pag. 233 / LED Profile Matrix page 233

CODICI COLORI DISPONIBILI / COLOUR CODES AVAILABLE

01 bianco
white

ACCESSORI / ACCESSORIES

kg

XM25001.202.0099

Coppia di testate di chiusura.
Pair of end caps.

XM25000.201.0099

Coppia di clip di fissaggio.
Pair of fixing clips.



TRIBECA XG249

XP249_+_LED+XM24901.202.0099



Profilo con bordo (trim) in alluminio estruso sezionabile, 2000mm completo di diffusore in policarbonato, da incasso per applicazioni in verticale o orizzontale.

Cutttable profile with border (trim) in extruded aluminium 2000mm complete of polycarbonate diffuser, recessed for vertical or horizontal use.

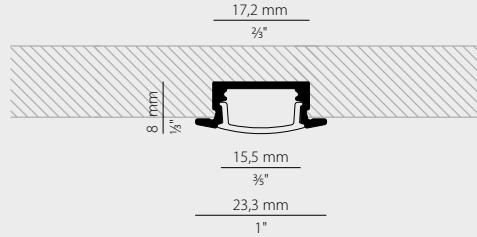

Electric options only with remote components	page 303
Dimming / Power supply	303/304
Technical information	305
Wiring diagram 2	305
Photometric data available at www.panzeri.it	

TRIM PROFILE

	CODICE / CODE	L MM	L INCHES	MM	INCHES	kg
Fornito completo di schermo diffusore Supplied with diffuser	XG24901.200.0099	2000	78 1/2"	2000 x 17	78 1/2" x 3/8"	0,31

LED MODULE

	CODICE / CODE	L MM	L INCHES	MM	INCHES	W/M	LM/M	NR. LED	LED	V
	YLR002.017.0510	5000	197"	42	1 3/8"	17,3W/m	1700lm/m	168/m	2700K Ra>90	24V DC
	YLR002.017.0410	5000	197"	42	1 3/8"	17,3W/m	1810lm/m	168/m	3000K Ra>90	24V DC
	YLR002.017.0610	5000	197"	42	1 3/8"	17,3W/m	1920lm/m	168/m	4000K Ra>90	24V DC
	YLR003.010.0510	5000	197"	42	1 3/8"	9,6W/m	882lm/m	168/m	2700K Ra>90	24V DC
	YLR003.010.0410	5000	197"	42	1 3/8"	9,6W/m	930lm/m	168/m	3000K Ra>90	24V DC
	YLR003.010.0610	5000	197"	42	1 3/8"	9,6W/m	980lm/m	168/m	4000K Ra>90	24V DC

Matrice di compatibilità LED / Profili pag. 233 / LED Profile Matrix page 233

CODICI COLORI DISPONIBILI / COLOUR CODES AVAILABLE

01 bianco
white

ACCESSORI / ACCESSORIES

XM24901.202.0099
Coppia di testate di chiusura.
Pair of end caps.



VADEMECUM PROFILI / PROFILE HANDBOOK

GIUNZIONI DISPONIBILI / AVAILABLE JOINTS						
MODELLO / MODEL	GIUNZIONE / JOINT					
	LINEARE/LINEAR	90°	T	X	ANG. VERTICALI/VERTICAL ANGLE	SPECIALI / SPECIAL
XG2033	•	•	•	•	•	•
XP2033	•	•				
XG2034	•				•	
XG2044	•	•				
XG2045	•	•			•	
XG231 / XG232	•	•			•	
XG238 / XG38E	•	•	•*	•*	•	60/120
XP238 / XP38E	•	•	•*	•*		
XG239 / XP39E	•				•	
XP246	•					
XG247	•	•				
XP248	•					
XG249	•					
XP250	•					
XG251	•					
XG270	•					
XG271 / XG272 / XG273	•					

* Solo versione ON/OFF / ON/OFF version only

MATRICE LED/PROFILO / LED PROFILE MATRIX									
MODELLO / MODEL	XM003	XM005	XM006	YLR001	YLR002	YLR003	YLR004	YLR101	YLR102
XG2033			•	•	•	•	•		
XP2033			•	•	•	•	•		
XG2034			•	•	•	•	•		
XG2044			•	•	•	•	•		
XG2045			•	•	•	•	•		
XG231 / XG232	•								
XG238 / XG38E									
XP238 / XP38E									
XG239 / XP39E									
XP246			•	•	•	•	•		
XG247		•							
XP248				•	•	•	•		
XG249				•	•	•	•		
XP250				•	•	•	•		
XG251				•	•	•	•		
XG270								•	•
XG271 / XG272 / XG273								•	•

INFORMAZIONI LED / LED SPECIFICATION					
MODELLO / MODEL	POTENZA (W/m) POWER (W/m)	FLUSSO LUMINOSO (lm/m) LUMINOUS FLUX (lm/m)	DIVISIBILE OGNI (mm) CUT EVERY (mm)	LED/m	LUNGHEZZA (mm) / LENGHT (mm)
XM005	17,2	2280	62,5	128	500/125
XM006	17,2	2280	62,5	128	500/125
YLR001	21,6	3020	50	160	5000
YLR002	17	1700 - 1810 - 1920	42	168	5000
YLR003	10	882 - 930 - 980	42	168	5000
YLR004	14,4	1585	50	160	5000
YLR101	10,6	401	50		1000
YLR102	10,6	401	50		5000

DIMENSIONI E POSSIBILITÀ DI TAGLIO / DIMENSIONS AND CUT CONFIGURATION						
MODELLO / MODEL	DIMENSIONI STANDARD / STANDARD DIMENSIONS				TAGLIABILE / CUTTABLE	
XG2033	510	1010	2010	3010	•	
XP2033	525	1025	2025	3025	•	
XG2034	510	1010	2010	3010	•	
XG2044	420	920	1920	2920	•	
XG2045	510	1010	2010	3010	•	
XG238 / XG38E	591	891	1191	1491	XG23901.J60.0099	
XP238 / XP38E	591	891	1191	1491		
XG239 / XP39E	591	891	1191	1491	XG23801.J60.0099	
XP246	515	1015	2015	3015	•	
XG247	510	1010	2010	3010	•	
XP248	2000				•	
XG249	2000				•	
XP250	2000				•	
XG251	1010	2010	3010		•	
XG270	500	1000	2000	3000	•	

ANGOLI / ANGLE U90-1/U90-2

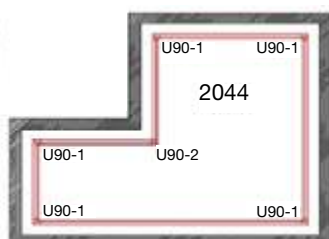

La luce nella configurazione standard è rivolta principalmente verso la parete

With standard configuration light is mainly oriented towards the wall

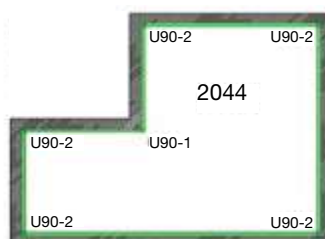

La luce nella configurazione standard è rivolta principalmente verso il centro della stanza

With standard configuration light is mainly oriented towards the center of room

PROIETTORI / SPOTLIGHT

235	ASTORIA 5
240	ASTORIA IN
238	ASTORIA LINE
242	ASTORIA OUT
239	ASTORIA SPOT
245	JACKIE SPOT
250	QUEENS
249	QUEENS 10
248	QUEENS 20
247	QUEENS 25
246	QUEENS 45
257	SOHO IN
256	SOHO LINE
259	SOHO OUT
254	SOHO 5
253	SOHO 10
252	SOHO 20
255	SOHO S 15



ASTORIA 5



Proiettore orientabile in pressofusione di alluminio con LED ad alta efficienza e adattatore integrato, per binario elettrificato a bassissima tensione 48V. Completo di cilindro antiabbagliamento e lente con fascio medio in materiale termoplastico. Disponibile in versione 2700K e 3000K, in finitura bianco, nero, ottone satinato, bronzo e titanio, con braccio e coperchio posteriore in colore nero.

Die-cast aluminium adjustable spotlight with high efficiency LED and integrated adapter for 48V low voltage electrified track. Complete with anti-glare snoot and thermoplastic medium-beam lens. Available in 2700K and 3000K version, in white, black, mat brass, bronze and titanium finishes, with black arm and back cover.

NOVELTY	CODICE CODE	FONTI LUMINOSE LIGHT SOURCES	kg
	B43201.005.1719	Potenza assorbita apparecchio / Luminaire power consumption 7,5W	
	B43202.005.1719	Flusso luminoso apparecchio / Luminaire luminous flux 530lm	
	B43217.005.1719	2700K Ra>90 24° 48V DC dimmable (DALI)	
	B43219.005.1719	IP20	
	B43230.005.1719		
	B43201.005.2519	Potenza assorbita apparecchio / Luminaire power consumption 7,5W	
	B43202.005.2519	Flusso luminoso apparecchio / Luminaire luminous flux 530lm	
	B43217.005.2519	3000K Ra>90 24° 48V DC dimmable (DALI)	
	B43219.005.2519	IP20	
	B43230.005.2519		

Fotometrie disponibili www.panzeri.it / Photometric data available at www.panzeri.it

CODICI COLORI DISPONIBILI / COLOUR CODES AVAILABLE

- 01** bianco white
- 02** nero black
- 17** bronzo bronze
- 19** ottone satinato mat brass
- 30** titanio titanium









ASTORIA LINE



Modulo lineare a luce diffusa per binario elettrificato a bassissima tensione 48V per applicazioni soffitto/ parete, sospensione e incasso, con corpo in alluminio in colore nero e schermo in policarbonato estruso opale. Possibilità di dimmerazione tramite protocollo DALI.

Linear LED module for 48V low voltage electrified track, for ceiling/wall, suspended or recessed applications. Black aluminium body, opal diffuser made in extruded polycarbonate. Possibility of dimming with DALI protocol.

NOVELTY	CODICE CODE	FONTI LUMINOSE LIGHT SOURCES	kg
	B43102.060.0519	Potenza assorbita apparecchio / Luminaire power consumption 11,4W Flusso luminoso apparecchio / Luminaire luminous flux 2700K Ra>90 48V DC dimmable (DALI) IP20	
	B43102.060.0419	Potenza assorbita apparecchio / Luminaire power consumption 11,4W Flusso luminoso apparecchio / Luminaire luminous flux 3000K Ra>90 48V DC dimmable (DALI) IP20	

Fotometrie disponibili www.panzeri.it / Photometric data available at www.panzeri.it

CODICI COLORI DISPONIBILI / COLOUR CODES AVAILABLE

02 nero
black





ASTORIA SPOT

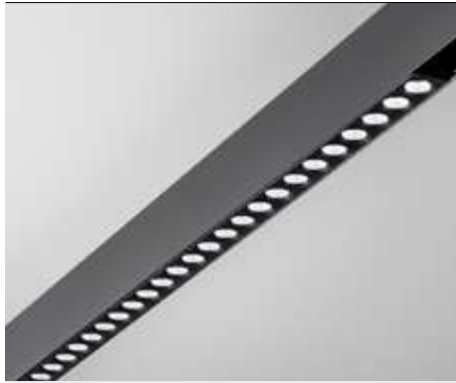

Modulo di luce lineare per binario elettrificato a bassissima tensione 48V per applicazioni soffitto/parete, sospensione e incasso, disponibile in due diverse lunghezze. Corpo in alluminio in colore nero, lenti con fascio 30° in policarbonato e copertura in materiale plastico. Possibilità di dimmerazione tramite protocollo DALI.

Linear LED module for 48V low voltage electrified track, for ceiling/wall, suspended or recessed applications, available in two different lengths. Black aluminium body, 30° beam polycarbonate lens and plastic cover. Possibility of dimming with DALI protocol.

NOVELTY

CODICE CODE

FONTI LUMINOSE LIGHT SOURCES

kg

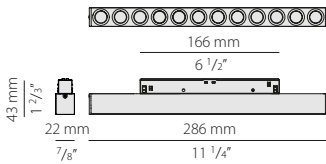

B43002.030.1719

Potenza assorbita apparecchio / Luminaire power consumption 5,7W
Flusso luminoso apparecchio / Luminaire luminous flux 2700K Ra>90 30° 48V DC dimmable (DALI)

LED IP20

B43002.030.2519

Potenza assorbita apparecchio / Luminaire power consumption 5,7W
Flusso luminoso apparecchio / Luminaire luminous flux 3000K Ra>90 30° 48V DC dimmable (DALI)

LED IP20

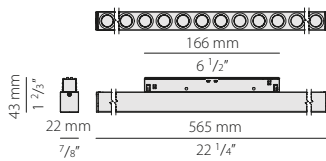

B43002.060.1719

Potenza assorbita apparecchio / Luminaire power consumption 10,6W
Flusso luminoso apparecchio / Luminaire luminous flux 2700K Ra>90 30° 48V DC dimmable (DALI)

LED IP20

B43002.060.2519

Potenza assorbita apparecchio / Luminaire power consumption 10,6W
Flusso luminoso apparecchio / Luminaire luminous flux 3000K Ra>90 30° 48V DC dimmable (DALI)

LED IP20

Fotometrie disponibili www.panzeri.it / Photometric data available at www.panzeri.it

CODICI COLORI DISPONIBILI / COLOUR CODES AVAILABLE

02 nero
black

ASTORIA IN



Sistema di binari a bassissima tensione 48V per applicazioni ad incasso. Binario a sezione rettangolare in alluminio estruso anodizzato nero, predisposto per alloggiare i proiettori e i moduli luminosi provvisti di adattatore 48V. Possibilità di regolazione DALI. Disponibile un'ampia varietà di accessori e giunti di collegamento.

System of 48V low voltage electrified tracks for recessed applications. Square-shaped track made of black anodised extruded aluminium, suitable to host spotlights and linear light modules equipped with 48V adapters. Possibility of DALI dimming. Wide range of available accessories and joints.

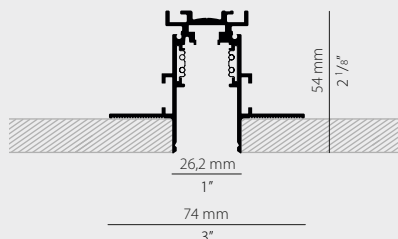

NOVELTY

TRIMLESS RECESSED ELECTRIFIED TRACK 48V DC

IP20 850°

CODICE / CODE	L MM	L INCHES	kg
9500-2/B-ST5-E	2000	78 7/8"	

CODICI COLORI DISPONIBILI / COLOUR CODES AVAILABLE

02 nero
black

ACCESSORI / ACCESSORIES

S-9500-L/B-2000

Copertura di protezione per installazione binario elettrificato a incasso.
Protective cover for recessed electrified track installation.

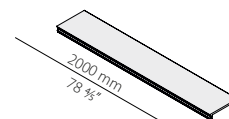

S-9500/LE-B-3000

Copertura estetica per binario elettrificato 48V DC.
Aesthetic cover for 48V DC electrified track.

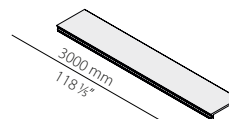

9501-S/B-E

Alimentazione di testa per binario elettrificato 48V DC DALI.
Head power supply for 48V DC DALI electrified track.

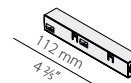

S-9500/314-B

Giunzione lineare senza contatti per binario elettrificato a incasso 48V DC.
Linear mechanical junction for recessed electrified 48V DC track.

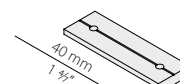

9503-S/B-E

Giunto lineare elettrificato per binario 48V DC DALI.
Linear electrified joint for 48V DC DALI track.

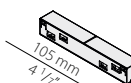

S-9511/B-ST5

Giunzione meccanica a "L" per binario elettrificato 48V DC a incasso senza bordo.
Mechanical "L" joint for 48V DC recessed trimless electrified track.

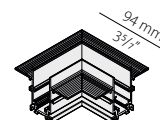

9511/B-E

Giunto elettrificato a "L" per binario 48V DC DALI.
Electrified "L" joint for 48V DC DALI track.

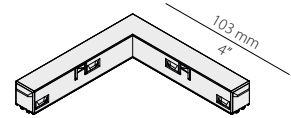
**S-9511-I/B-ST5**

Giunzione meccanica a "L" interna parete/soffitto per binario elettrificato 48V DC a incasso senza bordo.
Internal wall/ceiling "L" joint for 48V DC recessed trimless electrified track.

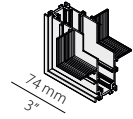
**9518-S/B-E**

Giunto elettrificato flessibile per binario 48V DC DALI.
Flexible electrified joint for 48V DC DALI track.

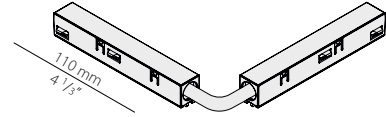
**9504/ST2-B**

Testata di chiusura per binario elettrificato 48V DC, senza foro.
End cap for 48V DC electrified track, without power supply hole.

**9504/ST2-B-F**

Testata di chiusura per binario elettrificato 48V DC, con foro.
End cap for 48V DC electrified track, with power supply hole.

**S-9000-P4**

Kit sospensione per binario ad incasso con tige rigida di lunghezza 1000mm (39,4").
Suspension kit with rigid tige 1000mm (39,4") long for recessed track.

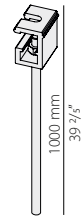
**S-9000/118**

Clip per fissaggio rapido con tenditore per tige rigida di sospensione.
Clip for quick fastening with turnbuckle for rigid suspension tige.

**YBE41002.DV1**

Alimentatore integrato per binario elettrificato 48V DC, 100W, DALI.
Integrated 100W power supply for electrified 48V DALI track.

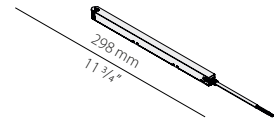
**YRS.B048.A16**

Dispositivo ripetitore per optoisolare il bus data, per binario elettrificato 48V DC DALI.

ACCESSORIO OBBLIGATORIO

Repeater device for opto-isolating the data bus, for 48V DC DALI electrified track.

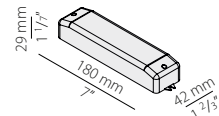
MANDATORY ACCESSORY**YDV.048.075.A01**

Alimentatore LED, 75W 48V DC, on/off.
LED driver, 75W 48V DC, on/off.

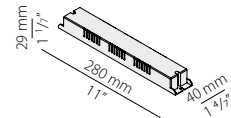
**YDV.048.150.A01**

Alimentatore LED, 150W 48V DC, on/off.
LED driver, 150W 48V DC, on/off.

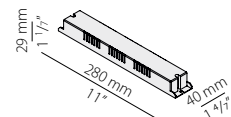

ASTORIA OUT



Sistema di binari a bassissima tensione 48V per installazioni a soffitto/parete o sospensione. Binario a sezione rettangolare in alluminio estruso anodizzato nero, predisposto per alloggiare i proiettori e i moduli luminosi provvisti di adattatore 48V. Possibilità di regolazione DALI. Disponibile un'ampia varietà di accessori e giunti di collegamento.

System of 48V low voltage electrified tracks for ceiling/wall or suspended applications. Square-shaped track made of black anodised extruded aluminium, suitable to host spotlights and linear light modules equipped with 48V adapters. Possibility of DALI dimming. Wide range of available accessories and joints.

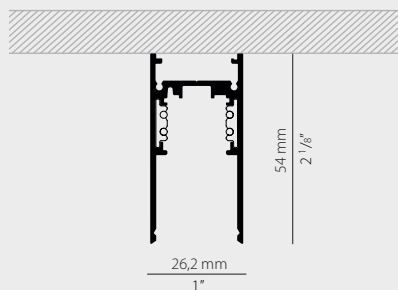

NOVELTY

ELECTRIFIED TRACK 48V DC 

IP20 850° 

CODICE / CODE	L MM	L INCHES	kg
9500-2/B-ST2-E	2000mm	78 4/5"	

CODICI COLORI DISPONIBILI / COLOUR CODES AVAILABLE

02 nero
black

ACCESSORI / ACCESSORIES

S-9500/LE-B-3000

Copertura estetica di lunghezza 3000mm (118,1") per binario elettrificato 48V DC.
Aesthetic cover for 48V DC electrified track, length 3000mm (118.1").

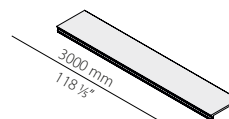

9501-S/B-E

Alimentazione di testa per binario elettrificato 48V DC DALI.
Head power supply for 48V DC DALI electrified track.

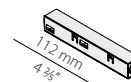

S-9500/323-SV

Giunzione lineare per binario elettrificato a sospensione o plafone.
Linear junction for suspended or ceiling-mounted electrified track.

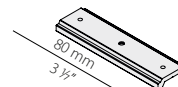

9503-S/B-E

Giunto lineare elettrificato per binario 48V DC DALI.
Linear electrified joint for 48V DC DALI track.

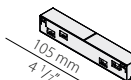

S-9511/B-ST2

Giunzione a "L" per binario elettrificato 48V DC a sospensione o plafone.
"L" junction for 48V DC suspended or ceiling-mounted electrified track.

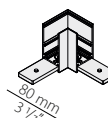

9511/B-E

Giunto elettrificato a "L" per binario 48V DC DALI.
Electrified "L" joint for 48V DC DALI track.

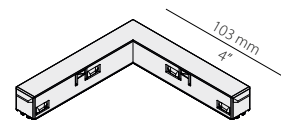



ACCESSORI / ACCESSORIES

kg

9518-S/B-E

Giunto elettrificato flessibile per binario 48V DC DALI.
Flexible electrified joint for 48V DC DALI track.

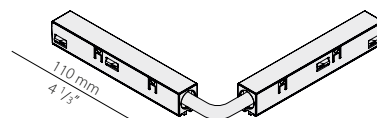

9504/ST2-B

Testata di chiusura per binario elettrificato 48V DC, senza foro.
End cap for 48V DC electrified track, without power supply hole.



9504/ST2-B-F

Testata di chiusura per binario elettrificato 48V DC, con foro.
End cap for 48V DC electrified track, with power supply hole.



S-9500/114-B

Kit per attacco a soffitto per binario elettrificato 48V DC.
Ceiling mounting kit for 48V DC electrified track.



9500-KIT1-3

Kit sospensione per estremità, con fune di acciaio di lunghezza 3000mm (118,1"), per binario elettrificato.
End suspension kit, with 3000mm (118.1") long steel wire, for electrified track.

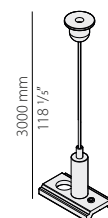

9500-KIT2-3

Kit fissaggio e giunzione per binario elettrificato a sospensione, con fune di acciaio di lunghezza 3000mm (118,1").
Fixing and junction kit, with 3000mm (118.1") long steel wire, for suspended electrified track.

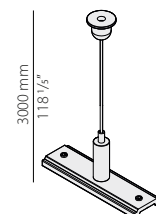

9500/P-100E-B-SP-N

Kit di alimentazione con rosone per binario elettrificato a sospensione, con driver 100W/48V e testata di alimentazione.

Power supply kit with canopy for electrified suspended track, with 100W/48V driver and power supply head.

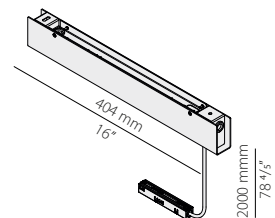
**9500/P-100E-B-C1-N**

Kit di alimentazione con rosone per binario elettrificato a plafone, con driver 100W/48V e testata di alimentazione.

Power supply kit with canopy for ceiling-mounted electrified track, with 100W/48V driver and power supply head.

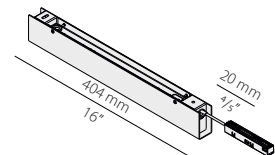
**YBE41002.DV1**

Alimentatore integrato per binario elettrificato 48V DC, 100W, DALI.

Integrated 100W power supply for electrified 48V DALI track.

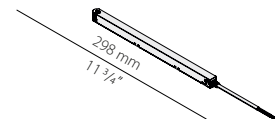
**YRS.B048.A16**

Dispositivo ripetitore per optoisolare il bus data, per binario elettrificato 48V DC DALI.

ACCESSORIO OBBLIGATORIO

Repeater device for opto-isolating the data bus, for 48V DC DALI electrified track.

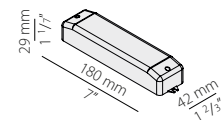
MANDATORY ACCESSORY**YDV.048.075.A01**

Alimentatore LED, 75W 48V DC, on/off.

LED driver, 75W 48V DC, on/off.

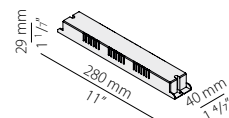
**YDV.048.150.A01**

Alimentatore LED, 150W 48V DC, on/off.

LED driver, 150W 48V DC, on/off.

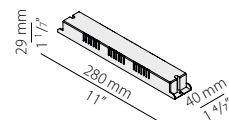



JACKIE SPOT

Enzo Panzeri 2015

Registered Design

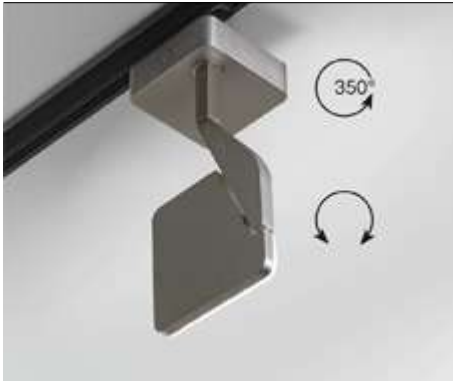

Faretto in pressofusione di alluminio per binario elettrificato. Diffusore in policarbonato con perimetro luminescente e doppia serigrafia studiata per ottimizzare il fascio luminoso e ridurre l'abbagliamento. Fascio luminoso orientabile generato da 1 modulo LED composto da 18 diodi. Struttura rifinita con vernice poliaccrilica in bianco, nero o spazzolato e verniciato colore titanio. Testa rotante su 2 assi grazie a un doppio snodo anche per luce indiretta.

Spotlight in die-cast aluminium for electrified track. Diffuser in polycarbonate with luminous perimeter and double screen serigraphy, designed to optimize the beam and reduce the glaring. Swivelling light beam created by 1 LED module consisting of 18 diodes. Structure finished with polyacrylic paint in white, black or brushed and finished titanium. Rotating head on 2-axis through a double joint able to make also indirect light.

CODICE CODE	FONTI LUMINOSE LIGHT SOURCES	kg
B07701.000.0101	Potenza assorbita apparecchio / Luminaire power consumption 8,5W	0,66
B07702.000.0101	Flusso luminoso apparecchio / Luminaire luminous flux 820lm	
B07730.000.0101	3000K Ra>80 90° 220-240V AC ON-OFF	
	IP40	

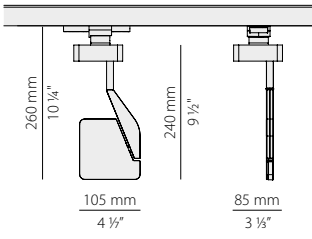

Fotometrie disponibili www.panzeri.it / Photometric data available at www.panzeri.it

CODICI COLORI DISPONIBILI / COLOUR CODES AVAILABLE

- 01** bianco / white
- 02** nero / black
- 30** titanio / titanium





QUEENS 45



Queens 45 è un proiettore dalle dimensioni compatte per binari elettrificati trifase, progettato per LED COB di ultima generazione. La disponibilità di differenti fasci luminosi e l'orientamento del corpo fino a 355° consentono molteplici soluzioni e regie luminose nel retail, spazi commerciali, musei ed aree espositive. Viene fornito completo di riflettore termoplastico metallizzato a specchio con ottica standard a fascio medio. Ottiche per fascio stretto o largo ordinabili su richiesta. Disponibile nella versione 3000K e nei colori bianco e nero.

Queens 45 is a compact projector for tri-phase electrified tracks, engineered with COB LEDs of latest generation. The availability of different light beams and the 355° adjustment of the light direction allows multiple solutions and scenarios in retail stores, commercial spaces, museums, exhibition halls. Supplied with metallized mirrored thermoplastic reflector with standard lens with medium beam. Reflectors for narrow or wide beam available upon request. Available in 3000K and in white or black finish.

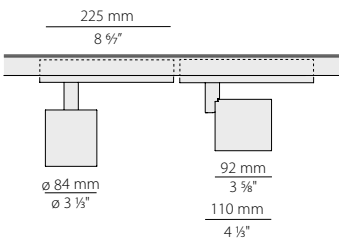

CODICE CODE	FONTI LUMINOSE LIGHT SOURCES	kg
B77001.037.4001	Potenza assorbita apparecchio / Luminaire power consumption 37W	0,90
B77002.037.4001	Flusso luminoso apparecchio / Luminaire luminous flux 4450lm 3000K Ra>85 30° 220-240V AC ON-OFF	
LED IP20 850°		

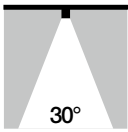

STANDARD

Ottica per fascio medio.
Flood optic.

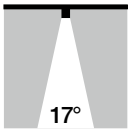

XMR1

Ottica per fascio stretto.
Spot optic.

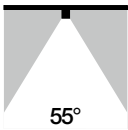

XMR3

Ottica per fascio largo.
Wide flood optic.

Fotometrie disponibili www.panzeri.it / Photometric data available at www.panzeri.it

CODICI COLORI DISPONIBILI / COLOUR CODES AVAILABLE

- 01** bianco / white
- 02** nero / black



QUEENS 25



Proiettore in pressofusione di alluminio a dissipazione termica passiva per binario elettrificato trifase, con LED ad alta efficienza e adattatore integrato. Può essere ruotato rispetto all'asse verticale fino a 355° e di 90° verso l'alto. Riflettore termoplastico metallizzato a specchio con ottica standard a fascio medio e ottiche per fascio stretto, largo o molto largo disponibili su richiesta. Disponibile nelle versioni 3000K e 4000K e nei colori bianco e nero.

Die-cast aluminium spotlight with passive thermal dissipation for three-phase electrified track, equipped with high efficiency LED and integrated adapter. It can rotate up to 355° with respect to the vertical axis and pivot up to 90° upwards. Mirror-metallized thermoplastic reflector with flood standard light beam and spot, wide flood or extra wide flood optics available on request. Available in 3000K and 4000K versions, in white and black colours.

CODICE CODE		FONTI LUMINOSE LIGHT SOURCES	kg
	XM751-30-01-3K XM751-30-02-3K	Potenza assorbita apparecchio / Luminaire power consumption 30W Flusso luminoso apparecchio / Luminaire luminous flux 2552lm 3000K Ra>85 29° 220-240V AC ON-OFF IP20 850°	1,04
	XM751-30-01-4K XM751-30-02-4K	Potenza assorbita apparecchio / Luminaire power consumption 30W Flusso luminoso apparecchio / Luminaire luminous flux 2617lm 4000K Ra>85 29° 220-240V AC ON-OFF IP20 850°	1,04
	STANDARD	Ottica per fascio medio. Flood optic.	
	XMR5	Ottica per fascio stretto Spot optic	0,01
	XMR7	Ottica per fascio largo Wide flood optic	0,01
	XMR8	Ottica per fascio largo Wide flood optic	0,01
Fotometrie disponibili www.panzeri.it / Photometric data available at www.panzeri.it UGR < 16 in funzione delle condizioni di installazione / UGR < 16 depending on installation conditions			
CODICI COLORI DISPONIBILI / COLOUR CODES AVAILABLE			
01 bianco white	02 nero black		



QUEENS 20



Queens 20 è un proiettore dalle dimensioni compatte per binari elettrificati trifase, progettato per LED COB di ultima generazione. La disponibilità di differenti fasci luminosi consente molteplici soluzioni e regie luminose nel retail, spazi commerciali, musei ed aree espositive. Viene fornito completo di riflettore termoplastico metallizzato a specchio con ottica standard a fascio medio. Ottiche per fascio stretto o largo ordinabili su richiesta. Disponibile nella versione 3000K e nei colori bianco e nero.

Queens 20 is a compact projector for tri-phase electrified tracks, engineered with COB LEDs of latest generation. The availability of different light beams allows multiple solutions and scenarios in retail stores, commercial spaces, museums, exhibition halls. Supplied with metallized mirrored thermoplastic reflector with standard lens with a medium beam. Reflectors for narrow or wide beam available upon request. Available in 3000K and in white or black finish.

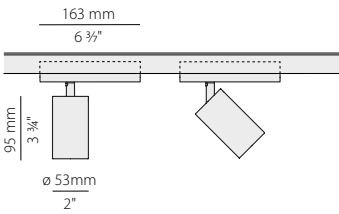

CODICE CODE	FONTI LUMINOSE LIGHT SOURCES	kg
B76001.026.2501	Potenza assorbita apparecchio / Luminaire power consumption 26W	0,40
B76002.026.2501	Flusso luminoso apparecchio / Luminaire luminous flux 1890lm 3000K Ra>90 30° 220-240V AC ON-OFF	
LED IP20 850°		

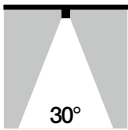

STANDARD

Ottica per fascio medio.
Flood optic.

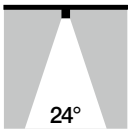

XMR5

Ottica per fascio stretto
Spot optic

0,01

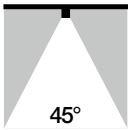

XMR7

Ottica per fascio largo
Wide flood optic

0,01

Fotometrie disponibili www.panzeri.it / Photometric data available at www.panzeri.it

CODICI COLORI DISPONIBILI / COLOUR CODES AVAILABLE

01 bianco
white

02 nero
black





QUEENS 10



Proiettore in pressofusione di alluminio a dissipazione termica passiva con adattatore per binario elettrificato trifase, equipaggiato con LED ad alta efficienza. Può essere ruotato rispetto all'asse verticale di 355° e di 90° verso l'alto. Cilindro antiabbagliamento di serie. Riflettore termoplastico metallizzato a specchio con ottica standard a fascio medio e ottiche per fascio stretto o largo disponibili su richiesta. Disponibile nella versione 3000K e nei colori bianco e nero.

Die-cast aluminium spotlight with passive thermal dissipation with adapter for threephase electrified track, equipped with high efficiency LED. It can rotate up to 355° with respect to the vertical axis and pivot up to 90° upwards. Standard anti-glare snoot. Mirror-metallized thermoplastic reflector with flood standard light beam and spot or wide flood optics available on request. Available in 3000K version, in white and black colours.

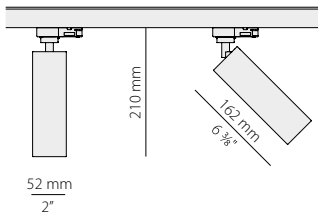

CODICE CODE	FONTI LUMINOSE LIGHT SOURCES	kg
XM748-12-01-3K	Potenza assorbita apparecchio / Luminaire power consumption 12W	0,50
XM748-12-02-3K	Flusso luminoso apparecchio / Luminaire luminous flux 1221lm 3000K Ra>90 30° 220-240V AC ON-OFF	
	IP20 850°	

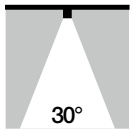

STANDARD Ottica per fascio medio.
Flood optic.

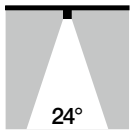

XMR5 Ottica per fascio stretto
Spot optic 0,01

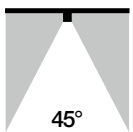

XMR7 Ottica per fascio largo
Wide flood optic 0,01

Fotometrie disponibili www.panzeri.it / Photometric data available at www.panzeri.it UGR < 11 in funzione delle condizioni di installazione / UGR < 11 depending on installation conditions

CODICI COLORI DISPONIBILI / COLOUR CODES AVAILABLE

01 bianco white **02** nero black



QUEENS



Sistema di binari trifase a tre accensioni (tensione di rete 230/250V, tensione di rete industriale 380/440V, carico complessivo 16A) disponibile in tre differenti lunghezze per applicazioni a plafone e a sospensione. Il sistema è costruito in lega di alluminio estruso con cavi conduttori in rame alloggiati all'interno di profilati estrusi in PVC ad alta resistenza di isolamento. Il sistema è a sezione quadra in colore bianco o nero e comprende un'ampia varietà di accessori e giunti di collegamento che lo rendono ideale nella progettazione illuminotecnica per flessibilità e versatilità.

System of three-phase tracks with three circuits (power supply 230/250V, industrial power supply 380/440V, total load 16A) available in three different lengths for installation at the ceiling or suspended. The system is made of extruded aluminium alloy with copper wires located inside the extruded PVC profiles with high insulating properties. The system is square-shaped in colour white or black and includes a wide range of accessories and joints that makes it extremely flexible and versatile in lighting design.

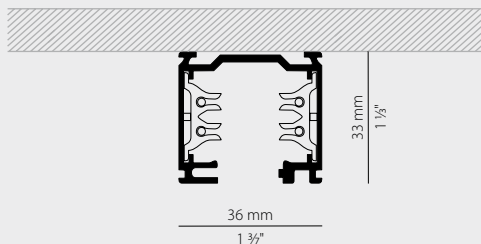

THREE-PHASE ELECTRIFIED TRACK

IP20 850°

CODICE / CODE	L MM	L INCHES	kg
XM7501-100	1000	39 3/8"	0,80
XM7502-100	1000	39 3/8"	0,80
XM7501-200	2000	78 7/8"	1,60
XM7502-200	2000	78 7/8"	1,60
XM7501-300	3000	118 1/8"	2,40
XM7502-300	3000	118 1/8"	2,40

CODICI COLORI DISPONIBILI / COLOUR CODES AVAILABLE

01 bianco
white

02 nero
black

ACCESSORI / ACCESSORIES

XM7501

XM7502

Adattatore elettromeccanico 6A, portata 5kg, per binario elettrificato trifase.
Electro/mechanical adapter 6A, mechanical load 5kg, for three-phase electrified track.

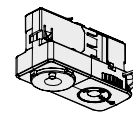

kg

0,05

XM76ADX01

XM76ADX02

Alimentazione destra per binario elettrificato trifase.
Right live-end for three-phase electrified track.

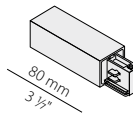

0,09

XM76ASX01

XM76ASX02

Alimentazione sinistra per binario elettrificato trifase.
Left live-end for three-phase electrified track.

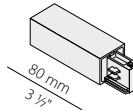

0,09



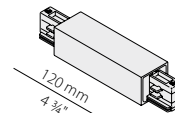

XM76A01

XM76A02

Alimentazione centrale e giunzione lineare per binario elettrificato trifase.
Central connector and straight joint for three-phase electrified track.

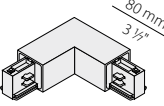
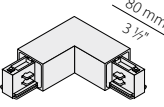
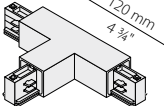
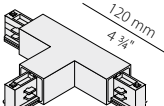
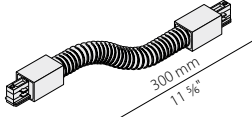

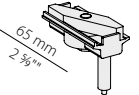
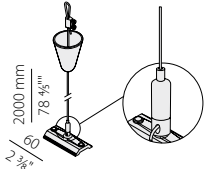
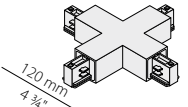
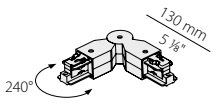
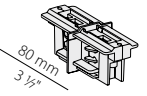
0,17

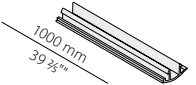
XM76LI01 XM76LI02 Giunzione a "L" interna per binario elettrificato trifase. Internal "L" joint for three-phase electrified track.		0,17
XM76LE01 XM76LE02 Giunzione a "L" esterna per binario elettrificato trifase. External "L" joint for three-phase electrified track.		0,17
XM76TDX01 XM76TDX02 Giunzione a "T" destra per binario elettrificato trifase. Right "T" joint for three-phase electrified track.		0,20
XM76TSX01 XM76TSX02 Giunzione a "T" sinistra per binario elettrificato trifase. Left "T" joint for three-phase electrified track.		0,20
XM76F01 XM76F02 Giunzione flessibile per binario elettrificato trifase. Flexible joint for three-phase electrified track.		0,25
XM76U01 XM76U02 Giunzione lineare senza contatti per binario elettrificato trifase. Mechanical straight joint for three-phase electrified track.		0,04
XM76B01 XM76B02 Adattatore meccanico con bloccacavo automatico per binario elettrificato trifase. Mechanical adapter with automatic locking for three-phase electrified track.		0,10
XM76S01 XM76S02 Kit di sospensione con fune in acciaio di lunghezza 2m (78,7") e piattina per binario elettrificato trifase. Suspension kit with 2m (78,7") long steel wire and plate for three-phase electrified track.		0,05
XM76X01 XM76X02 Giunzione a "X" per binario elettrificato trifase. "X" joint for three-phase electrified track.		0,30
XM76M01 XM76M02 Giunzione mobile per binario elettrificato trifase. Mobile joint for three-phase electrified track.		0,17
XM76Q01 XM76Q02 Giunzione lineare con contatti e con blocco per binario elettrificato trifase. Electrical straight joint with stop for three-phase electrified track.		0,05
XM76K Kit per attacco a soffitto per binario elettrificato trifase. Ceiling kit for three-phase electrified track.		0,02
XM76E01 XM76E02 Testata di chiusura per binario elettrificato trifase. End cap for three-phase electrified track.		0,01
XM76C01 XM76C02 Copertura di lunghezza 1000mm (39,4") per binario elettrificato trifase. Cover 1000mm (39,4") long for three-phase electrified track.		0,06



SOHO 20



Proiettore in pressofusione di alluminio con LED ad alta efficienza e adattatore integrato per binario elettrificato a bassa tensione 48V. Cilindro antiabbagliamento e vetro zigrinato di serie. Riflettore termoplastico metallizzato a specchio con ottica standard a fascio medio e ottiche per fascio stretto o largo disponibili su richiesta. Disponibile nella versione 3000K e nei colori bianco e nero.

Die-cast aluminium spotlight with high efficiency LED and integrated adapter for 48V low voltage electrified track. Standard anti-glare snoot and prismatic spread lens. Mirror-metallized thermoplastic reflector with flood standard light beam and spot or wide flood optics available on request. Available in 3000K version, in white and black colours.

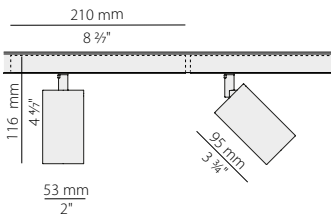

CODICE CODE	FONTI LUMINOSE LIGHT SOURCES	kg
B75401.026.2516	Potenza assorbita apparecchio / Luminaire power consumption 26W	0,40
B75402.026.2516	Flusso luminoso apparecchio / Luminaire luminous flux 1890lm 3000K Ra>90 30° 48V DC ON-OFF	
	IP20 850°	

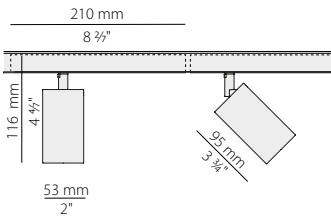

B75401.026.2519	Potenza assorbita apparecchio / Luminaire power consumption 26W	0,40
B75402.026.2519	Flusso luminoso apparecchio / Luminaire luminous flux 1890lm 3000K Ra>90 30° 48V DC dimmable (DALI)	
	IP20 850°	

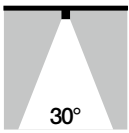

STANDARD	Ottica per fascio medio. Flood optic.	
-----------------	--	--

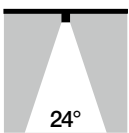

XMR5	Ottica per fascio stretto Spot optic	0,01
-------------	---	------

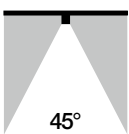

XMR7	Ottica per fascio largo Wide flood optic	0,01
-------------	---	------



XMR12	Cilindro interno colore oro satinato Internal satin gold cylinder	0,02
--------------	--	------

Fotometrie disponibili www.panzeri.it / Photometric data available at www.panzeri.it UGR < 16 in funzione delle condizioni di installazione / UGR < 16 depending on installation conditions

CODICI COLORI DISPONIBILI / COLOUR CODES AVAILABLE

- 01** bianco / white
- 02** nero / black



SOHO 10



Proiettore in pressofusione di alluminio con LED ad alta efficienza e adattatore integrato per binario elettrificato a bassa tensione 48V. Cilindro antiabbagliamento e vetro zigrinato di serie. Riflettore termoplastico metallizzato a specchio con ottica standard a fascio medio e ottiche per fascio stretto o largo disponibili su richiesta. Disponibile nella versione 3000K e nei colori bianco e nero.

Die-cast aluminium spotlight with high efficiency LED and integrated adapter for 48V low voltage electrified track. Standard anti-glare snoot and prismatic spread lens. Mirror-metallized thermoplastic reflector with flood standard light beam and spot or wide flood optics available on request. Available in 3000K version, in white and black colours.

	CODICE CODE	FONTI LUMINOSE LIGHT SOURCES	kg
	B75301.018.2516 B75302.018.2516	Potenza assorbita apparecchio / Luminaire power consumption 18W Flusso luminoso apparecchio / Luminaire luminous flux 1436lm 3000K Ra>90 30° 48V DC ON-OFF IP20 850°	0,40
	B75301.018.2519 B75302.018.2519	Potenza assorbita apparecchio / Luminaire power consumption 18W Flusso luminoso apparecchio / Luminaire luminous flux 1436lm 3000K Ra>90 30° 48V DC dimmable (DALI) IP20 850°	0,40
	STANDARD	Ottica per fascio medio. Flood optic.	
	XMR10	Ottica per fascio stretto Spot optic	0,04
	XMR11	Ottica per fascio largo Wide flood optic	0,04
	XMR12	Cilindro interno colore oro satinato Internal satin gold cylinder	0,02

Fotometrie disponibili www.panzeri.it / Photometric data available at www.panzeri.it

UGR < 16 in funzione delle condizioni di installazione / UGR < 16 depending on installation conditions

CODICI COLORI DISPONIBILI / COLOUR CODES AVAILABLE

- 01** bianco / white
02 nero / black



SOHO 5



Proiettore in pressofusione di alluminio con LED ad alta efficienza e adattatore integrato per binario elettrificato a bassa tensione 48V. Completo di cilindro antiabbagliamento e lente per fascio stretto in materiale termoplastico. Disponibile nella versione 3000K e nei colori bianco e nero.

Die-cast aluminium spotlight with high efficiency LED and integrated adapter for 48V low voltage electrified track. Complete with standard anti-glare snoot and thermoplastic lens for narrow beam. Available in 3000K version, in white and black colours.

NOVELTY

CODICE CODE

FONTI LUMINOSE LIGHT SOURCES

kg

B75201.008.2416

Potenza assorbita apparecchio / Luminaire power consumption 7,3W

0,30

B75202.008.2416

Flusso luminoso apparecchio / Luminaire luminous flux 613lm
3000K Ra>90 14° 48V DC ON-OFF

IP20 850°

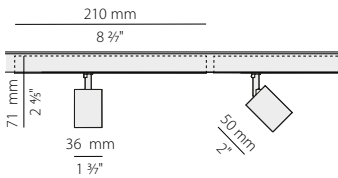

B75201.008.2419

Potenza assorbita apparecchio / Luminaire power consumption 7,3W

0,30

B75202.008.2419

Flusso luminoso apparecchio / Luminaire luminous flux 613lm
3000K Ra>90 14° 48V DC dimmable (DALI)

IP20 850°

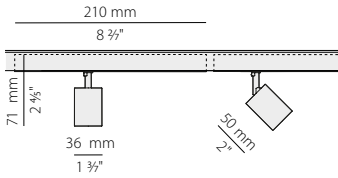

Fotometrie disponibili www.panzeri.it / Photometric data available at www.panzeri.it

CODICI COLORI DISPONIBILI / COLOUR CODES AVAILABLE

01 bianco
white

02 nero
black





SOHO S 15





Elegante proiettore a sospensione per installazioni su binari elettrificati 48V DC. L'apparecchio è equipaggiato con LED COB ad alta efficienza e può essere personalizzato con diversi accessori per un miglior comfort visivo. Le ottiche arretrate e lo snoot di serie riducono al minimo l'abbagliamento. Viene fornito completo di riflettore termoplastico metallizzato a specchio con ottica standard a fascio medio. Ottiche per fascio stretto o largo ordinabili su richiesta. Il suo design, dalle linee compatte e dalla sottile testa cilindrica, si inserisce facilmente in numerosi contesti, dal retail, all'hospitality, al residenziale. Disponibile nella versione 3000K e nei colori bianco e nero.

Elegant suspended projector for installation on 48V DC electrified tracks. The fitting is equipped with high-efficiency COB LED and it can be customized with various accessories for an improved visual comfort. The recessed lens and the snoot minimize the glare. Supplied with metallized mirrored thermoplastic reflector with standard lens with medium beam. Reflectors for narrow or wide beam available upon request. The minimal and compact design of the cylindrical head suits a variety of project applications in retail stores, hospitality, residential spaces. Available in 3000K in the finishes white or black.

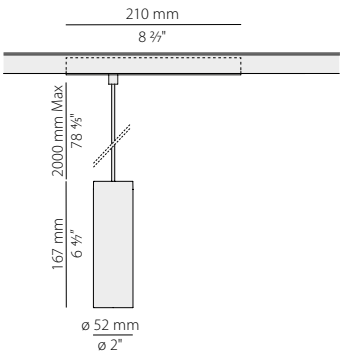
CODICE CODE	FONTI LUMINOSE LIGHT SOURCES	kg
-------------	------------------------------	----



 **B70001.018.2516**
B70002.018.2516

Potenza assorbita apparecchio / Luminaire power consumption 18W	0,50
Flusso luminoso apparecchio / Luminaire luminous flux 1705lm	
3000K Ra>90 30° 48V DC ON-OFF	
 IP20 850° 	

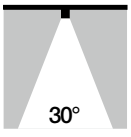
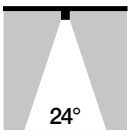
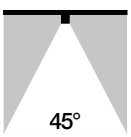
	STANDARD	Ottica per fascio medio. Flood optic.	
	XMR5	Ottica per fascio stretto Spot optic	0,01
	XMR7	Ottica per fascio largo Wide flood optic	0,01

Fotometrie disponibili www.panzeri.it / Photometric data available at www.panzeri.it UGR < 11 in funzione delle condizioni di installazione / UGR < 11 depending on installation conditions

CODICI COLORI DISPONIBILI / COLOUR CODES AVAILABLE

01 bianco
white

02 nero
black



SOHO LINE



Modulo lineare a luce diffusa per binari elettrificati a bassa tensione 48V per applicazioni soffitto/parete, sospensione e incasso, con schermo in policarbonato opale. Trasformatore elettronico remoto per binario 48V da ordinare separatamente. Disponibile in colore bianco o nero. Non compatibile con sistema DALI.

Linear diffused LED module with opal polycarbonate screen for 48V low voltage electrified tracks for ceiling/wall, suspension and recessed applications. Electronic transformer for remote use for 48V track to order separately. White and black finishes are available. Not compatible with DALI system.

CODICE CODE	FONTI LUMINOSE LIGHT SOURCES	kg
-------------	------------------------------	----

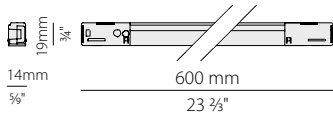

B47001.060.0416
B47002.060.0416

Potenza assorbita apparecchio / Luminaire power consumption 12W
Flusso luminoso apparecchio / Luminaire luminous flux 740lm
3000K Ra>90 48V DC ON-OFF

0,30

IP20

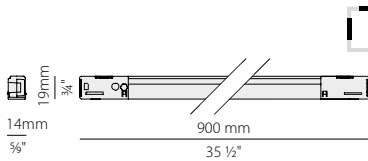

B47001.090.0416
B47002.090.0416

Potenza assorbita apparecchio / Luminaire power consumption 19W
Flusso luminoso apparecchio / Luminaire luminous flux 1244lm
3000K Ra>90 48V DC ON-OFF

0,30

IP20

Fotometrie disponibili www.panzeri.it / Photometric data available at www.panzeri.it

CODICI COLORI DISPONIBILI / COLOUR CODES AVAILABLE

01 bianco
white

02 nero
black

SOHO IN



Sistema di binari a bassa tensione 48V, disponibile in tre differenti lunghezze per applicazioni ad incasso. Il sistema è costruito in lega di alluminio estruso verniciato poliesteri, predisposto per alloggiare i proiettori provvisti di adattatore 48V. Possibilità di regolazione DALI. Il sistema è a sezione quadra, in colore nero. Disponibile un'ampia varietà di accessori e giunti di collegamento.

System of 48V electrified tracks, available in three different lengths for recessed use. The system is made of extruded aluminium alloy with polyester coating, suitable to host spotlights equipped with 48V adapter. Possibility of DALI dimming. The system is square-shaped, in black colour. Wide range of available accessories and joints.

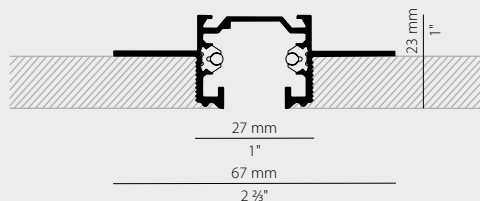

TRIMLESS RECESSED ELECTRIFIED TRACK 48V DC

IP20 850°

CODICE / CODE	L MM	L INCHES	kg
XM44602-100	1000	39 3/8"	0,73
XM44602-200	2000	78 7/8"	1,45
XM44602-300	3000	118 1/2"	2,18

CODICI COLORI DISPONIBILI / COLOUR CODES AVAILABLE

02 nero
black

ACCESSORI / ACCESSORIES

XM44501-C

XM44502-C

Copertura di lunghezza 1000mm (39,4") per binario elettrificato 48V DC.
Cover 1000mm (39,4") long for 48V DC electrified track.

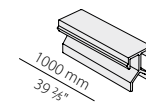

kg
0,10

XM44602-ADX

Alimentazione destra per binario elettrificato 48V DC da incasso.
Right live-end for 48V DC recessed electrified track.

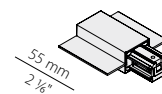

0,04

XM44602-ASX

Alimentazione sinistra per binario elettrificato 48V DC da incasso.
Left live-end for 48V DC recessed electrified track.

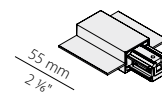

0,04

XM44602-A

Alimentazione centrale per binario elettrificato 48V DC da incasso.
Central connector for 48V DC recessed electrified track.

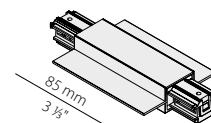

0,07

XM44502-UE

Giunto lineare per binario elettrificato 48V DC.
Straight joint for 48V DC electrified track.

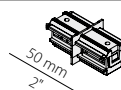

0,02

XM44502-UM

Giunto lineare senza contatti per binario elettrificato 48V DC.
Mechanical straight joint for 48V DC electrified track.

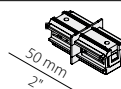

0,01

ACCESSORI / ACCESSORIES

kg

YDV.048.150.A02

Trasformatore elettronico DALI, 150W 48V DC, per binario elettrificato 48V DC.
DALI electronic transformer, 150W 48V DC, for 48V DC electrified track.

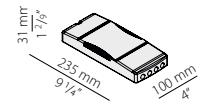

0,40

NOVELTY**YDV.048.075.A01**

Trasformatore elettronico, 75W 48V DC, per binario elettrificato 48V DC.
Electronic transformer, 75W 48V DC, for 48V DC electrified track.

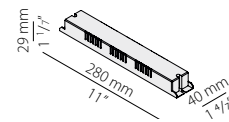

0,38

NOVELTY**YDV.048.150.A01**

Trasformatore elettronico, 150W 48V DC, per binario elettrificato 48V DC.
Electronic transformer, 150W 48V DC, for 48V DC electrified track.

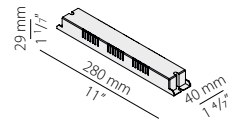

0,38

NOVELTY**XM44602-E**

Testata di chiusura per binario elettrificato 48V DC da incasso.
End cap for 48V DC recessed electrified track.

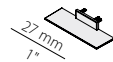

0,07

XM446-P

Piattina per fissaggio a plafone binario elettrificato 48V DC da incasso.

ACCESSORIO OBBLIGATORIO DA POSIZIONARE OGNI METRO CIRCA.

Plate for fixing ceiling pendants for 48V DC recessed electrified track.

MANDATORY ACCESSORY TO BE POSITIONED EVERY METER APPROX.

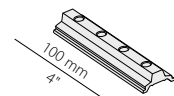

0,05

SOHO OUT

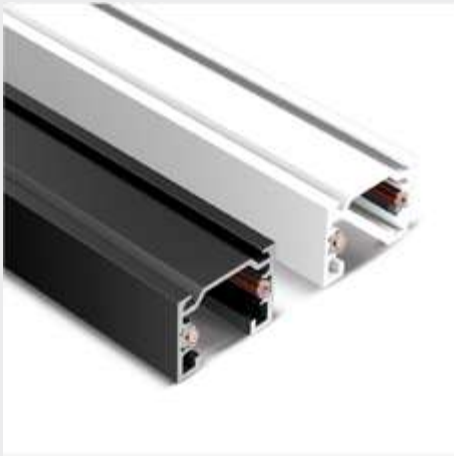

Sistema di binari a bassa tensione 48V, disponibile in tre differenti lunghezze per applicazioni a soffitto/parete e a sospensione. Il sistema è costruito in lega di alluminio estruso verniciato poliestere, predisposto per alloggiare i proiettori provvisti di adattatore 48V. Possibilità di regolazione DALI. Il sistema è a sezione quadra, in colore bianco e nero. Disponibile un'ampia varietà di accessori e giunti di collegamento.

System of 48V electrified tracks, available in three different lengths for ceiling/wall or suspended use. The system is made of extruded aluminium alloy with polyester coating, suitable to host spotlights equipped with 48V adapter. Possibility of DALI dimming. The system is square-shaped, in white or black colour. Wide range of available accessories and joints.

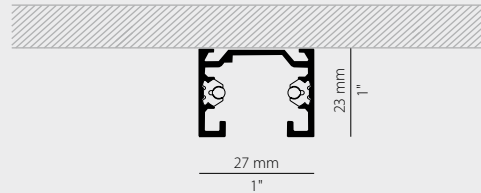

ELECTRIFIED TRACK 48V DC

IP20 850°

CODICE / CODE	L MM	L INCHES	kg
XM44501-100	1000	39 2/5"	0,50
XM44502-100	1000	39 2/5"	0,50
XM44501-200	2000	78 4/5"	1,00
XM44502-200	2000	78 4/5"	1,00
XM44501-300	3000	118 1/5"	1,70
XM44502-300	3000	118 1/5"	1,70

CODICI COLORI DISPONIBILI / COLOUR CODES AVAILABLE

01 bianco
white

02 nero
black

ACCESSORI / ACCESSORIES

XM44501-C

XM44502-C

Copertura di lunghezza 1000mm (39,4") per binario elettrificato 48V DC.
Cover 1000mm (39,4") long for 48V DC electrified track.

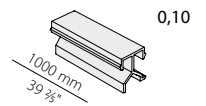

kg

0,10

XM44501-ADX

XM44502-ADX

Alimentazione destra per binario elettrificato 48V DC a sospensione o a soffitto.
Right live-end for 48V DC suspended or ceiling electrified track.

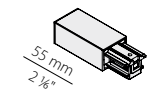

0,04

XM44501-ASX

XM44502-ASX

Alimentazione sinistra per binario elettrificato 48V DC a sospensione o a soffitto.
Left live-end for 48V DC suspended or ceiling electrified track.

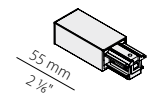

0,04

XM44501-A

XM44502-A

Alimentazione centrale per binario elettrificato 48V DC a sospensione o a soffitto.
Central connector for 48V DC suspended or ceiling electrified track.

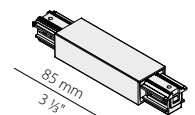

0,06



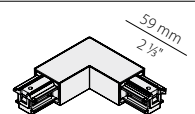

XM44501-LI

XM44502-LI

Giunzione a "L" interna per binario elettrificato 48V DC a sospensione o a soffitto.
Internal "L" joint for 48V DC suspended or ceiling electrified track.

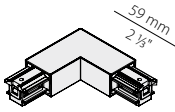
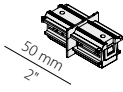
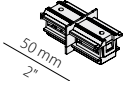
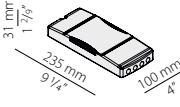
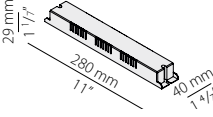
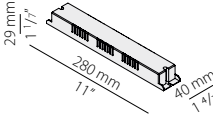

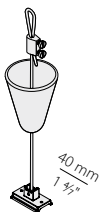
0,06

	kg
XM44501-LE XM44502-LE Giunzione a "L" esterna per binario elettrificato 48V DC a sospensione o a soffitto. External "L" joint for 48V DC suspended or ceiling electrified track.	 0,06
XM44501-UE XM44502-UE Giunto lineare per binario elettrificato 48V DC. Straight joint for 48V DC electrified track.	 0,02
XM44501-UM XM44502-UM Giunto lineare senza contatti per binario elettrificato 48V DC. Mechanical straight joint for 48V DC electrified track.	 0,01
YDV.048.150.A02 Trasformatore elettronico DALI, 150W 48V DC, per binario elettrificato 48V DC. DALI electronic transformer, 150W 48V DC, for 48V DC electrified track.	 0,40
NOVELTY	
YDV.048.075.A01 Trasformatore elettronico, 75W 48V DC, per binario elettrificato 48V DC. Electronic transformer, 75W 48V DC, for 48V DC electrified track.	 0,38
NOVELTY	
YDV.048.150.A01 Trasformatore elettronico, 150W 48V DC, per binario elettrificato 48V DC. Electronic transformer, 150W 48V DC, for 48V DC electrified track.	 0,38
NOVELTY	
XM44501-E XM44502-E Testata di chiusura per binario elettrificato 48V DC a sospensione o a soffitto. End cap for 48V DC suspended or ceiling electrified track.	 0,10
XM44501-S XM44502-S Kit di sospensione con fune in acciaio di lunghezza 2m (78,7") e piattina per binario elettrificato 48V DC. Suspension kit with 2m (78,7") long steel wire and plate for 48V DC electrified track.	 0,03
XM44501-K XM44502-K Kit per attacco a soffitto per binario elettrificato 48V DC. Ceiling kit for 48V DC electrified track.	 0,03

INCASSI / RECESSED

262	CLICK CLACK
264	EAST
271	EDDIE
274	JAMES
278	JARVIS
280	JESSIE
296	JOE
282	MARK
269	MOAI
286	NICK
288	RALLY TRIM
297	ROY
292	SID
267	STEP BY STEP
294	TAYLOR



CLICK CLACK

Enzo Panzeri 2019

Click clack è un incasso in gesso con un foro di 35mm. Garantisce massima praticità grazie ad uno speciale meccanismo "push&pull" che consente il ribassamento del portalamпада per la sostituzione della sorgente luminosa, evitando invasivi interventi di manutenzione.

Click clack is a plaster recessed fitting with a 35mm hole. It guarantees maximum functionality thanks to a special push&pull mechanism that allows the lamp holder to be lowered to replace the light source, avoiding invasive maintenance operations.



kg

0,45

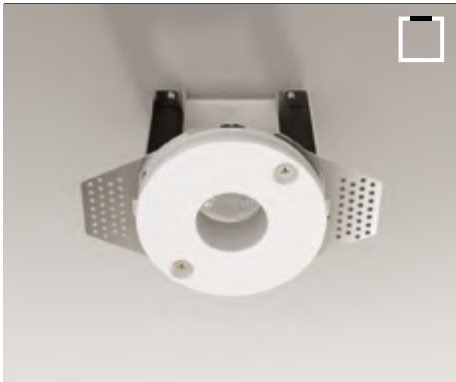

XGR1212
XM3 lampholder with terminal block
LED retrofit bulb 4W GU10 Ø 35mm 3000K Ra80 330lm (no dimming)

IP20

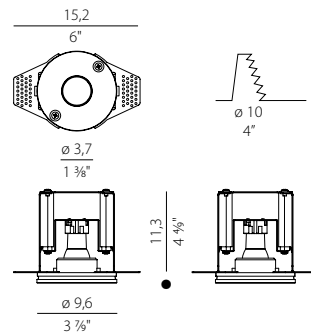

+ Electric options
(see details on page 300)

XM5/GU10-35 retrofit lamp

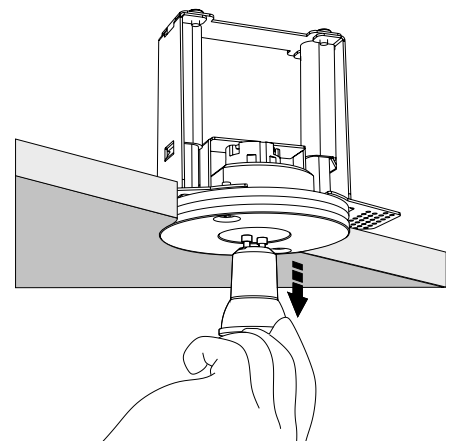
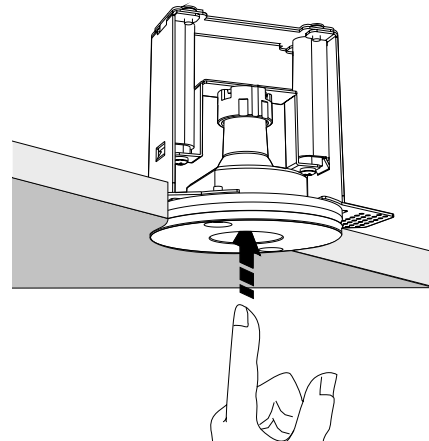

- Minima altezza di ingombro dell'apparecchio (le quote minime del vano di incasso sono riportate sul foglio di istruzioni)

Minimum height of the appliance (see the minimum values for housing compartment in the instruction sheets)

Lampadina non inclusa, vedi electric options.
Da acquistare separatamente.

Bulb not included, see electric options.
Please purchase separately.

Fotometrie disponibili www.panzeri.it / Photometric data available at www.panzeri.it

CODICI COLORI DISPONIBILI / COLOUR CODES AVAILABLE

42 gesso
plaster





EAST



Incassi in gesso fissi o orientabili. I prodotti sono venduti con alimentazione di serie GU10. Le elettrificazioni opzionali e i relativi driver sono forniti separatamente al prodotto e vanno eventualmente sostituiti a quelli di serie.

Fixed or adjustable plaster recessed luminaires. The products are sold with GU10 fittings. Different types of electricity supply and the related drivers substitute the series fitting.



XGR0997

XM3 lampholder with terminal block max 50W GU10

IP20

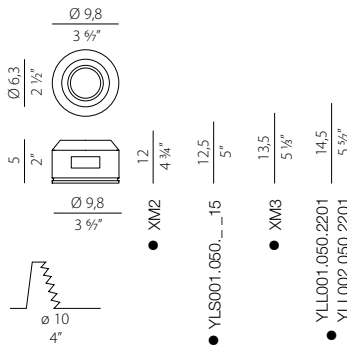

+ Electric options

(see details on page 300)

LAMP

- YLL001.050.2201 retrofit lamp
- YLL002.050.2201 retrofit lamp
- YLS001.050._._15 spot LED
- XM2 lampholder with terminal block

DRIVER

- XM6-15 UNI
- XM6-20 UNI *
- XM6-20 D/P MULTI *
- XM6-25 D/P MULTI

kg

0,24



XGQ0998

XM3 lampholder with terminal block max 50W GU10

IP20

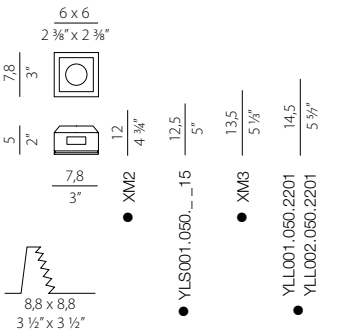

+ Electric options

(see details on page 300)

LAMP

- YLL001.050.2201 retrofit lamp
- YLL002.050.2201 retrofit lamp
- YLS001.050._._15 spot LED
- XM2 lampholder with terminal block

DRIVER

- XM6-15 UNI
- XM6-20 UNI *
- XM6-20 D/P MULTI *
- XM6-25 D/P MULTI

0,17

XM0998 85x85x155mm

Cassaforma per incasso in muratura in lamiera zincata.

Gruppo di alimentazione da prevedere remoto esternamente alla cassaforma.

Galvanized sheet housing to be recessed in brick wall or concrete.

Electrical power supply must be remote outside of the housing.

0,45

I prodotti sono venduti con cablaggio di serie GU10. Le elettrificazioni opzionali sono fornite separatamente al prodotto e vanno perciò sostituite a quelle di serie.

The products are sold with GU10 fittings. Different types of electric options are supplied separately and substitute the series fitting.

- Minima altezza di ingombro dell'apparecchio (le quote minime del vano di incasso sono riportate sul foglio di istruzioni) Minimum height of the appliance (see the minimum values for housing compartment in the instruction sheets)
- ★ Dimensione dell'alimentatore maggiore del foro d'incasso, dunque installare l'alimentatore in apposito vano d'ispezione. Power supply unit is larger than the recess hole, install the power supply unit in a special inspection compartment.

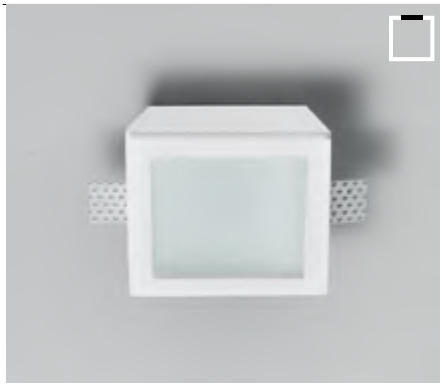
**XGQ0998-GL**

XM3 lampholder with terminal block max 50W GU10

IP20

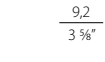
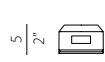
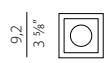
$$\frac{6 \times 6}{2 \frac{3}{8}'' \times 2 \frac{3}{8}''}$$

$$\frac{9,2}{3 \frac{3}{8}''}$$

$$\frac{5}{2''}$$

$$\frac{9,2}{3 \frac{3}{8}''}$$

$$\frac{12}{4 \frac{3}{4}''}$$

$$\frac{12,5}{5''}$$

$$\frac{13,5}{5 \frac{1}{8}''}$$

$$\frac{14,5}{5 \frac{9}{16}''}$$

$$\frac{10,2 \times 10,2}{4'' \times 4''}$$

● XM2

● YLS001.050._15

● XM3

● YLL001.050.2201

● YLL002.050.2201

+ Electric options

(see details on page 300)

LAMP

YLL001.050.2201 retrofit lamp

YLL002.050.2201 retrofit lamp

YLS001.050._15 spot LED

XM2 lampholder with terminal block

DRIVER

XM6-15 UNI

XM6-20 UNI ★

XM6-20 D/P MULTI ★

XM6-25 D/P MULTI

0,33

XM0998-GL 95x95x155mm

Cassaforma per incasso in muratura in lamiera zincata.

Gruppo di alimentazione da prevedere remoto esternamente alla cassaforma.

Galvanized sheet housing to be recessed in brick wall or concrete.

Electrical power supply must be remote outside of the housing.

0,52

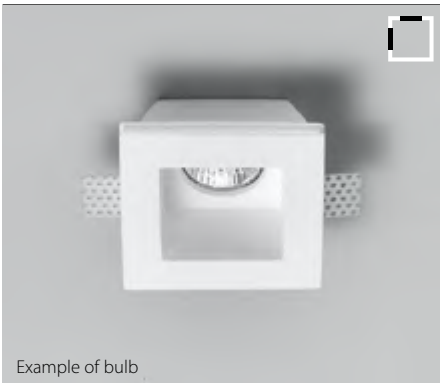

Example of bulb

XGQ1004

XM3 lampholder with terminal block max 50W GU10

IP20

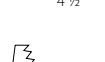
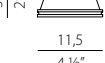
$$\frac{7 \times 7}{2 \frac{3}{4}'' \times 2 \frac{3}{4}''}$$

$$\frac{11,5}{4 \frac{1}{2}''}$$

$$\frac{5}{2''}$$

$$\frac{11,5}{4 \frac{1}{2}''}$$

$$\frac{11,5}{4 \frac{1}{2}''}$$

$$\frac{11,5}{4 \frac{1}{2}''}$$

$$\frac{11,5}{4 \frac{1}{2}''}$$

$$\frac{11,5}{4 \frac{1}{2}''}$$

$$\frac{12,5 \times 12,5}{5'' \times 5''}$$

● XM2

● YLS001.050._15

● XM3

● YLL001.050.2201

● YLL002.050.2201

+ Electric options

(see details on page 300)

LAMP

YLL001.050.2201 retrofit lamp

YLL002.050.2201 retrofit lamp

YLS001.050._15 spot LED

XM2 lampholder with terminal block

DRIVER

XM6-15 UNI

XM6-20 UNI ★

XM6-20 D/P MULTI ★

XM6-25 D/P MULTI

0,46

XGQ1004-GL

XM3 lampholder with terminal block max 50W GU10

IP20

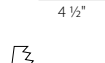
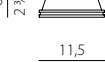
$$\frac{7 \times 7}{2 \frac{3}{4}'' \times 2 \frac{3}{4}''}$$

$$\frac{11,5}{4 \frac{1}{2}''}$$

$$\frac{6}{2 \frac{3}{8}''}$$

$$\frac{11,5}{4 \frac{1}{2}''}$$

$$\frac{11,5}{4 \frac{1}{2}''}$$

$$\frac{11,5}{4 \frac{1}{2}''}$$

$$\frac{11,5}{4 \frac{1}{2}''}$$

$$\frac{11,5}{4 \frac{1}{2}''}$$

$$\frac{12,5 \times 12,5}{5'' \times 5''}$$

● XM2

● YLS001.050._15

● XM3

● YLL001.050.2201

● YLL002.050.2201

+ Electric options

(see details on page 300)

LAMP

YLL001.050.2201 retrofit lamp

YLL002.050.2201 retrofit lamp

YLS001.050._15 spot LED

XM2 lampholder with terminal block

DRIVER

XM6-15 UNI

XM6-20 UNI ★

XM6-20 D/P MULTI ★

XM6-25 D/P MULTI

0,56

XM1004/1004-GL/1030 125x125x155mm

Cassaforma per incasso in muratura in lamiera zincata.

Gruppo di alimentazione da prevedere remoto esternamente alla cassaforma.

Galvanized sheet housing to be recessed in brick wall or concrete.

Electrical power supply must be remote outside of the housing.

0,71

I prodotti sono venduti con cablaggio di serie GU10.

Le elettrificazioni opzionali sono fornite separatamente al prodotto e vanno perciò sostituite a quelle di serie.

The products are sold with GU10 fittings.

Different types of electric options are supplied separately and substitute the series fitting.

- Minima altezza di ingombro dell'apparecchio (le quote minime del vano di incasso sono riportate sul foglio di istruzioni)

Minimum height of the appliance (see the minimum values for housing compartment in the instruction sheets)

- ★ Dimensione dell'alimentatore maggiore del foro d'incasso, dunque installare l'alimentatore in apposito vano d'ispezione.

Power supply unit is larger than the recess hole, install the power supply unit in a special inspection compartment.

REGISTERED DESIGN

XGR1021

XM3 lampholder with terminal block max 50W GU10

IP20

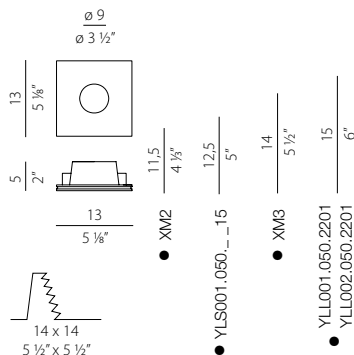

Example of bulb

+ Electric options

(see details on page 300)

LAMP

YLL001.050.2201 retrofit lamp
 YLL002.050.2201 retrofit lamp
 YLS001.050._15 spot LED
 XM2 lampholder with terminal block

DRIVER

XM6-15 UNI
 XM6-20 UNI ★
 XM6-20 D/P MULTI ★
 XM6-25 D/P MULTI

0,42

XM1021 140x140x155mm

Cassaforma per incasso in muratura in lamiera zincata.

Gruppo di alimentazione da prevedere remoto esternamente alla cassaforma.

Galvanized sheet housing to be recessed in brick wall or concrete.

Electrical power supply must be remote outside of the housing.

0,79

XGR1027

XM3 lampholder with terminal block max 50W GU10

IP20

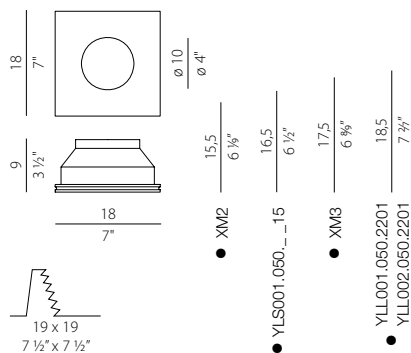

Example of bulb

+ Electric options

(see details on page 300)

LAMP

YLL001.050.2201 retrofit lamp
 YLL002.050.2201 retrofit lamp
 YLS001.050._15 spot LED
 XM2 lampholder with terminal block

DRIVER

XM6-15 UNI
 XM6-20 UNI
 XM6-20 D/P MULTI
 XM6-25 D/P MULTI

1,20

XM1027 185x185x190mm

Cassaforma per incasso in muratura in lamiera zincata.

Gruppo di alimentazione da prevedere remoto esternamente alla cassaforma.

Galvanized sheet housing to be recessed in brick wall or concrete.

Electrical power supply must be remote outside of the housing.

1,36

I prodotti sono venduti con cablaggio di serie GU10.

Le elettrificazioni opzionali sono fornite separatamente al prodotto e vanno perciò sostituite a quelle di serie.

The products are sold with GU10 fittings.

Different types of electric options are supplied separately and substitute the series fitting.

- Minima altezza di ingombro dell'apparecchio (le quote minime del vano di incasso sono riportate sul foglio di istruzioni) Minimum height of the appliance (see the minimum values for housing compartment in the instruction sheets)
- ★ Dimensione dell'alimentatore maggiore del foro d'incasso, dunque installare l'alimentatore in apposito vano d'ispezione. Power supply unit is larger than the recess hole, install the power supply unit in a special inspection compartment.



STEP BY STEP



Apparecchio wall washer in gesso con LED integrato di piccole dimensioni.

Small plaster wall washer with LED.



REGISTERED DESIGN

XGR1023

Potenza assorbita apparecchio / Luminaire power consumption 1W
Flusso luminoso apparecchio / Luminaire luminous flux 54lm
3000K Ra>80 350mA DC

LED IP20

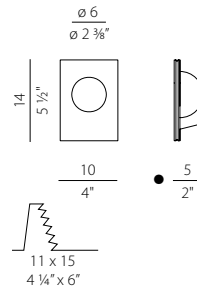

+ Electric options
(see details on page 300)

DRIVER
XM6-15 UNI ★
XM6-20 UNI ★
XM6-20 D/P MULTI ★
XM6-25 D/P MULTI ★

kg

0,40

XM1023/1026 149x108x60mm

Cassaforma per incasso in muratura in lamiera zincata.

Gruppo di alimentazione da prevedere remoto esternamente alla cassaforma.

Galvanized sheet housing to be recessed in brick wall or concrete.

Electrical power supply must be remote outside of the housing.

0,35

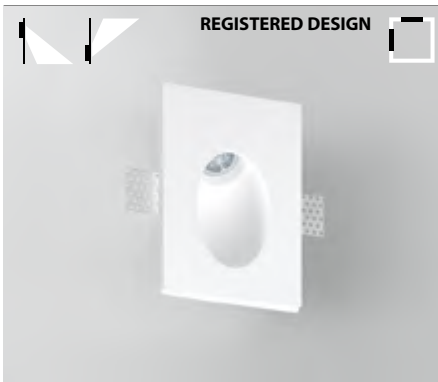

REGISTERED DESIGN

XGR1024

Potenza assorbita apparecchio / Luminaire power consumption 1W
Flusso luminoso apparecchio / Luminaire luminous flux 54lm
3000K Ra>80 350mA DC

LED IP20

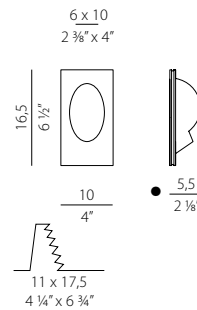

+ Electric options
(see details on page 300)

DRIVER
XM6-15 UNI ★
XM6-20 UNI ★
XM6-20 D/P MULTI ★
XM6-25 D/P MULTI ★

0,49

XM1024 173x108x60mm

Cassaforma per incasso in muratura in lamiera zincata.

Gruppo di alimentazione da prevedere remoto esternamente alla cassaforma.

Galvanized sheet housing to be recessed in brick wall or concrete.

Electrical power supply must be remote outside of the housing.

0,39

- Minima altezza di ingombro dell'apparecchio (le quote minime del vano di incasso sono riportate sul foglio di istruzioni)
- ★ Dimensione dell'alimentatore maggiore del foro d'incasso, dunque installare l'alimentatore in apposito vano d'ispezione.

Minimum height of the appliance (see the minimum values for housing compartment in the instruction sheets)

Power supply unit is larger than the recess hole, install the power supply unit in a special inspection compartment.



REGISTERED DESIGN

XGQ1025

Potenza assorbita apparecchio / Luminaire power consumption 1W
Flusso luminoso apparecchio / Luminaire luminous flux 54lm
3000K Ra>80 350mA DC

LED IP20

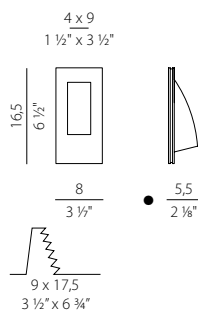

+ Electric options
(see details on page 300)

DRIVER
XM6-15 UNI ★
XM6-20 UNI ★
XM6-20 D/P MULTI ★
XM6-25 D/P MULTI ★

XM1025 171x90x60mm

Cassaforma per incasso in muratura in lamiera zincata.

Gruppo di alimentazione da prevedere remoto esternamente alla cassaforma.

Galvanized sheet housing to be recessed in brick wall or concrete.

Electrical power supply must be remote outside of the housing.

0,35



REGISTERED DESIGN

XGQ1026

Potenza assorbita apparecchio / Luminaire power consumption 1W
Flusso luminoso apparecchio / Luminaire luminous flux 54lm
3000K Ra>80 350mA DC

LED IP20

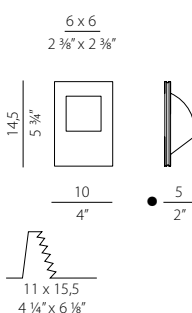

+ Electric options
(see details on page 300)

DRIVER
XM6-15 UNI ★
XM6-20 UNI ★
XM6-20 D/P MULTI ★
XM6-25 D/P MULTI ★

0,40

XM1023/1026 149x108x60mm

Cassaforma per incasso in muratura in lamiera zincata.

Gruppo di alimentazione da prevedere remoto esternamente alla cassaforma.

Galvanized sheet housing to be recessed in brick wall or concrete.

Electrical power supply must be remote outside of the housing.

0,35

- Minima altezza di ingombro dell'apparecchio (le quote minime del vano di incasso sono riportate sul foglio di istruzioni) Minimum height of the appliance (see the minimum values for housing compartment in the instruction sheets)
- ★ Dimensione dell'alimentatore maggiore del foro d'incasso, dunque installare l'alimentatore in apposito vano d'ispezione. Power supply unit is larger than the recess hole, install the power supply unit in a special inspection compartment.

Fotometrie disponibili www.panzeri.it / Photometric data available at www.panzeri.it

CODICI COLORI DISPONIBILI / COLOUR CODES AVAILABLE

42 gesso
plaster



MOAI



Wall washer in gesso con LED o alimentazione di serie GU10. Le elettrificazioni opzionali e i relativi driver sono forniti separatamente al prodotto e vanno eventualmente sostituiti a quelli di serie.

Plaster wall washer with LED or with GU10 fittings. Different types of electricity supply and the related drivers substitute the series fitting.



XGQ1210.0401

Potenza assorbita apparecchio / Luminaire power consumption 15W
Flusso luminoso apparecchio / Luminaire luminous flux 1063lm
3000K Ra>90 220-240V AC ON-OFF

XGQ1210.0402

Potenza assorbita apparecchio / Luminaire power consumption 15W
Flusso luminoso apparecchio / Luminaire luminous flux 1063lm
3000K Ra>90 220-240V AC dimmable (DALI/Push DIM)

IP20

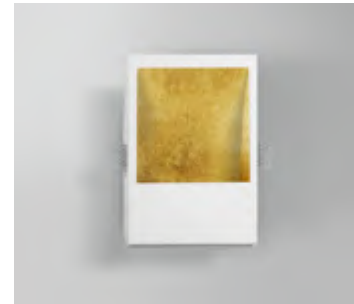
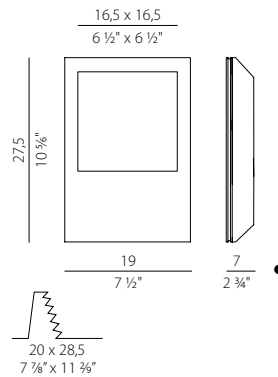

kg

2,01

2,01

XM1210 325x195x75mm

Cassaforma per incasso in muratura in lamiera zincata.
Galvanized sheet housing to be recessed in brick wall or concrete.

1,00

- Minima altezza di ingombro dell'apparecchio (le quote minime del vano di incasso sono riportate sul foglio di istruzioni)

Minimum height of the appliance (see the minimum values for housing compartment in the instruction sheets)

kg

**XGQ1211.0401**

Potenza assorbita apparecchio / Luminaire power consumption 15W
 Flusso luminoso apparecchio / Luminaire luminous flux 1063lm
 3000K Ra>90 220-240V AC ON-OFF

3,54

XGQ1211.0402

Potenza assorbita apparecchio / Luminaire power consumption 15W
 Flusso luminoso apparecchio / Luminaire luminous flux 1063lm
 3000K Ra>90 220-240V AC dimmable (DALI/Push DIM)

3,54

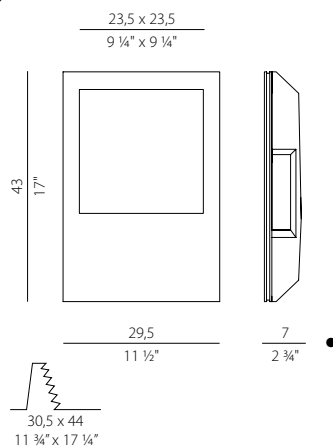
LED IP20**XM1211** 439x300x74mm

Cassaforma per incasso in muratura in lamiera zincata.
 Galvanized sheet housing to be recessed in brick wall or concrete.

1,80

- Minima altezza di ingombro dell'apparecchio (le quote minime del vano di incasso sono riportate sul foglio di istruzioni)

Minimum height of the appliance (see the minimum values for housing compartment in the instruction sheets)

Fotometrie disponibili www.panzeri.it / Photometric data available at www.panzeri.it

CODICI COLORI DISPONIBILI / COLOUR CODES AVAILABLE

42 gesso
plaster

21 foglia oro (a richiesta)
gold leaf (available on request)

23 foglia argento (a richiesta)
silver leaf (available on request)

24 foglia rame (a richiesta)
copper leaf (available on request)





EDDIE



NOVELTY

Piccolo faretto in alluminio ad emissione diretta per installazione ad incasso in ambienti interni. Diametro 30mm, sottilissima cornice a vista, sorgente luminosa arretrata. Disponibile in finitura bianco o nero.

Small direct-emitting aluminium spotlight for recessed indoor installations. Diameter 30 mm, recessed light source, very thin visible frame. Available in white or black finishes.

kg



XR17201.030.1715

XR17202.030.1715

Potenza assorbita apparecchio / Luminaire power consumption 2,1W
Flusso luminoso apparecchio / Luminaire luminous flux 180lm
2700K Ra>90 25° 700mA DC

IP20

XR17201.030.2515

XR17202.030.2515

Potenza assorbita apparecchio / Luminaire power consumption 2,1W
Flusso luminoso apparecchio / Luminaire luminous flux 180lm
3000K Ra>90 25° 700mA DC

IP20

+ Electric options

(see details on page 300)

DRIVER

YDA.070.012.A01 ★

YDR.090.013.A02 ★

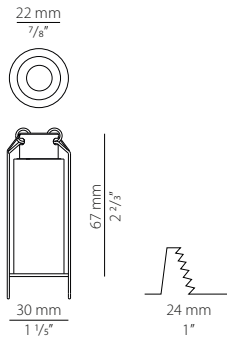

★ Dimensione dell'alimentatore maggiore del foro d'incasso, dunque installare l'alimentatore in apposito vano d'ispezione.

Power supply unit is larger than the recess hole, install the power supply unit in a special inspection compartment.

Fotometrie disponibili www.panzeri.it / Photometric data available at www.panzeri.it

CODICI COLORI DISPONIBILI / COLOUR CODES AVAILABLE

01 bianco
white

02 nero
black









JAMES



NOVELTY

Faretto ad incasso ad emissione diretta con fascio 24° in alluminio pressofuso per ambienti interni con controsoffitto. Sorgente luminosa arretrata con possibilità di orientamento del fascio di luce, fino ad un angolo massimo di 30°. Grado di protezione IP44, impermeabile agli schizzi. Disponibile in finitura bianco o nero.

Die-casted aluminium recessed spotlight with direct emission and 24° beam angle, for indoor application in false ceiling. Recessed light source with the possibility of orienting the light beam up to a maximum angle of 30°. IP44 protection degree, splash-proof. Available in white or black finishes.

kg



XR17701.040.1715

XR17702.040.1715

Potenza assorbita apparecchio / Luminaire power consumption 5,2W
Flusso luminoso apparecchio / Luminaire luminous flux 465lm
2700K Ra>90 24° 300mA DC

IP44

XR17701.040.2515

XR17702.040.2515

Potenza assorbita apparecchio / Luminaire power consumption 5,2W
Flusso luminoso apparecchio / Luminaire luminous flux 465lm
3000K Ra>90 24° 300mA DC

IP44

+ Electric options

(see details on page 300)

DRIVER

XM6-15 UNI *

YDR.035.008.A02

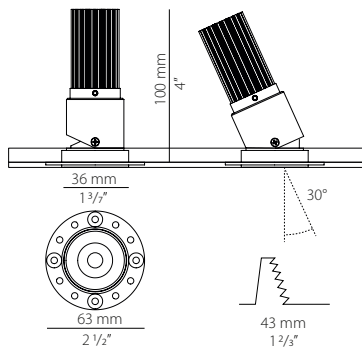

* Dimensione dell'alimentatore maggiore del foro d'incasso, dunque installare l'alimentatore in apposito vano d'ispezione.

Power supply unit is larger than the recess hole, install the power supply unit in a special inspection compartment.

Fotometrie disponibili www.panzeri.it / Photometric data available at www.panzeri.it

CODICI COLORI DISPONIBILI / COLOUR CODES AVAILABLE

01 bianco
white

02 nero
black



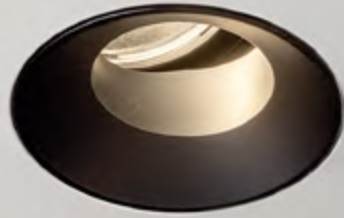







JARVIS



Faretti in alluminio per installazione incassata con cornice a vista ed emissione simmetrica, oppure per incasso a scomparsa con fascio orientabile.
Disponibili con finitura interna bianca o nera satinata, con o senza sorgente LED GU10. Possibilità di installare sorgente spot LED.

Aluminium downlights for recessed use with visible frame and symmetric light emission, or fully recessed with adjustable beam.
Inside part available in white or mat black, with or without GU10 LED lamp. Spot LED available.

NOVELTY



XR13001.070.2201
XR13006.070.2201
XM3 lampholder with terminal block max 10W GU10
LED retrofit bulb 7,5W GU10 3000K 60° Ra80 608lm (no dimming)
Lampadina inclusa / Included bulb

IP20

XR13001.070.0000
XR13006.070.0000
XM3 lampholder with terminal block max 10W GU10
senza lampadina / without bulb

IP20

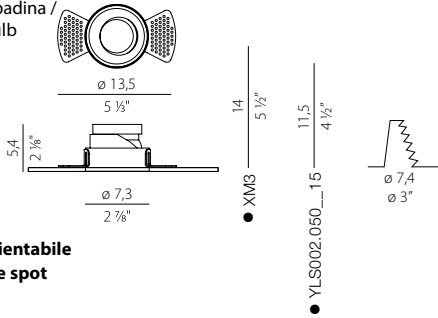

Faretto orientabile
Adjustable spot



+ Electric options
(see details on page 300)

LAMP
YLS002.050__15 spot LED
XM2 lampholder with terminal block

DRIVER
XM6-20 UNI
YDR.035.012.A02

kg
0,19

0,15



XR13101.085.2201
XR13106.085.2201
XM3 lampholder with terminal block max 10W GU10
LED retrofit bulb 7,5W GU10 3000K 60° Ra80 608lm (no dimming)
Lampadina inclusa / Included bulb

IP20

XR13101.085.0000
XR13106.085.0000
XM3 lampholder with terminal block max 10W GU10
senza lampadina / without bulb

IP20

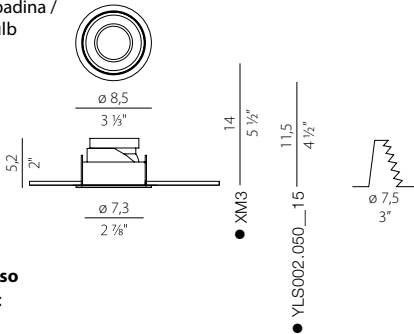

Faretto fisso
Fixed spot



+ Electric options
(see details on page 300)

LAMP
YLS002.050__15 spot LED
XM2 lampholder with terminal block

DRIVER
XM6-20 UNI
YDR.035.012.A02

0,17

0,13



● Minima altezza di ingombro dell'apparecchio (le quote minime del vano di incasso sono riportate sul foglio di istruzioni) Minimum height of the appliance (see the minimum values for housing compartment in the instruction sheets)

Fotometrie disponibili www.panzeri.it / Photometric data available at www.panzeri.it

CODICI COLORI DISPONIBILI / COLOUR CODES AVAILABLE

- 01 bianco white
- 06 nero satinato mat black





JESSIE



NOVELTY

Faretto ad incasso ad emissione diretta con fascio 24° in alluminio pressofuso per ambienti interni. La struttura si presta per l'installazione in controsoffitti con altezze ridotte, min. 70mm (2,8"). Sorgente luminosa arretrata. Disponibile in finitura bianco o nero.

Die-casted aluminium recessed spotlight with direct emission and 24° beam angle, for indoor application. The structure lends itself to installations in low false ceiling heights, min. 70mm (2,8"). Recessed light source. Available in white or black finishes.

kg

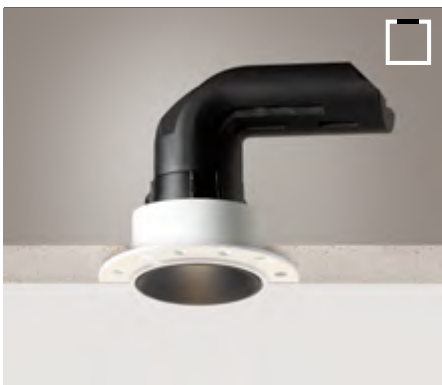

XR17401.040.1715

XR17402.040.1715

Potenza assorbita apparecchio / Luminaire power consumption 5,2W
Flusso luminoso apparecchio / Luminaire luminous flux 465lm
2700K Ra>90 24° 300mA DC

IP20

XR17401.040.2515

XR17402.040.2515

Potenza assorbita apparecchio / Luminaire power consumption 5,2W
Flusso luminoso apparecchio / Luminaire luminous flux 465lm
3000K Ra>90 24° 300mA DC

IP20

+ Electric options

(see details on page 300)

DRIVER

XM6-15 UNI *****

YDR.035.008.A02

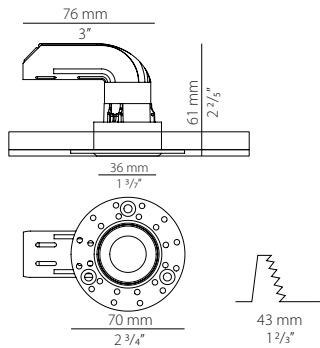

***** Dimensione dell'alimentatore maggiore del foro d'incasso, dunque installare l'alimentatore in apposito vano d'ispezione.

Power supply unit is larger than the recess hole, install the power supply unit in a special inspection compartment.

Fotometrie disponibili www.panzeri.it / Photometric data available at www.panzeri.it

CODICI COLORI DISPONIBILI / COLOUR CODES AVAILABLE

01 bianco
white

02 nero
black







MARK

Matteo Italia - Italia and Partners 2020



Incasso rettangolare in metallo con emissione di luce indiretta a LED disponibile in tre dimensioni, adatto anche ad un utilizzo come segnapasso. Le dimensioni del prodotto sono minimali per consentirne l'installazione anche in presenza di profondità di incasso a soffitto e a parete ridotte. Cornice disponibile in finitura bianco, nero, titanio, bronzo e ottone satinato.

Metal sheet recessed LED downlight with indirect light available in three sizes, suitable as floor washer light. Minimal product height in order to allow mounting in case of reduced recessed space in wall and ceiling. The frame is available in white, black, titanium, bronze and mat brass finishes.



- X01701.030.0410
- X01702.030.0410
- X01717.030.0410
- X01719.030.0410
- X01730.030.0410

Potenza assorbita apparecchio / Luminaire power consumption 8,5W
Flusso luminoso apparecchio / Luminaire luminous flux 362lm
3000K Ra>90 24V DC

LED IP20

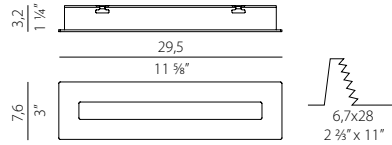

+ Electric options
(see details on page 300)

- DRIVER
- XM6-20 UNI
- YDV.024.030.A01
- YDV.024.060.A01
- YDV.024.120.A01
- YDV.024.180.A01
- XM18/24DIM
- XM35/24 DIM
- XM60/24 DIM
- XM100/24 DIM
- XM150/24 DIM

kg

0,60

YCF01700.030 164x287x68mm

Cassaforma per incasso in muratura in lamiera zincata.
Galvanized sheet housing to be recessed in brick wall or concrete.

0,93



- X01701.055.0410
- X01702.055.0410
- X01717.055.0410
- X01719.055.0410
- X01730.055.0410

Potenza assorbita apparecchio / Luminaire power consumption 17W
Flusso luminoso apparecchio / Luminaire luminous flux 723lm
3000K Ra>90 24V DC

LED IP20

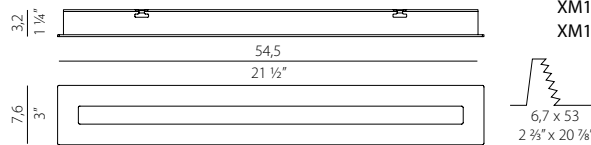

+ Electric options
(see details on page 300)

- DRIVER
- YDV.024.030.A01
- YDV.024.060.A01
- YDV.024.120.A01
- YDV.024.180.A01
- XM18/24DIM
- XM35/24 DIM
- XM60/24 DIM
- XM100/24 DIM
- XM150/24 DIM

1,05

YCF01700.055 164x537x68mm

Cassaforma per incasso in muratura in lamiera zincata.
Galvanized sheet housing to be recessed in brick wall or concrete.

1,62

Fotometrie disponibili www.panzeri.it / Photometric data available at www.panzeri.it

CODICI COLORI DISPONIBILI / COLOUR CODES AVAILABLE

- 01 bianco white
- 02 nero black
- 17 bronzo bronze
- 19 ottone satinato mat brass
- 30 titanio titanium











NICK



Incasso rotondo in pressofusione di alluminio a dissipazione passiva con LED COB integrato in colore bianco. A richiesta riflettori con diverse aperture del fascio luminoso.

Round recessed spotlight in die-cast aluminium with passive thermal dissipation equipped with integrated LED COB finished in white colour. On request optics with different light beams.



XR25401.040.1815

Potenza assorbita apparecchio / Luminaire power consumption 4,5W
Flusso luminoso apparecchio / Luminaire luminous flux 399lm
2700K Ra>90 60° 500mA DC

+ Electric options
(see details on page 300)

kg

0,10

XR25401.040.2615

Potenza assorbita apparecchio / Luminaire power consumption 4,5W
Flusso luminoso apparecchio / Luminaire luminous flux 425lm
3000K Ra>90 60° 500mA DC

DRIVER
XM6-20 UNI ★
XM6-20 D/P MULTI ★

0,10

IP43 IP20 IK07 850°

Protezione contro l'inversione di polarità
Reverse polarity protection

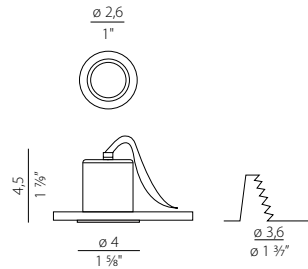

XR22501.050.2515

Potenza assorbita apparecchio / Luminaire power consumption 6,5W
Flusso luminoso apparecchio / Luminaire luminous flux 455lm
3000K Ra>90 34° 700mA DC

+ Electric options
(see details on page 300)

0,10

IP65 IP20 IK08 850°

DRIVER
XM6-20 UNI ★
XM6-20 D/P MULTI ★
XM6-25 D/P MULTI ★

Protezione contro l'inversione di polarità
Reverse polarity protection

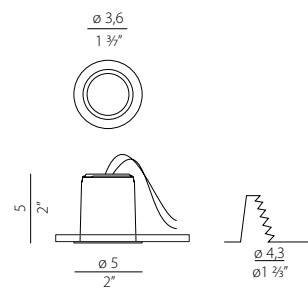



I Driver non sono inclusi, vedi electric options.
Da acquistare separatamente.

Drivers not included, see electric options.
Please purchase separately.

* Dimensione dell'alimentatore maggiore del foro d'incasso,
dunque installare l'alimentatore in apposito vano d'ispezione.

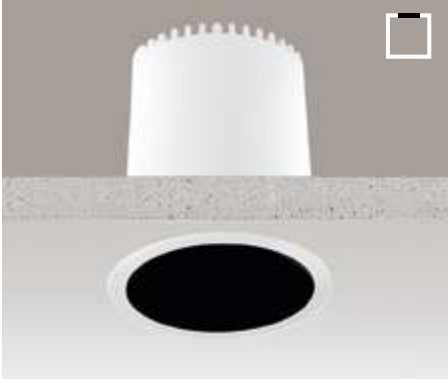
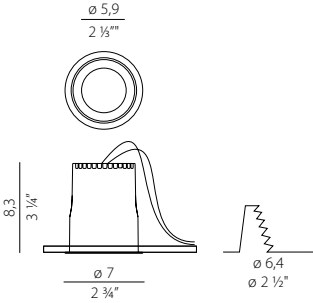
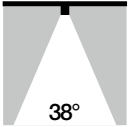
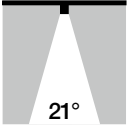
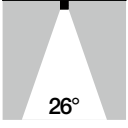
Power supply unit is larger than the recess hole, install the
power supply unit in a special inspection compartment.

		kg
	XR26201.060.1715 Potenza assorbita apparecchio / Luminaire power consumption 9W/12W Flusso luminoso apparecchio / Luminaire luminous flux 609lm/830lm 2700K Ra>90 38° 250/350mA DC	0,30
	XR26201.060.2515 Potenza assorbita apparecchio / Luminaire power consumption 9W/12W Flusso luminoso apparecchio / Luminaire luminous flux 632lm/852lm 3000K Ra>90 38° 250/350mA DC LED IP43 IP20 IK08 850°	0,30
+ Electric options (see details on page 300)		
DRIVER XM6-15 UNI XM6-20 UNI XM6-20 D/P MULTI XM6-25 D/P MULTI		
Protezione contro l'inversione di polarità Reverse polarity protection		
I Driver non sono inclusi, vedi electric options. Da acquistare separatamente. Drivers not included, see electric options. Please purchase separately.		
		
	STANDARD Ottica per fascio medio. Flood optic.	
	XMR5 Ottica per fascio stretto. Spot optic.	
	XMR6 Ottica per fascio medio. Flood optic.	
	XMR9 Cilindro interno colore oro satinato. Internal satin gold cylinder.	
Fotometrie disponibili www.panzeri.it / Photometric data available at www.panzeri.it		
CODICI COLORI DISPONIBILI / COLOUR CODES AVAILABLE		
01 bianco white		



RALLY TRIM



NOVELTY

Serie di incassi rettangolari ad emissione diretta con cornice in alluminio pressofuso per ambienti interni, disponibile in tre versioni con lunghezze differenti, in finitura bianca con ottiche nere. La sorgente luminosa arretrata è costituita da moduli LED accoppiati a lenti con fascio di 30°.

Series of rectangular direct-emitting die-casted aluminium downlights with frame for indoor application, available in three versions with different lengths, in white finish with black optics. The recessed light source is made of LED modules coupled with lenses with 30° beam angle.

kg



XR17801.007.1715

Potenza assorbita apparecchio / Luminaire power consumption 3,6W
Flusso luminoso apparecchio / Luminaire luminous flux 240lm
2700K Ra>90 30° 600mA DC

LED IP20

XR17801.007.2515

Potenza assorbita apparecchio / Luminaire power consumption 3,6W
Flusso luminoso apparecchio / Luminaire luminous flux 240lm
3000K Ra>90 30° 600mA DC

LED IP20

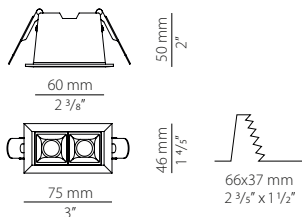

+ Electric options

(see details on page 300)

DRIVER

XM6-20 UNI

XM6-20 D/P MULTI

YDR.090.013.A02

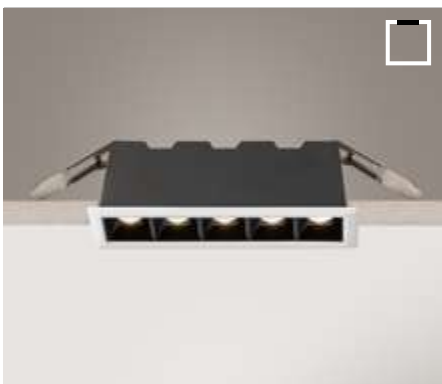

XR17801.014.1715

Potenza assorbita apparecchio / Luminaire power consumption 9W
Flusso luminoso apparecchio / Luminaire luminous flux 602lm
2700K Ra>90 30° 600mA DC

LED IP20

XR17801.014.2515

Potenza assorbita apparecchio / Luminaire power consumption 9W
Flusso luminoso apparecchio / Luminaire luminous flux 602lm
3000K Ra>90 30° 600mA DC

LED IP20

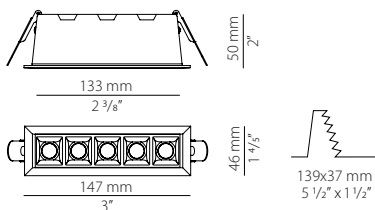

+ Electric options

(see details on page 300)

DRIVER



XM6-20 UNI

XM6-20 D/P MULTI

YDR.090.013.A02

**XR17801.028.1715**

Potenza assorbita apparecchio / Luminaire power consumption 18W
 Flusso luminoso apparecchio / Luminaire luminous flux 1204lm
 2700K Ra>90 30° 600mA DC

 **IP20** 

XR17801.028.2515

Potenza assorbita apparecchio / Luminaire power consumption 18W
 Flusso luminoso apparecchio / Luminaire luminous flux 1204lm
 3000K Ra>90 30° 600mA DC

 **IP20** 

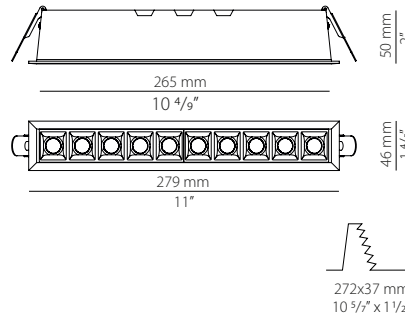

Fotometrie disponibili www.panzeri.it / Photometric data available at www.panzeri.it

CODICI COLORI DISPONIBILI / COLOUR CODES AVAILABLE

01 bianco
white









SID



Piccolo faretto in alluminio ad emissione diretta per installazione ad incasso in ambienti interni. Diametro 20mm, sottilissima cornice a vista, sorgente luminosa arretrata. Disponibile in finitura bianco o nero.

Small direct-emitting aluminium spotlight for recessed indoor installations. Diameter 20 mm, recessed light source, very thin visible frame. Available in white or black finishes.

NOVELTY

kg

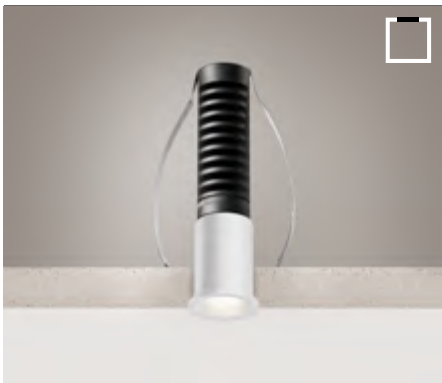

XR17001.020.1715

XR17002.020.1715

Potenza assorbita apparecchio / Luminaire power consumption 2,1W
Flusso luminoso apparecchio / Luminaire luminous flux 180lm
2700K Ra>90 25° 700mA DC

IP20

XR17001.020.2515

XR17002.020.2515

Potenza assorbita apparecchio / Luminaire power consumption 2,1W
Flusso luminoso apparecchio / Luminaire luminous flux 180lm
3000K Ra>90 25° 700mA DC

IP20

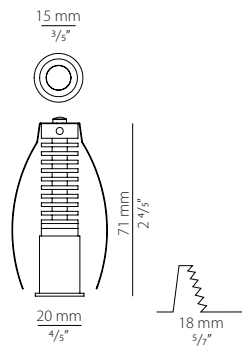

+ Electric options

(see details on page 300)

DRIVER

YDA.070.012.A01 *

YDR.090.013.A02 *

* Dimensione dell'alimentatore maggiore del foro d'incasso, dunque installare l'alimentatore in apposito vano d'ispezione.

Power supply unit is larger than the recess hole, install the power supply unit in a special inspection compartment.

Fotometrie disponibili www.panzeri.it / Photometric data available at www.panzeri.it

CODICI COLORI DISPONIBILI / COLOUR CODES AVAILABLE

01 bianco
white

02 nero
black



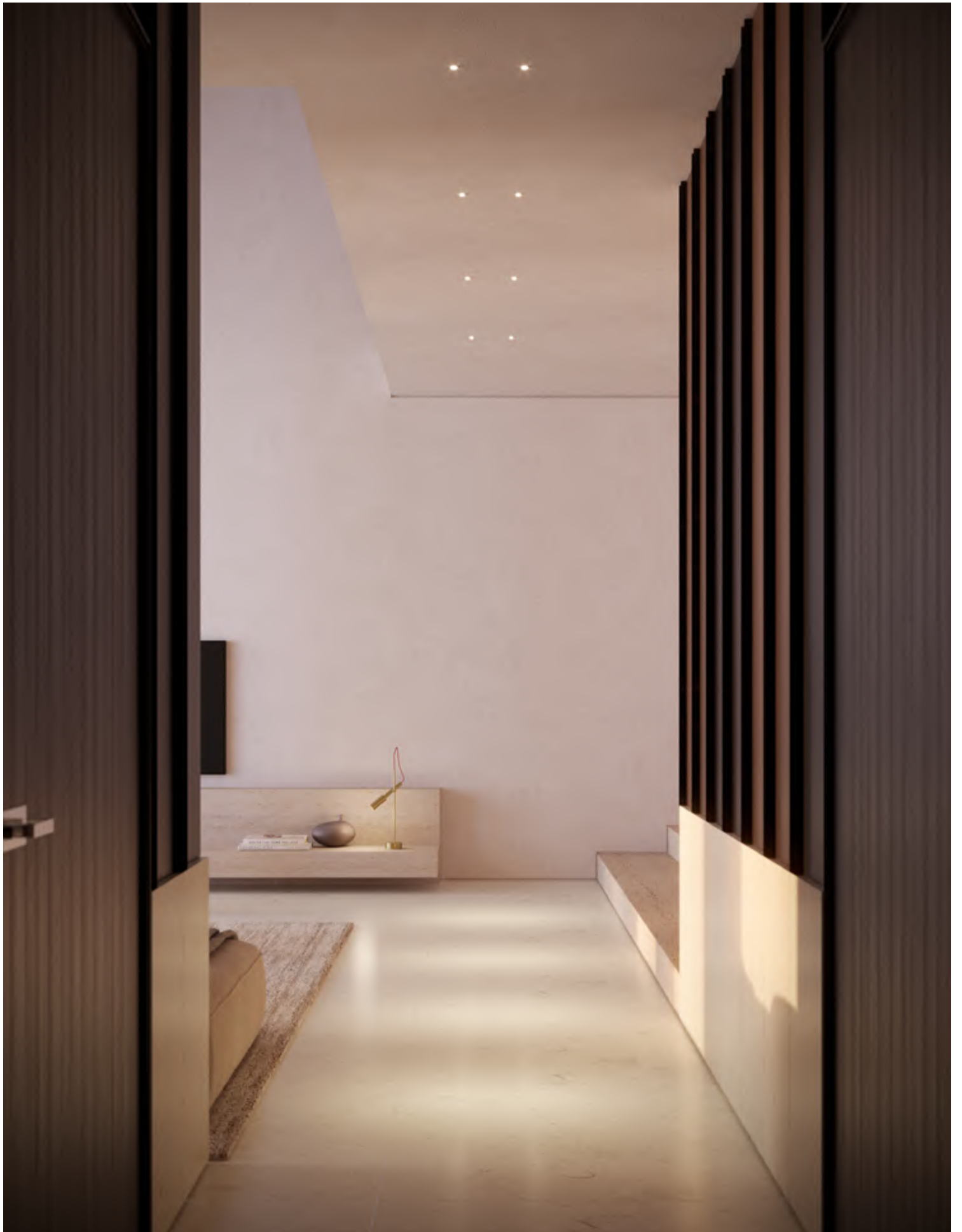



TAYLOR



Incasto orientabile per interni, equipaggiato con LED COB di ultima generazione. È disponibile in versione a luce calda con accessori ottici intercambiabili, per un'illuminazione sia d'accento che diffusa. La parte mobile rimane nascosta nel controsoffitto. Il design professionale e la cornice sottile disponibile in diverse finiture rendono Taylor la soluzione ideale in progetti di retail, showroom e hospitality. L'ottica è arretrata per un basso livello di abbagliamento, così da garantire un migliore comfort visivo. La profondità di incasso è contenuta e consente una semplice e veloce installazione anche in spazi ristretti. Disponibile nelle finiture bianco, nero, bronzo, ottone satinato e titanio. Driver da acquistare separatamente.

Adjustable downlight for indoors, equipped with COB LED of latest generation. Available in white warm light with optical accessories interchangeable, for a diffused or accent illumination. The adjustable part is hidden within the false ceiling. The professional design and the minimal frame available in different finishes make Taylor the ideal solution for various projects, from retail stores or show-rooms to hospitality. The lens is recessed for low glaring, in order to provide an enhanced visual comfort. The minimal depth of recess allows a simple and quick installation also in false ceilings of limited spaces. Available in finish white, black, bronze, mat brass and titanium. Driver to order separately.

	kg
	0,40

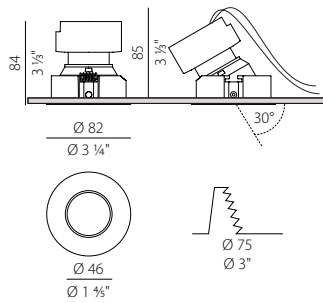

X16801.008.2515

X16802.008.2515

X16817.008.2515

X16819.008.2515

X16830.008.2515

Potenza assorbita apparecchio / Luminaire power consumption 12W
 Flusso luminoso apparecchio / Luminaire luminous flux 824lm
 3000K Ra>90 38° 360mA DC

IP43 IP20 IK08 850°

+ Electric options
 (see details on page 300)

DRIVER
 XM6-15 UNI
 XM6-20 D/P MULTI
 XM6-25 D/P MULTI

I Driver non sono inclusi, vedi electric options.
 Da acquistare separatamente.
 Drivers not included, see electric options.
 Please purchase separately.

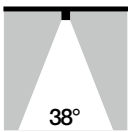

STANDARD
 Ottica per fascio medio.
 Flood optic.

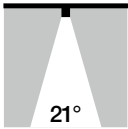

XMR5
 Ottica per fascio stretto.
 Spot optic.

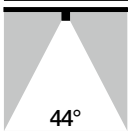

XMR8
 Ottica per fascio largo.
 Wide flood optic.

Fotometrie disponibili www.panzeri.it / Photometric data available at www.panzeri.it

CODICI COLORI DISPONIBILI / COLOUR CODES AVAILABLE

01 bianco
white

02 nero
black

17 bronzo
bronze

19 ottone satinato
mat brass

30 titanio
titanium







JOE



Faretto da incasso in alluminio, bianco o nero con o senza sorgente GU10 LED Spot.

Aluminium recessed spotlight in white or black colour with or without GU10 LED Spot lamp.



XA2115

XA2115 BLA

XM3 lampholder with terminal block max 50W GU10 LED retrofit bulb 7,5W GU10 3000K 60° Ra80 608lm (no dimming) * IP20

ST.XA2115

ST.XA2115 BLA

XM3 lampholder with terminal block max 50W GU10 senza lampadina without bulb

IP20

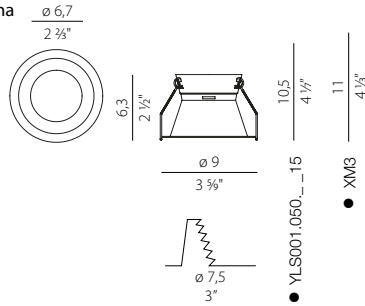

* Lampadina inclusa / Included bulb

kg

0,09



0,09

+ Electric options

(see details on page 300)

LAMP

YLS001.050._15 spot LED

DRIVER

XM6-15 UNI

XM6-20 UNI

XM6-20 D/P MULTI

XM6-25 D/P MULTI



XA2116

XA2116 BLA

XM3 lampholder with terminal block max 50W GU10 LED retrofit bulb 7,5W GU10 3000K 60° Ra80 608lm (no dimming) * IP20

ST.XA2116

ST.XA2116 BLA

XM3 lampholder with terminal block max 50W GU10 senza lampadina without bulb

IP20

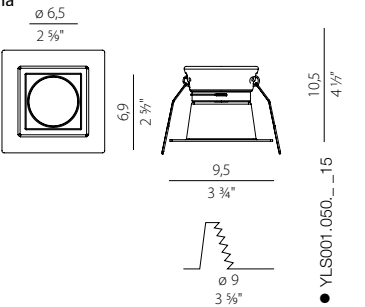

* Lampadina inclusa / Included bulb

0,12



0,12

+ Electric options

(see details on page 300)

LAMP

YLS001.050._15 spot LED

DRIVER

XM6-15 UNI

XM6-20 UNI

XM6-20 D/P MULTI

XM6-25 D/P MULTI

● Minima altezza di ingombro dell'apparecchio (le quote minime del vano di incasso sono riportate sul foglio di istruzioni)

Minimum height of the appliance (see the minimum values for housing compartment in the instruction sheets)

Fotometrie disponibili www.panzeri.it / Photometric data available at www.panzeri.it

CODICI COLORI DISPONIBILI / COLOUR CODES AVAILABLE

bianco white **BLA** nero black



ROY



Incasso rotondo in pressofusione di alluminio IP43 a dissipazione passiva con LED COB integrato in colore bianco e a richiesta ottiche con diversi fasci luminosi.

Round spotlight in die-cast aluminium IP43 with passive thermal dissipation equipped with integrated LED COB finished in white colour and on request optics with different light beams.



XR255-43-3K

Potenza assorbita apparecchio / Luminaire power consumption 12W/18W
Flusso luminoso apparecchio / Luminaire luminous flux 1513lm/2092lm
3000K Ra>85 55° 350/500mA DC

+ Electric options
(see details on page 300)

kg
0,59

XR255-43-4K

Potenza assorbita apparecchio / Luminaire power consumption 12W/18W
Flusso luminoso apparecchio / Luminaire luminous flux 1602lm/2180lm
4000K Ra>85 55° 350/500mA DC

DRIVER
XM6-20 UNI
XM6-20 D/P MULTI
XM6-25 D/P MULTI

0,59

LED IP43 IP20 IK08 850°

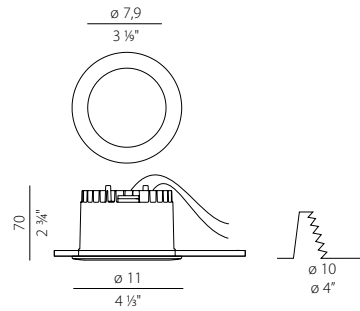

Protezione contro l'inversione di polarità
Reverse polarity protection

I Driver non sono inclusi, vedi electric options. Da acquistare separatamente.
Drivers not included, see electric options. Please purchase separately.

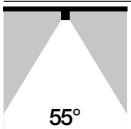

STANDARD

Ottica per fascio largo.
Wide flood optic.

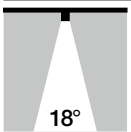

XMR1

Ottica per fascio stretto.
Spot optic.

0,02

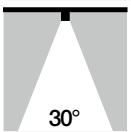

XMR2

Ottica per fascio medio.
Flood optic.

0,03

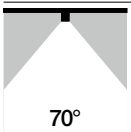

XMR4

Ottica per fascio diffuso.
Diffused beam optic.

0,02

Fotometrie disponibili www.panzeri.it / Photometric data available at www.panzeri.it

CODICI COLORI DISPONIBILI / COLOUR CODES AVAILABLE

01 bianco
white

LED PANEL

JERSEY



Pannello LED di dimensione 595x595mm con spessore ridotto ed elevata efficienza luminosa, disponibile per luce in tonalità bianco naturale. L'innovativa ottica in PMMA del diffusore è adatta all'utilizzo in uffici con videotermini e permette un illuminamento omogeneo, creando un ambiente confortevole. Versione base installabile in appoggio sui traversini dei controsoffitti a pannelli con struttura a vista, oppure incassabile in controsoffitti a struttura nascosta o continui tramite appositi accessori. Cornice per eventuale installazione a plafone da ordinare a parte. Fornito completo di driver ON-OFF oppure con driver dimmerabile DALI. Kit di emergenza acquistabile separatamente.

LED panel in dimension 595x595mm with limited thickness and high luminous efficacy, available in natural white light.

The innovative optic in PMMA of the diffuser makes it suitable for use in workspaces with monitors and allows a homogeneous illumination, creating a comfortable environment. Base version to install onto the modular metal ceiling with visible structure. Accessory available for installation in modular metal ceiling with hidden structure. Frame for installation as a surface mount available as an option.

Supplied with a ON-OFF driver or DALI dimming. Emergency kit to order separately.

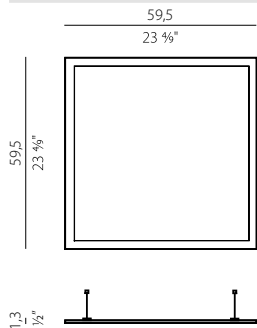

CODICE CODE	FONTI LUMINOSE LIGHT SOURCES	kg	
X33547.060.0301	Potenza assorbita apparecchio / Luminaire power consumption 35W Flusso luminoso LED / LED luminous flux 3527lm 4000K Ra>80 220-240V AC ON-OFF IP40 IK05	3,85	on request
X33547.060.0320	Potenza assorbita apparecchio / Luminaire power consumption 35W Flusso luminoso LED / LED luminous flux 3527lm 4000K Ra>80 220-240V AC dimmable DALI IP40 IK05	4,04	on request
XM33500.402.0007	Kit emergenza 3h Emergency kit 3h		on request
XM33500.201.0099	Kit 4 molle per incasso in battuta su controsoffitti in cartongesso Kit for ceiling mounting in plaster board false ceiling		on request
XM33500.202.0099	Telaio per montaggio in controsoffitto modulare metallico con struttura nascosta Frame for mounting in modular metal false ceiling with hidden structure		on request
XM33500.203.0099	Telaio per montaggio in controsoffitto in cartongesso Frame for mounting in plaster board false ceiling		on request
XM33501.204.0099	Cornice per montaggio a plafone Frame for ceiling mounting		on request

Fotometrie disponibili www.panzeri.it / Photometric data available at www.panzeri.it UGR<19 in funzione delle condizioni di installazione / UGR<19 depending on installation conditions

CODICI COLORI DISPONIBILI / COLOUR CODES AVAILABLE

01 Bianco White	47 Bianco + diffusore microprismato White + microprismatic diffusers
---------------------------	--

ELECTRIC OPTIONS





- 300 ELECTRIC OPTIONS
- 305 TECHNICAL INFORMATION
- 308 FONDAMENTI DI ILLUMINOTECNICA / LIGHTING BASICS

ELECTRIC OPTIONS

COMPONENTI ELETTRICI / ELECTRICAL COMPONENTS

XM3

LAMPHOLDER + TERMINAL BLOCK

MAX 50W GU10 
 OR GU10 FLUO 
 OR LED LAMP GU10 
 IP20  

LED CORRENTE COSTANTE / LED CONSTANT CURRENT

YLS001.050.1715 (2700K)
 YLS001.050.2515 (3000K)
 YLS001.050.2915 (4000K)

LED 8,5W 250mA 35V 35° Ra>90
 Flusso luminoso apparecchio
 Luminaire luminous flux:
 2700K - 806lm
 3000K - 854lm
 4000K - 1053lm



TECHNICAL INFORMATION	WIRING DIAGRAM 4
PAG. 305	PAG. 306

See matrix page 304



YLS002.050.1715 (2700K)
 YLS002.050.2515 (3000K)

NOVELTY

LED 12W 350mA 35V 36° Ra>90
 Flusso luminoso apparecchio
 Luminaire luminous flux:
 2700K - 1140lm
 3000K - 1170lm



TECHNICAL INFORMATION	WIRING DIAGRAM 4
PAG. 305	PAG. 306

See matrix page 304



LED TENSIONE COSTANTE / LED CONSTANT VOLTAGE

XM006.050.0410

Modulo / module 500 mm 64LED
 8,6W 3000K Ra90 24V 285lm
 62,5mm **2280 lm/m**



TECHNICAL INFORMATION	WIRING DIAGRAM 1
PAG. 305	PAG. 305

See Matrix page 304

500 x 14 mm
 19 3/8" x 5/8"



XM006.012.0410

Modulo / module 125 mm 16LED
 2,15W 3000K Ra90 24V 285lm
 62,5mm **2280 lm/m**



TECHNICAL INFORMATION	WIRING DIAGRAM 1
PAG. 305	PAG. 305

See Matrix page 304

125 x 14 mm
 5" x 5/8"



YLR001.022.0110

STRIP ROLL 5 m 3000K Ra80 24V
 50 mm
 5 x 160 LED/m - 5 x 21,6 W/m
 5 x **3020 lm/m**



TECHNICAL INFORMATION	WIRING DIAGRAM 1
PAG. 305	PAG. 305

See Matrix page 304

5000 x 10 mm
 197" x 3/8"



YLR002.017.0510 (2700K)
 YLR002.017.0410 (3000K)
 YLR002.017.0610 (4000K)

STRIP ROLL 5 m 2700/3000/4000K Ra90 24V
 42 mm
 5 x 168 LED/m - 5 x 17,3 W/m
 5 x **1700 lm/m** (2700K)
 5 x **1810 lm/m** (3000K)
 5 x **1920 lm/m** (4000K)



TECHNICAL INFORMATION	WIRING DIAGRAM 2
PAG. 305	PAG. 305

See Matrix page 304

5000 x 10 mm
 197" x 3/8"



YLR003.010.0510 (2700K)
 YLR003.010.0410 (3000K)
 YLR003.010.0610 (4000K)

STRIP ROLL 5 m 2700/3000/4000K Ra90 24V
 42 mm
 5 x 168 LED/m - 5 x 9,6 W/m
 5 x **882 lm/m** (2700K)
 5 x **930 lm/m** (3000K)
 5 x **980 lm/m** (4000K)



TECHNICAL INFORMATION	WIRING DIAGRAM 2
PAG. 305	PAG. 305

See Matrix page 304

5000 x 10 mm
 197" x 3/8"



YLR004.014.0410

STRIP ROLL IP67 5 m 3000K Ra90 24V
 50 mm
 5 x 160 LED/m - 5 x 14,4 W/m
 5 x **1585 lm/m**



TECHNICAL INFORMATION	WIRING DIAGRAM 1
PAG. 305	PAG. 305

See Matrix page 304

5000 x 10 mm
 197" x 3/8"



SORGENTI LED / LED LAMP 220-240V

YLL001.050.2201

7,5W GU10 Ø 50 mm 3000K Ra80 608lm 60° 220-240V NOT DIMMABLE



YLL002.050.2201

7,5W GU10 Ø 50 mm 3000K Ra80 608lm 60° 220-240V NOT DIMMABLE



XM5/GU10-35

4W GU10 Ø 35 mm 3000K Ra80 340lm 220-240V NOT DIMMABLE



XM5/G9LED



4W G9 3000K Ra80 330lm 110-240V NOT DIMMABLE



LED DRIVER CORRENTE COSTANTE / LED DRIVER CONSTANT CURRENT

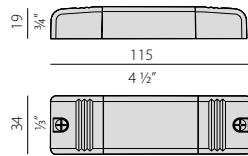

XM6-15 UNI

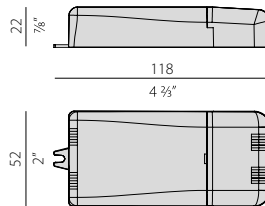

V in 100-240V AC
 V out 2-41,5V DC
 I out 60-360mA
 W 2,5-15
 λ 0,80
  SELV
 See Matrix page 304

XM6-20 UNI





V in 220-240V AC
 V out 2-54V DC
 I out 250-700mA
 W 4-20
 λ 0,95
  SELV
 See Matrix page 304

YDA.070.012.A01

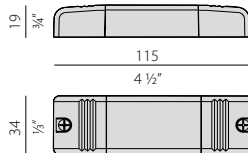
NOVELTY



V in 220-240V AC
 V out 2-16V DC
 I out 700mA
 W 12
 λ 0,85
  SELV
 See Matrix page 304

ELECTRIC OPTIONS

LED DRIVER CORRENTE COSTANTE DIMMERABILE / LED DRIVER DIMMABLE CONSTANT CURRENT

YDR.035.008.A02

NOVELTY

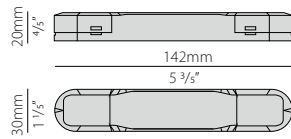

V in 220-240V AC
V out 5-42V DC
I out 120-350mA
W 5-8,4
 λ 0,95

See Matrix page 304

YDR.035.012.A02

NOVELTY

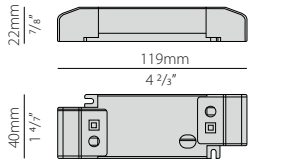

V in 220-240V AC
V out 9-42V DC
I out 120-350mA
W 5-14,7
 λ 0,95

See Matrix page 304

YDR.050.012.A02

NOVELTY

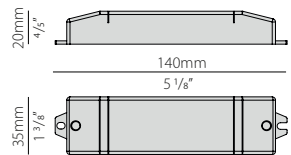

V in 220-240V AC
V out 6-40V DC
I out 200-500mA
W 8-10
 λ \geq 0,90

See Matrix page 304

YDR.090.013.A02

NOVELTY

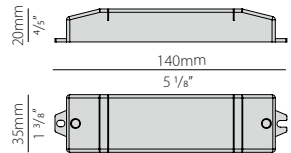

V in 220-240V AC
V out 24V DC
I out 600-900mA
W 9,6-9,9
 λ \geq 0,90

See Matrix page 304

XM6-20 D/P MULTI

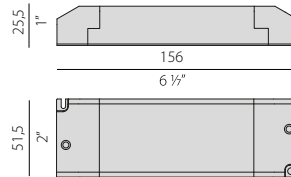

V in 220-240V AC
V out 3-46V DC
I out 200-900mA
W 9,2-28
 λ \geq 0,95

See Matrix page 304

XM6-25 D/P MULTI

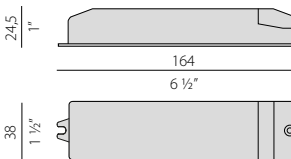

V in 220-240V AC
V out 3-55V DC
I out 200-900mA
W 11-25,6
 λ \geq 0,92

See Matrix page 304

LED DRIVER TENSIONE COSTANTE 48V / LED DRIVER CONSTANT VOLTAGE 48V

YDV.048.075.A01

NOVELTY

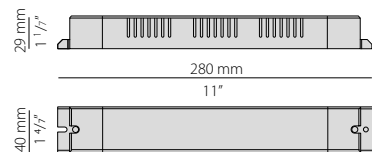

V in 220-240V AC
V out 48V DC
I out 1,55A DC
W 75
 λ \geq 0,96

YDV.048.150.A01

NOVELTY

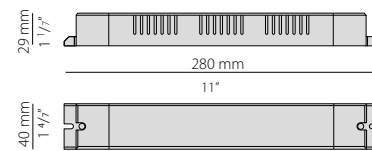

V in 220-240V AC
V out 48V DC
I out 3,125A DC
W 150
 λ \geq 0,96





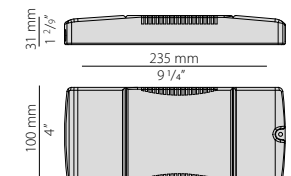





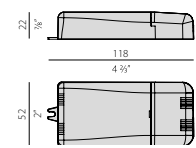

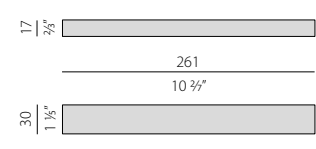
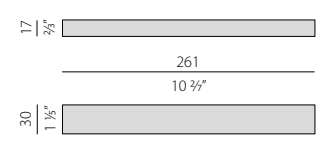
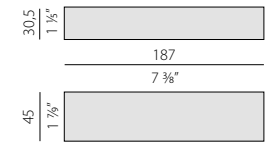

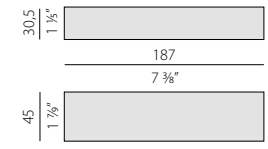

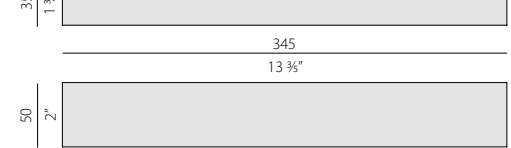
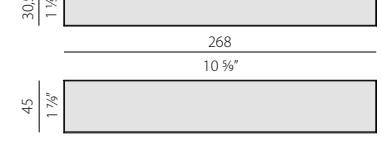
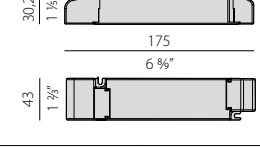
YDV.048.150.A02

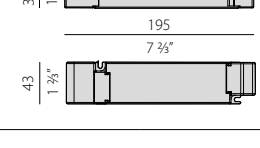
NOVELTY

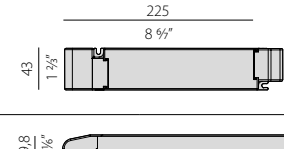
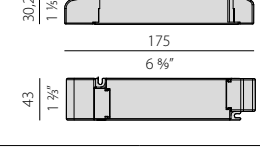
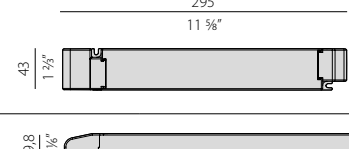
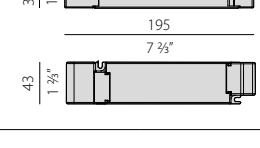
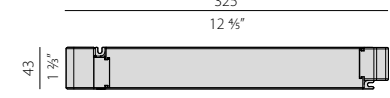
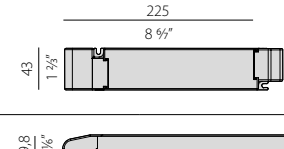

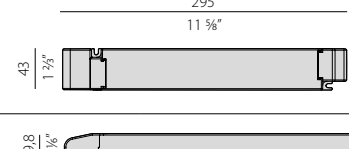
V in 220-240V AC
V out 48V DC
I out 3,125A DC
W 150
 λ 0,99

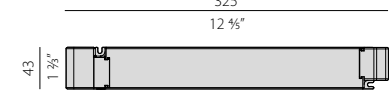
LED DRIVER TENSIONE COSTANTE 24V / LED DRIVER CONSTANT VOLTAGE 24V

XM6-20 UNI		<p>V in 220-240V AC V out 24V DC I out 700mA DC W 16 λ 0,97</p> <p>  SELV</p> <p>See Matrix page 304</p>
YDV.024.030.A01		<p>V in 220-240V AC V out 24V DC I out 1,25A DC W 30 λ ≥ 0,95</p> <p>  SELV</p> <p>See Matrix page 304</p>
YDV.024.060.A01		<p>V in 220-240V AC V out 24V DC I out 2,5A DC W 60 λ 0,9</p> <p>  SELV</p> <p>See Matrix page 304</p>
YDV.024.120.A01		<p>V in 220-240V AC V out 24V DC I out 5A DC W 120 λ 0,9</p> <p>  SELV</p> <p>See Matrix page 304</p>
YDV.024.180.A01		<p>V in 220-240V AC V out 24V DC I out 7,5A DC W 180 λ 0,95</p> <p>  SELV</p> <p>See Matrix page 304</p>
XM18/24 DIM		<p>V in 220-240V AC V out 24V DC I out 0,75A DC W 18 λ 0,95</p> <p> SELV PUSH DIM DALI</p> <p>See Matrix page 304</p>
XM35/24 DIM		<p>V in 220-240V AC V out 24V DC I out 1,453A DC W 35 λ 0,98</p> <p> SELV PUSH DIM DALI</p> <p>See Matrix page 304</p>
XM60/24 DIM		<p>V in 220-240V AC V out 24V DC I out 2,50A DC W 60 λ 0,98</p> <p> SELV PUSH DIM DALI</p> <p>See Matrix page 304</p>
XM100/24 DIM		<p>V in 220-240V AC V out 24V DC I out 4,167A DC W 100 λ 0,99</p> <p> SELV PUSH DIM DALI</p> <p>See Matrix page 304</p>
XM150/24 DIM		<p>V in 220-240V AC V out 24V DC I out 6,250A DC W 150 λ 0,99</p> <p> SELV PUSH DIM DALI</p> <p>See Matrix page 304</p>

ELECTRIC OPTIONS

SISTEMI DI CONTROLLO LED / LED CONTROL SYSTEM

Dispositivi per la dimmerazione di moduli LED a 12, 24 e 48V DC. Utilizzabili con alimentatore standard (non dimmerabile). E' possibile applicarli anche in impianti esistenti senza sostituire gli alimentatori già in uso.

Dimming devices for LED modules (12, 24, 48 V DC). Can be used with standard drivers (not dimmable). It's also possible to use the device in existing lighting systems without replacing the already installed drivers.

YCO.C048.A02

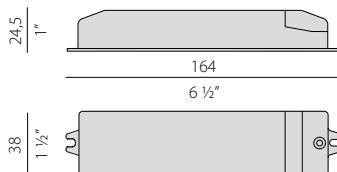

DISPOSITIVO DIMMERABILE / DIMMING DEVICE

Modalità di dimmerazione / Dimming mode:

0-10V, 1-10V, PUSH DIM, DALI

Master, slave

V in 12-48V DC

I out 12A DC

W 12V: 144W - 24V: 288W - 48V: 576W

SELV 0...10V 1...10V PUSH DIM DALI

TECHNICAL INFORMATION	WIRING DIAGRAM 6
PAG. 305	PAG. 307

See Matrix page 304

YCO.D048.A02

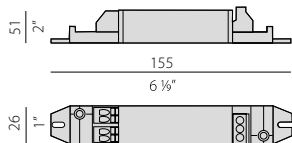

DISPOSITIVO DIMMERABILE / DIMMING DEVICE

Modalità di dimmerazione / Dimming mode:

1-10V, PUSH DIM, DALI

V in 12-48V DC

I out 6A DC

W 12V: 72W - 24V: 144W - 48V: 288W

SELV 1...10V PUSH DIM DALI

TECHNICAL INFORMATION	WIRING DIAGRAM 7
PAG. 305	PAG. 307

See Matrix page 304

MATRICE LED/DRIVER - LED/DRIVER MATRIX

MODELLO / MODEL	YLS001	YLS002	XM006	YLR001	YLR002	YLR003	YLR004	YLR101	YLR102
Constant current									
XM6-15 UNI	1	1							
XM6-20 UNI	1	1	• (24V setting)	• (24V setting)	• (24V setting)	• (24V setting)	• (24V setting)	• (24V setting)	• (24V setting)
YDA.070.012.A01									
YDA.035.008.A02									
YDR.035.012.A02	1	1							
YDR.050.012.A02	1								
YDR.090.013.A02									
XM6-20 D/P MULTI	1	1							
XM6-25 D/P MULTI	1	1							

Constant voltage									
YDV.024.030.A01			•	•	•	•	•	•	•
YDV.024.060.A01			•	•	•	•	•	•	•
YDV.024.120.A01			•	•	•	•	•	•	•
YDV.024.180.A01			•	•	•	•	•	•	•
XM18/24 DIM			•	•	•	•	•	•	•
XM35/24 DIM			•	•	•	•	•	•	•
XM60/24 DIM			•	•	•	•	•	•	•
XM100/24 DIM			•	•	•	•	•	•	•
XM150/24 DIM			•	•	•	•	•	•	•

Led control systems									
YCO.C048.A02			•	•	•	•	•	•	•
YCO.D048.A02			•	•	•	•	•	•	•

APPARECCHI CON LED A TENSIONE COSTANTE 24V DC

Le nostre strip LED sono state studiate per essere installate all'interno dei nostri prodotti: se impiegate in altre situazioni, è necessario dissipare adeguatamente il calore.

Il collegamento tra i vari apparecchi/LED deve essere effettuato in parallelo.

Nella scelta dell'alimentatore, mantenere sempre un margine aggiuntivo del 10% sulla potenza impiegata.

E' necessario considerare la distanza tra alimentatori e apparecchi/LED per limitare possibili cadute di tensione.

La tabella 1(sotto) indica la distanza massima tra alimentatore e gli apparecchi/LED in funzione della sezione del cavo e della potenza, con alimentazione a 24V DC.

FIXTURES USING LEDS WITH A CONSTANT VOLTAGE OF 24V DC

Our LED strips are designed to be installed in our products; if installed elsewhere please consider thermal management by using proper heatsinks.

The connection between the various fixtures / LEDs must be carried out in parallel. Always consider an increase of 10% on the power used defying power supply.

The distance between power supplies and fixtures / LED must be considered to limit possible voltage drop.

Table 1 (below) indicates the maximum distance between the power supply and the luminaires / LEDs according to cable section and power, with 24V DC power supply.

TABELLA 1			
W	1 mm ²	1,5 mm ²	2,5 mm ²
10	56 m	85 m	141 m
20	28 m	42 m	71 m
30	19 m	28 m	47 m
40	14 m	21 m	35 m
50	11 m	17 m	28 m
60	9 m	14 m	24 m
70	8 m	12 m	20 m
80	7 m	11 m	18 m
90	6 m	9 m	16 m
100	6 m	8 m	14 m
110	5 m	8 m	13 m
120	5 m	7 m	12 m
130	4 m	7 m	11 m
140	4 m	6 m	10 m
150	4 m	6 m	9 m

WIRING DIAGRAM NR. 1

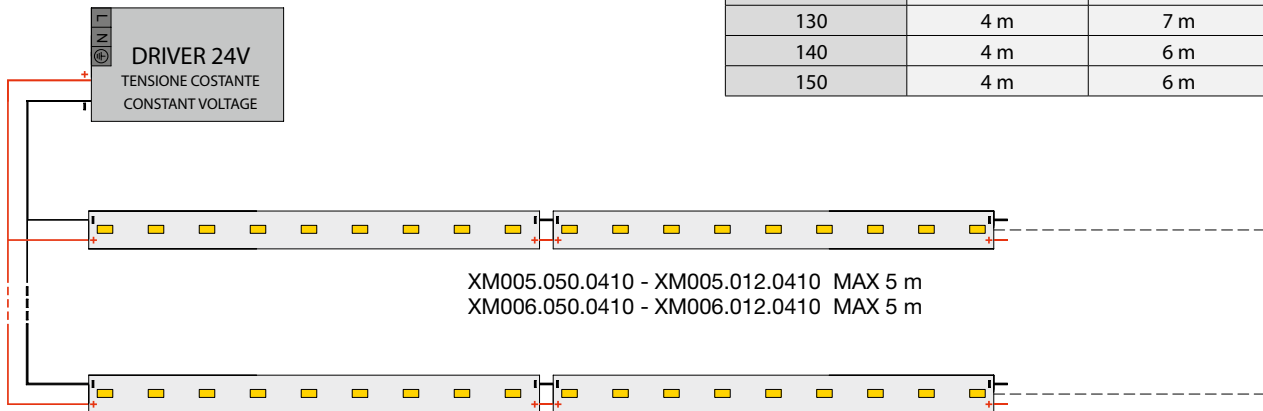

WIRING DIAGRAM NR. 2

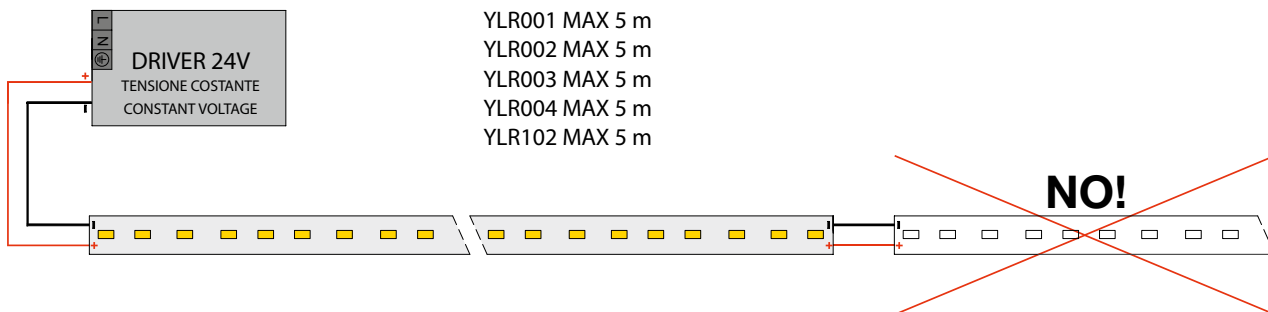

WIRING DIAGRAM NR. 3

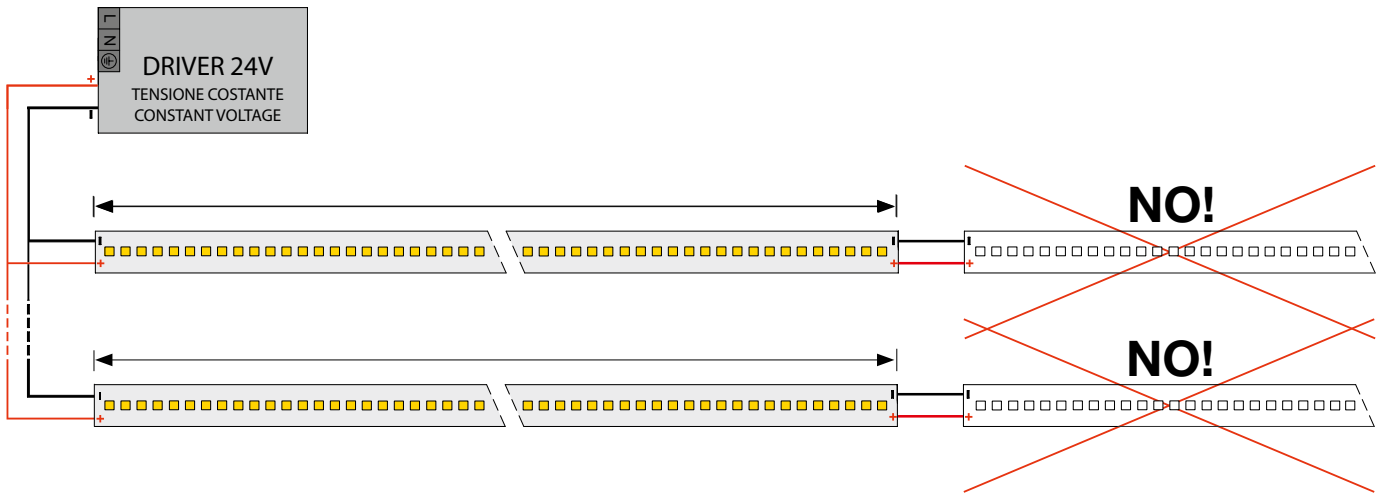

APPARECCHI CON LED A CORRENTE COSTANTE

Il collegamento tra i vari apparecchi/led deve essere effettuato in serie. Il numero di LED per alimentatore dipende dalla potenza e dalla tensione che l'alimentatore rende disponibile. Nonostante l'utilizzo di correnti molto basse è opportuno considerare la distanza tra alimentatori e apparecchi/LED. Segue la tabella 2 che indica la lunghezza/sezione del cavo con alimentazione a corrente costante. Viene indicata la distanza massima tra alimentatore e apparecchi/LED.

FIXTURES USING LEDS WITH A CONSTANT CURRENT

The connection between the various fixtures / LEDs must be carried out in series. The number of LEDs per power supply unit depends on the available power and voltage of the unit. Notwithstanding the use of very low currents, it is advisable to take into consideration the distance between ballasts and fixtures / LEDs. Table 2 (below) indicates the length / section of the cable using a constant current supply. It shows the maximum distance between the power supply and the fixture/LED.

TABELLA 2			
Sezione	1 mm ²	1,5 mm ²	2,5 mm ²
Lunghezza	20 m	30 m	50 m

WIRING DIAGRAM NR. 4

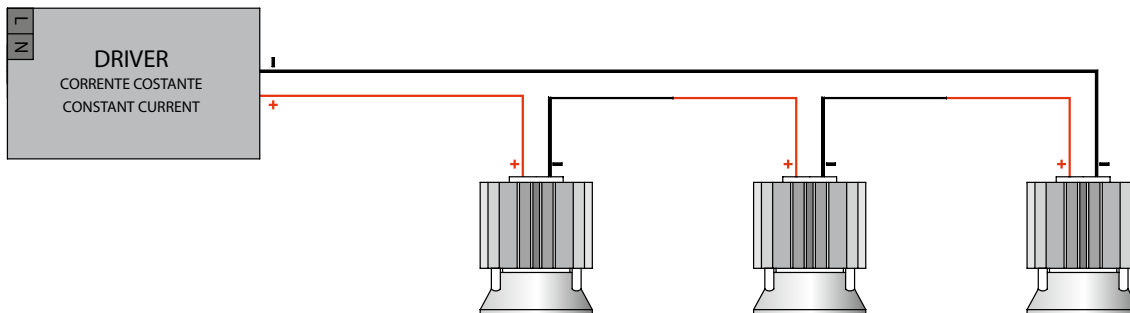

WIRING DIAGRAM NR. 5

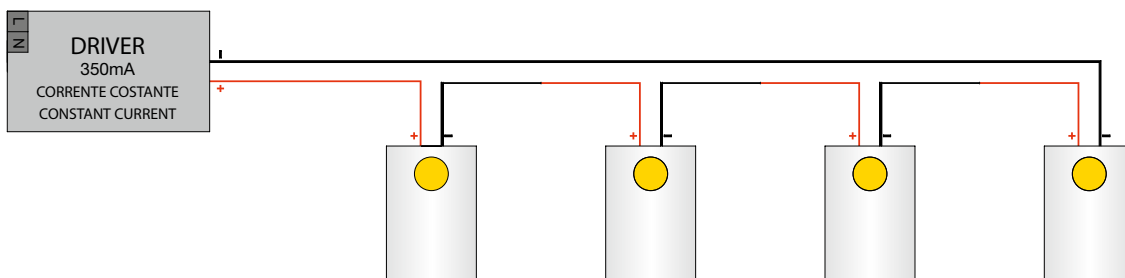

WIRING DIAGRAM NR. 6

YCO.C048.A02

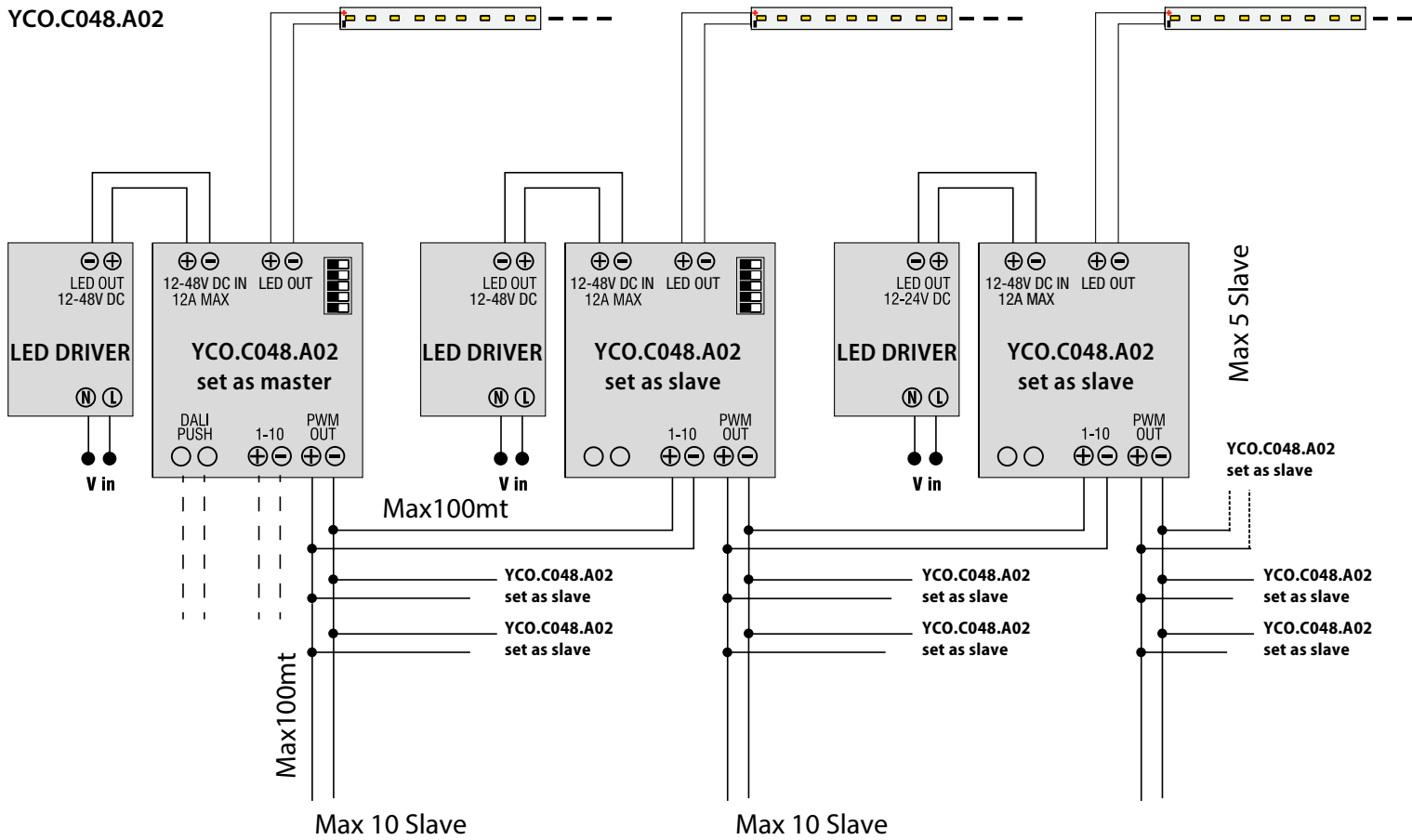

WIRING DIAGRAM NR. 7

YCO.D048.A02

Wiring diagram DALI

Wiring diagram Push

Wiring diagram Trimmer 1/10V

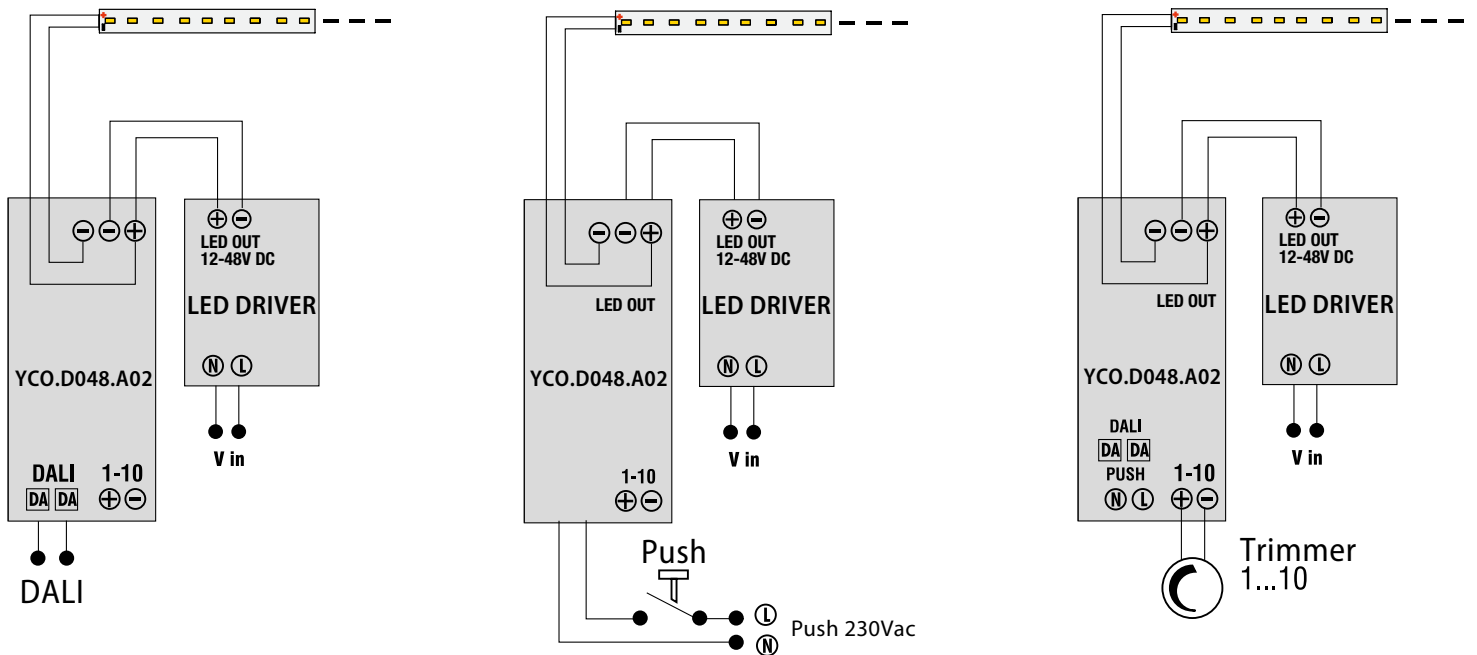

FLUSSO LUMINOSO Φ

Unità di misura: lumen (lm)

Per flusso luminoso si intende l'intera potenza irradiata dalla sorgente luce che viene valutata con la sensibilità spettrale dell'occhio. Il flusso luminoso è una grandezza molto utile per confrontare le lampade tradizionali con i LED.

LUMINOUS FLUX Φ

Unit: lumen (lm)

Luminous flux means the total power radiated by a light source, which is evaluated considering the spectral sensitivity of the eye. The luminous flux is a measurement very useful when comparing traditional lamps with LEDs.

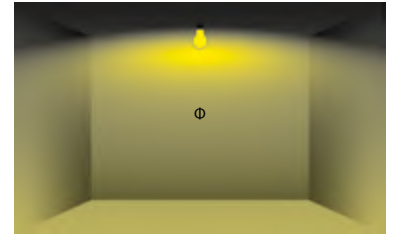

INTENSITÀ LUMINOSA I

Unità di misura: candela (cd)

Una sorgente luminosa irradia il suo flusso luminoso generalmente in diverse direzioni con diversa intensità. L'intensità della luce irradiata in una determinata direzione viene definita intensità luminosa.

LUMINOUS INTENSITY I

Unit: candela (cd)

A light source emits its luminous flux usually in different directions and at different intensities. The intensity of light radiated in a given direction is defined as light intensity.

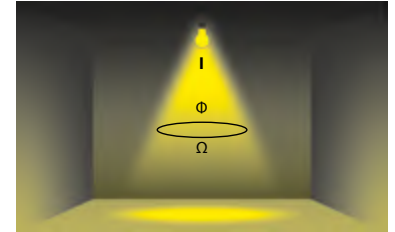

ILLUMINAMENTO E

Unità di misura: lux (lx)

L'illuminamento è dato dal rapporto tra il flusso luminoso irradiato e la superficie illuminata. L'illuminamento prodotto da un flusso luminoso di 1 lm che cade in modo uniforme su una superficie di 1 m² è pari a 1 lx.

ILLUMINANCE E

Unit: lux (lx)

Illuminance is the ratio of the luminous flux and the illuminated surface. The illuminance produced by a luminous flux of 1 lm that falls evenly on a surface of 1 square meter is equal to 1 lx.

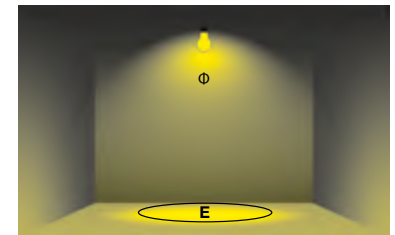

LUMINANZA L

Unità di misura: candela per metro quadrato [cd/m²]

La luminanza L di una sorgente di luce o di una superficie illuminata è determinante per la sensazione di luce percepita.

LUMINANCE L

Unit: candela per square meter [cd/m²]

The luminance L of a light source or an illuminated surface indicates how much luminous power will be detected by an eye looking at the surface from a particular angle of view.

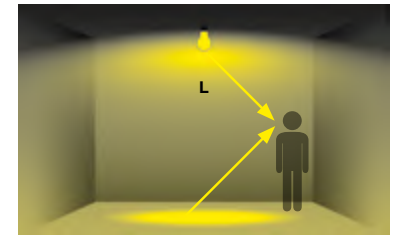

L'EFFICIENZA LUMINOSA

Unità di misura: lumen per watt (lm/W)

L'efficienza luminosa indica il rendimento di una lampada.

Viene espressa dal rapporto fra il flusso luminoso prodotto in lumen e la potenza applicata in watt.

LUMINOUS EFFICACY

Unit: lumens per watt (lm/W)

Luminous efficacy indicates the efficiency of a lamp. It is the ratio between the luminous flux in lumens produced and the applied power in watts.

TEMPERATURA DI COLORE

Unità di misura: kelvin (K)

Temperatura di colore indica la tonalità della luce. Più è alto il valore e più fredda è la tonalità della luce

3000K - tonalità calda

4000K - tonalità neutra

5500K - tonalità diurna

COLOUR TEMPERATURE

Unit: kelvin (K)

Colour temperature indicates a light's tonality: the higher the value, the colder the tone of the light

3000K - warm tone

4000K - neutral tone

5500K - daylight tone

INDICE DI RESA CROMATICA

Ra oppure in inglese Color Rendering Index (CRI)

Si indica come resa cromatica la fedeltà nella riproduzione dei colori sotto una certa illuminazione.

L'indice massimo di 100 rappresenta la resa cromatica ideale.

COLOR RENDERING INDEX

Ra or Color Rendering Index (CRI)

Ra is a quantitative measure of the ability of a light source to reproduce the colors of various objects faithfully in comparison with an ideal or natural light source.

The Ra maximum value 100 equals ideal color rendering.



Prodotto conforme alle norme di sicurezza e alle direttive europee vigenti. **Tutti i prodotti Panzeri sono conformi alle prescrizioni del marchio CE.**
Product complying with safety rules and EU directives. **All Panzeri's products are compliant with CE mark requirements.**



Apparecchio in classe II
Apparecchio nel quale la protezione contro la scossa elettrica non si basa unicamente sull'isolamento fondamentale, ma anche sulle misure supplementari di sicurezza costituite dal doppio isolamento o dall'isolamento rinforzato. Queste misure non comportano dispositivi per la messa a terra e non dipendono dalle condizioni di installazione.
Class II Fixture
A fixture for which protection against an electric shock does not rely only on basic insulation but also offers further safety measures, such as double insulation or reinforced insulation.
These measures do not require grounding devices and are not dependent upon installation conditions.



Apparecchio in classe III
Apparecchio in cui la protezione contro la scossa elettrica si basa sull'alimentazione a bassissima tensione di sicurezza e in cui non si generano tensioni superiori alla stessa.
Nota: un apparecchio in classe III non deve essere provvisto di messa a terra.
Class III Fixture
A fixture in which protection against an electric shock is guaranteed by the extremely low and safe voltage level of the power supply, which does not generate higher voltage levels. NB: a Class III fixture does not require grounding protection.

IP..

Grado di protezione
Il grado di protezione degli apparecchi di illuminazione viene indicato con la sigla "IP" seguita da due cifre caratteristiche.
- la prima indica la protezione contro la penetrazione dei corpi solidi e della polvere
- la seconda indica la protezione contro la penetrazione dei liquidi
Protection Index
The protection rating of the lighting appliances is shown by the letters "IP" followed by two characteristic digits
- the first of these two digits indicates the degree of protection that the appliances offer against the entry of solid foreign objects
- the second one indicates the protection against the entry of water

IK

Grado di protezione degli involucri per apparecchiature elettriche contro impatti meccanici esterni (codice IK)
Degree of protection provided by enclosures for electrical equipment against external mechanical impacts (IK code)



Lampadina protetta contro esplosioni
Lamp protected against explosion

RoHS

RoHS - DIRETTIVA 2002/95/CE (Restriction of the use of certain Hazardous Substances in electrical and electronic equipment) Direttiva europea che limiti l'utilizzo di alcune sostanze pericolose (piombo, cadmio, mercurio, cromo esavalente, bifenile polibromurati, Eteri difendi polibromurati. A partire da 1 luglio 2006 tali sostanze non possono essere più impiegate nei prodotti elettrici ed elettronici, salvo deroghe su alcune applicazioni.
RoHS - DIRECTIVE 2002/95/CE (Restriction of the use of certain Hazardous Substances in electrical and electronic equipment). The European Directive restricts the use of some dangerous substances: lead, mercury, cadmium, hexavalent chromium, polybrominated biphenyls (PBB) or polybrominated diphenyl ethers (PBDE). From 1st July 2006 such substances shall not be used anymore in electrical and electronic equipment apart from exceptions on specific applications.

EAC

Marchio unico di certificazione EAC (EurAsian Certification) che sostituisce i marchi nazionali GOST (R per la Russia, B per Bielorussia e K per Kazakistan)
Unique brand of EAC certification (Eurasian Certification) which replaces the national GOST brands (R for Russia, B for Belarus and K for Kazakhstan).

SELV

Bassissima tensione di sicurezza
Safety Extra Low Voltage

1...10V

Dimmer analogico con segnale di tensione continua 1...10V
Analogic dimmer with a direct voltage signal



Dimmer a taglio di fase ascendente/discendente (TRIAC)
Phase cutting dimmer leading edge, trailing edge (TRIAC)

DALI

Dimmer digitale con interfaccia DALI
Digital dimmer with DALI interface

DALI/PUSH DIM

Dimmer con funzionalità DALI o pulsante normalmente aperto NA
Dimmer for DALI protocol or push button application

PUSH DIM

Dimmer con pulsante normalmente aperto NA
Dimmer with push button NO

STEP DIM

Step Dim: accensione massima + 3 livelli di dimmerazione + spegnimento tramite sensore touch.
Step Dim: max on + 3 dimming levels + off through touch sensor.



Alimentatore idoneo al montaggio indipendente
Independent driver can be mounted separately outside a luminaire

1H/12H EMERGENCY

Emergenza integrata. Autonomia 1h / Tempo di ricarica 12h
Integrated emergency. Duration 1h/Recharging time 12h

850°

Prova del filo incandescente a 850°C.
Glow wire test at 850° degree.

CONSORZIO PER LA RACCOLTA E LO SMALTIMENTO DELLE APPARECCHIATURE DI ILLUMINAZIONE

PANZERI CARLO SRL ADERISCE AL CONSORZIO ECOLIGHT - MILANO ITALY

WEEE - DIRETTIVA 2002/96/CE, 2003/108/CE (WASTE ELECTRICAL AND ELECTRONIC EQUIPMENT) RIFIUTI DI APPARECCHI ELETTRICI ED ELETTRONICI.

La direttiva valida su tutto il territorio dell'Unione Europea definisce una serie di misure allo scopo di prevenire la produzione di rifiuti di apparecchiature elettriche ed elettroniche; di promuovere il riutilizzo, il riciclo ed altre forme di recupero di tali tipologie di rifiuti; di limitare i rischi di impatto sull'ambiente derivanti dal trattamento e dallo smaltimento dei rifiuti in questione; di armonizzare le misure nazionali di gestione dei rifiuti elettrici ed elettronici.

Gli apparecchi di illuminazione marcati con l'apposito simbolo del cassonetto barrato  sono soggetti a raccolta differenziata separata dal resto dei rifiuti urbani.

Per la restituzione di un dispositivo dimesso, occorre servirsi dei sistemi di restituzione e di raccolta messi a disposizione nei singoli paesi di utilizzo.

PANZERI CARLO SRL JOINS CONSORZIO ECOLIGHT - MILANO ITALY

WEEE - DIRECTIVE 2002/96/CE, 2003/108/CE (WASTE ELECTRICAL AND ELECTRONIC EQUIPMENT).

The European Directive is applicable throughout the European Union and determines the measures in order to prevent the production of waste electrical and electronic equipment; to promote the re-use, the recycle and other forms of reutilization of these kind of waste; to restrict the risks of impact to the environment coming from treatment and disposal of these equipments; to harmonize national measures of managing waste electrical and electronic equipment.

Equipment marked with proper symbol of crossed container  may not be disposed of with household rubbish.

To return the used device, the return and collection systems available in every single Country must be used.

CONDIZIONI DI VENDITA

Alle vendite si applicano le condizioni generali di vendita e la garanzia pubblicati sul nostro sito internet www.panzeri.it alla data di accettazione dell'ordine da parte di Panzeri Carlo SRL

SALES CONDITIONS

Sales are regulated by the general export sales conditions and warranty published on our website www.panzeri.it at the time of confirmation of the order by Panzeri Carlo SRL



ADERENTE AD ASSOLOMBARDA
CONFINDUSTRIA MILANO MONZA E BRIANZA



Riconoscimento attribuito per oltre 50 anni di attività
Recognition given for over 50 years of continuous activity



ADIMEMBER

ADI ASSOCIAZIONE PER IL DISEGNO INDUSTRIALE

AIDI
Associazione
Italiana
di Illuminazione

Pur mantenendo inalterate le proprie caratteristiche di base, i nostri articoli possono risultare parzialmente modificati rispetto a come sono raffigurati nel presente catalogo. Ciò è dovuto all'evoluzione a cui sottoponiamo i prodotti, con lo scopo di un miglioramento continuo. Anche i colori presentati nel catalogo sono da considerarsi puramente indicativi.

While maintaining the basic characteristics of the product, the Company reserves the right to make modifications at any time with the sole aim of improvement. The colours illustrated in the catalogue are intended only as examples.

PANZERI

PANZERI CARLO S.R.L.

Via Padania, 8 - 20853
Biassono MB - Italy
Sede Legale:
Via Mameli, 11 - 20851
Lissone MB - Italy
T +39 039 2497483
F +39 039 2497396
panzeri@panzeri.it
export@panzeri.it
panzeri.it

Show-room Milano

Arena Listone Giordano
Via S. Cecilia, 6 - 20122
Milano - Italia

PANZERI & PARTNERS GMBH

Karlsplatz 3 - 80335
München - Deutschland
T +49 89 209 607 40
F +49 89 209 607 41
info@panzeri-partners.de
panzeri-partners.de

Show-room München

Karlsplatz 3 - 80335
München - Deutschland

PANZERI FRANCE SAS

31 rue Laure Diebold
Parc d'activité Greenopolis
69009 Lyon 09 - France
FR77 889 971 271
jmsa@panzeri-france.fr
panzeri-france.fr

Show-room Paris

179 Rue Lecourbe - 75015
Paris - France

PANZERI MIDDLE EAST DMCC

Preatoni Tower, Office 2506
Cluster L, JLT, Dubai, UAE,
PO Box 7042
panzeri-me.com

PEGGY GUGGENHEIM COLLECTION

Panzeri, nell'ambito del proprio programma di Responsabilità Sociale d'Impresa, supporta la Collezione Peggy Guggenheim di Venezia aderendo al programma Officinæ Guggenheim.

Panzeri, in its Corporate Social Responsibility program, supports the Peggy Guggenheim Collection of Venice, joining to Officinæ Guggenheim program.



PANZERI.IT