

Pendant lamp Rim 3000K 88W

Series: Rim Article: MOD058PL-L74BS3K

Article	MOD058PL-L74BS3K
Brand	Maytoni
Collection	Modern
Series	The model is shaped as a metal ring. The series is represented by luminaires of various sizes in 3 colours: white, black and brass. LED light sources
Product type	Pendant lamp
Fitting color	Brass
Fitting material	Aluminum
Number of lamps	2
Color temperature	3000
IP protection	IP 20
Dimmable	No
Height	1000
Color rendering index	85
Scattering angle	120
Voltage	AC 220-240
Diameter	800
Protection level	Class1
Warranty	3
Power	88
Minimum height	100
Max Height	1200

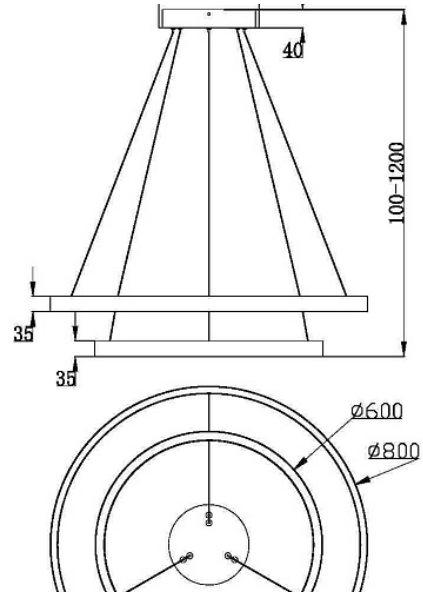

Lamps included	No
Light flux	5200
Mounting bowl	Yes
Chain	No
Type of fastener	Bar
Base	No
Switch	No
Dome lamp switch	No
Energy efficiency class	A
Fireproof	No
Dyed	No
Lampshade	Yes
Packing length	95
Volume	70262
Net	6
Gross	6.33